



JESTEŚMY POLSKĄ FIRMA, KTÓRA POSIADA PONAD 35-LETNIE DOŚWIADCZENIE W BRANŻY. OD SAMEGO POCZĄTKU WSPÓŁPRACUJEMY JEDYNIEM Z SPRAWDZONYMI EUROPEJSKIMI PRODUCENTAMI, KTÓRYCH FABRYKI ZNAJDUJĄ SIĘ WE WŁOSZECH I NIEMCZECH.



## CHROM CHROME

FIN A FIN B BICOLOR

### FIN A



### FIN B



### BICOLOR Dla kolekcji FUSION FOR FUSION ONLY



## INOX STEEL

PVD

### PVD Dla kolekcji STEEL FOR STEEL ONLY



## PALETA KOLORYSTYCZNA

Wszystkie mosiężne produkty możemy wyprodukować w dowolnym kolorze z palety FIN A oraz FIN B.

Kolekcja FUSION z dodatkową paletą BICOLOR. Kolekcja STEEL w wykończeniach PVD.

Stwórz swoją wymarzoną łazienkę z produktami Daniel Rubinetterie

**DANIEL**  
RUBINETTERIE  
MILANO



DANIEL  
RUBINETTERIE  
MILANO



CRISTINA  
RUBINETTERIE



[WWW.PAFFONI.IT](http://WWW.PAFFONI.IT)

[WWW.DANIEL.IT](http://WWW.DANIEL.IT)

[WWW.EMMEVI.IT](http://WWW.EMMEVI.IT)

[WWW.CRISTINARUBINETTERIE.COM](http://WWW.CRISTINARUBINETTERIE.COM) - CENNIK PRODUCENTA

[WWW.PAINI.COM](http://WWW.PAINI.COM) - CENNIK PRODUCENTA

[WWW.BONOMINI.COM](http://WWW.BONOMINI.COM)

[WWW.BENKISER.DE](http://WWW.BENKISER.DE)

## ZALECENIA DOTYCZĄCE UTRZYMANIA CZYSTOŚCI I KONSERWACJI POWŁOKI

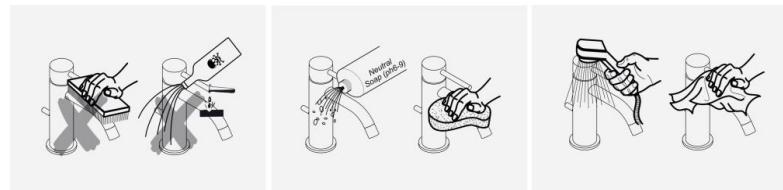

**ABY SPROSTAĆ OCZEKIWIANIOM KLIENTÓW WSPÓŁPRACUJEMY JEDYNIEM ZE SPRAWDZONYMI PRODUCENTAMI ARMATURY SANITARNEJ. TYM NIE MNIEJ PRAWIDŁOWY MONTAŻ, CZYSZCZENIE I PIELĘGNACJA SĄ NIEZBĘDNE DO ZACHOWANIA WŁAŚCIWOŚCI ESTETYCZNYCH PRZEZ DŁUGIE LATA.**

- W CELU ZACHOWANIA CZYSTOŚCI POWŁOKI NALEŻY STOSOWAĆ JEDYNIEM MYDŁO O NEUTRALNYM PH, CIEPLĄ WODĘ ORAZ MIEKKĄ SZMATKĘ. PRODUKTY ZAWSZE NALEŻY DOKŁADNIE SPŁUKAĆ WODĄ,  
- NIE MOŻNA DOPUŚCIĆ DO OSADZANIA SIĘ KAMIENIA Z WODY WODOCIĄGOWEJ/ZWIĄZKÓW SOLI Z UKŁADÓW FILTRACYJNYCH KTÓRY PO PRZYWARCIU DO POWŁOKI MOŻE SKUTKOWAĆ ODSPAJANIEM I

ZNISZCZENIEM POWŁOKI,

- ZABRANIA SIĘ UŻYWANIA ŚRODKÓW ZAWIERAJĄCYCH KWASY, ALKOHOL ITP. A TAKŻE ŚCIERCZEK Z MIKROFIBRY ORAZ SZORSTKICH GĄBEK. SZCZEGÓŁOWE INFORMACJE ZNAJDUJĄ SIĘ W KARTACH GWARANCYJNYCH PRODUCENTÓW ORAZ NA STRONIE [WWW.ARPOL.COM.PL](http://WWW.ARPOL.COM.PL) W ZAKŁADCE SERWIS.

	STRONA W CENNIKU	BIAŁY MAT	CZARNY MAT	STAL SZCZOTKOWANA	GRAFITOWY	ZŁOTY BŁYSZCZĄCY	ZŁOTY SZCZOTKOANY	RÓŻOWE ZŁOTO	TUSCAN (BRĄZ SZCZOTKOWANY)	MIEDŹ SZCZOTKOWANA	STARE ZŁOTO	GUNMETAL	INNE
ELLE	-1-		•										
LEVEL	-12-			•									
TILT	-22-	•	•	•									
TANGO	-27-		•	•									
ROCK	-32-			•									
RINGO	-36-		•										
STICK	-45-			•									
JO	-55-		•										
JOKER	-55-		•										
LIGHT	-62-	•	•	•	•	•	•	•		•		•	
FLAVIA/GIORGIA	-96-									•	•		•
BELINDA	-99-					•				•	•		•
IRIS	-103-					•					•		•
DREAM	-108-	•	•	•		•	•			•	•	•	•
INFINITY	-111-	•	•	•		•	•			•	•	•	•
ENERGY	-114-	•	•	•		•	•			•	•	•	•
OMEGA	-117-	•	•	•		•	•			•	•	•	•
CHRONO	-122-	•	•	•		•	•			•	•	•	•
TOKYO	-124-	•	•	•		•	•			•	•	•	•
DIVA	-134-	•	•	•		•	•			•	•	•	•
SWING	-138-	•	•	•		•	•			•	•	•	•
BROOKLYN	-141-	•	•	•		•	•			•	•	•	•
RETRO	-144-	•	•	•		•	•			•	•	•	•
ARES	-147-	•	•	•		•			•		•	•	
LAGUNA	-150-					•				•	•		
TIFFANY	-156-					•				•	•		•
SPIRIT NEW	-159-	•	•		•	•	•			•	•		
PIPER	-161-	•	•	•	•	•	•			•	•	•	
FILO	-171-	•	•		•		•		•			•	
NICLA	-176-		•		•				•	•	•	•	
NEFER	-179-	•	•	•	•					•		•	
MINU	-181-	•	•									•	
SIRIS	-183-		•	•	•					•		•	
DECO	-186-	•	•	•	•					•		•	

-  - PRODUKTY DOSTĘPNE NA STANACH MAGAZYNOWYCH W POLSCE  
 - CZAS REALIZACJI PRODUKTÓW POD ZAMÓWIENIE JEST CZASEM ORIENTACYJNYM I NIE JEST WIĄŻĄCY  
 - PRODUKTY NIE PODLEGAJĄ ZWROTOM/MODYFIKACJOM/ANULACJOM  
 - ZASTRZEGAMY SOBIE PRAWO DO ZMIANY CECH PRODUKTÓW ORAZ ICH CEN BEZ PRZEDRUKU CENNIKA



UCHWYT **ELLE** – INDEKS **EL**

UCHWYT **EFFE** – INDEKS **EF**

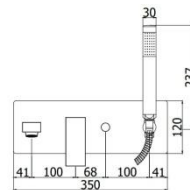

**EL/EF001..** BATERIA WANNOWA PODTYNKOWA ZESPOLONA

**CR** CHROM 2100,00  
**NO** CZARNY MAT 2850,00

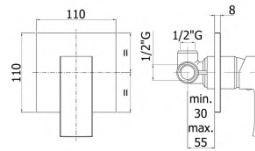

**EL/EF010..** BATERIA PODTYNKOWA 1-DROŻNA

**CR** CHROM 320,00  
**NO** CZARNY MAT 550,00

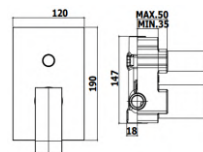

**EL/EF015..** BATERIA PODTYNKOWA 2-DROŻNA

**CR** CHROM 580,00  
**NO** CZARNY MAT 1050,00

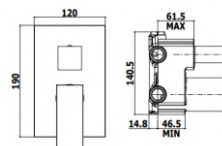

**EL/EF018..** BATERIA PODTYNKOWA 2-DROŻNA Z PRZEŁĄCZNIKIEM MECHANICZNYM

**EL/EF019..** BATERIA PODTYNKOWA 3-DROŻNA Z PRZEŁĄCZNIKIEM MECHANICZNYM

**CR** CHROM 1020,00  
**NO** CZARNY MAT 1600,00

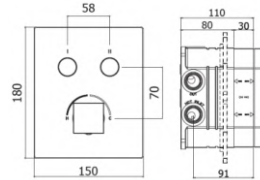

**CPM518..** BATERIA PODTYNKOWA 2-DROŻNA (CPBOX)  
**CPM519..** BATERIA PODTYNKOWA 3-DROŻNA (CPBOX)

**CR** CHROM 2600,00  
**NO** CZARNY MAT 3200,00

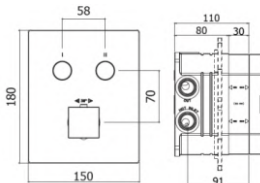

**CPT513..** BATERIA PODTYNKOWA TERMOBAT 1-DROŻNA (CPBOX)  
**CPT518..** BATERIA PODTYNKOWA TERMOBAT 2-DROŻNA (CPBOX)  
**CPT519..** BATERIA PODTYNKOWA TERMOBAT 3-DROŻNA (CPBOX)

**CR** CHROM 2800,00  
**NO** CZARNY MAT 3700,00

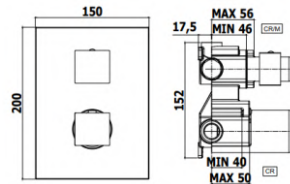

**LEQ513..** BATERIA PODTYNKOWA TERMOBAT 1-DROŻNA  
**LEQ518..** BATERIA PODTYNKOWA TERMOBAT 2-DROŻNA  
**LEQ519..** BATERIA PODTYNKOWA TERMOBAT 3-DROŻNA

**CR** CHROM 1950,00  
**NO** CZARNY MAT 2650,00

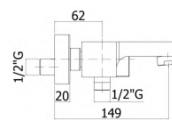

**EL/EF022..** BATERIA WANNOWA ŚCIENNA (KORPUS)  
**EL/EF023..** BATERIA WANNOWA ŚCIENNA (KOMPLETNA)

**INDEKS EL022 LUB EF022**  
**CR** CHROM 1025,00  
**NO** CZARNY MAT 1380,00  
**INDEKS EL023 LUB EF023**  
**CR** CHROM 1210,00  
**NO** CZARNY MAT 1550,00

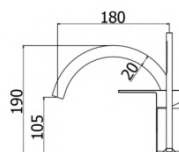

**EL/EF040..** BATERIA WANNOWA 3-OTWOROWA  
**EL/EF041..** BATERIA WANNOWA 2-OTWOROWA (BEZ WYLEWKI)

**INDEKS EL040 LUB EF040**  
**CR** CHROM 2150,00  
**NO** CZARNY MAT 2850,00

**INDEKS EL041 LUB EF041**  
**CR** CHROM 1350,00

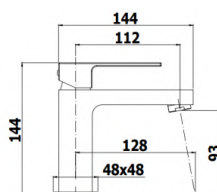

**EL/EF071..** BATERIA UMYWALKOWA STOJĄCA (BEZ KORKA)  
**EL/EF071K..** BATERIA UMYWALKOWA STOJĄCA (KOREK CLICK CLACK)

**INDEKS EL071 LUB EF071**  
**CR** CHROM 590,00  
**NO** CZARNY MAT 780,00

**INDEKS EL071K LUB EF071K**  
**CR** CHROM 670,00  
**NO** CZARNY MAT 900,00

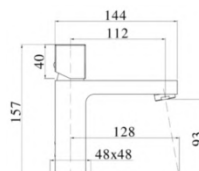

**ELX071..** BATERIA UMYWALKOWA STOJĄCA (BEZ KORKA)  
**ELX071K..** BATERIA UMYWALKOWA STOJĄCA (KOREK CLICK CLACK)

**INDEKS ELX071**  
**CR** CHROM 670,00

**INDEKS ELX071K**  
**CR** CHROM 740,00

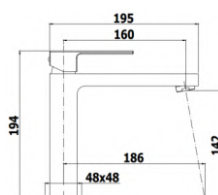

**EL/EF074..** BATERIA UMYWALKOWA STOJĄCA XL (BEZ KORKA)  
**EL/EF074K..** BATERIA UMYWALKOWA STOJĄCA XL (KOREK CLICK CLACK)

**INDEKS EL074 LUB EF074**  
**CR** CHROM 740,00  
**NO** CZARNY MAT 1020,00

**INDEKS EL074K LUB EF074K**  
**CR** CHROM 820,00  
**NO** CZARNY MAT 1140,00

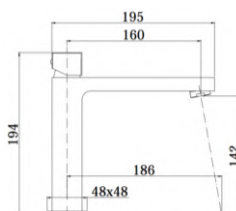

**ELX074..**  
**ELX074K..**

BATERIA UMYWALKOWA STOJĄCA **XL** (BEZ KORKA)  
BATERIA UMYWALKOWA STOJĄCA **XL** (KOREK CLICK CLACK)

**INDEKS ELX074**  
**CR** CHROM **860,00**

**INDEKS ELX074K**  
**CR** CHROM **930,00**

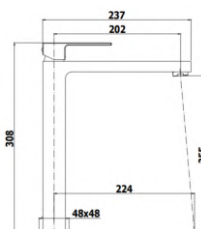

**EL/EF081..**  
**EL/EF081K..**

BATERIA UMYWALKOWA WYSOKA (BEZ KORKA)  
BATERIA UMYWALKOWA WYSOKA (KOREK CLICK CLACK)

**INDEKS EL081 LUB EF081**  
**CR** CHROM **1240,00**  
**NO** CZARNY MAT **1580,00**

**INDEKS EL081K LUB EF081K**  
**CR** CHROM **1320,00**  
**NO** CZARNY MAT **1700,00**

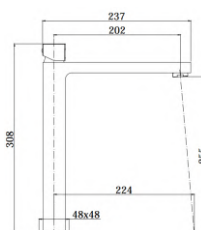

**ELX081..**  
**ELX081K..**

BATERIA UMYWALKOWA WYSOKA (BEZ KORKA)  
BATERIA UMYWALKOWA WYSOKA (KOREK CLICK CLACK)

**INDEKS ELX081**  
**CR** CHROM **1320,00**

**INDEKS ELX081K**  
**CR** CHROM **1400,00**

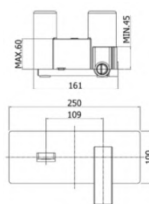

**EL/EF104..**  
**EL/EF105..**  
**EL/EF106..**

BATERIA UMYWALKOWA PODTYNKOWA **L-150MM**  
BATERIA UMYWALKOWA PODTYNKOWA **L-200MM**  
BATERIA UMYWALKOWA PODTYNKOWA **L-240MM**

**CR** CHROM **1370,00**

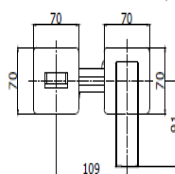

**EL/EF104..70** BATERIA UMYWALKOWA PODTYNKOWA L-150MM  
**EL/EF105..70** BATERIA UMYWALKOWA PODTYNKOWA L-200MM  
**EL/EF106..70** BATERIA UMYWALKOWA PODTYNKOWA L-240MM

**CR** CHROM 1320,00  
**NO** CZARNY MAT 1800,00

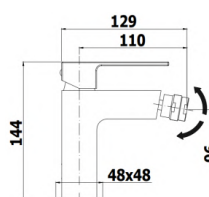

**EL/EF131..** BATERIA BIDETOWA STOJĄCA (BEZ KORKA)  
**EL/EF131K..** BATERIA BIDETOWA STOJĄCA (KOREK CLICK CLACK)

**INDEKS EL131 LUB EF131**  
**CR** CHROM 590,00  
**NO** CZARNY MAT 780,00

**INDEKS EL131K LUB EF131K**  
**CR** CHROM 670,00  
**NO** CZARNY MAT 900,00

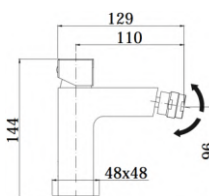

**ELX131..** BATERIA BIDETOWA STOJĄCA (BEZ KORKA)  
**ELX131K..** BATERIA BIDETOWA STOJĄCA (KOREK CLICK CLACK)

**INDEKS ELX131**  
**CR** CHROM 670,00

**INDEKS ELX131K**  
**CR** CHROM 740,00

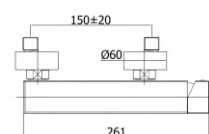

**EL/EF168..** BATERIA NATRYSKOWA ŚCIENNA (KORPUS)  
**EL/EF168D..** BATERIA NATRYSKOWA ŚCIENNA (KOMPLETNA)

**INDEKS EL168 LUB EF168**  
**CR** CHROM 760,00  
**NO** CZARNY MAT 970,00

**INDEKS EL168D LUB EF168D**  
**CR** CHROM 930,00  
**NO** CZARNY MAT 1200,00



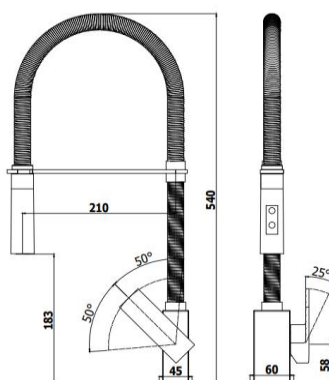

**EL/EF179..**

BATERIA ZLEWOZMYWAKOWA STOJĄCA Z WĘŻEM OPERACYJNYM

**INDEKS EL179 LUB EF179**  
**CR CHROM 1630,00**

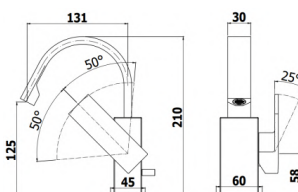

**EL/EF838..**

BATERIA STOJĄCA NISKA (BEZ KORKA)

**EL/EF838K..**

BATERIA STOJĄCA NISKA (KOREK CLICK CLACK)

**INDEKS EL838 LUB EF838**  
**CR CHROM 1200,00**

**INDEKS EL838K LUB EF838K**  
**CR CHROM 1280,00**

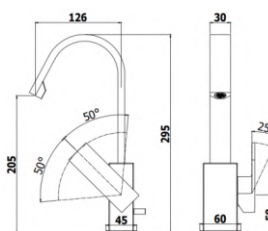

**EL/EF878..**

BATERIA STOJĄCA WYSOKA (BEZ KORKA)

**EL/EF878K..**

BATERIA STOJĄCA WYSOKA (KOREK CLICK CLACK)

**INDEKS EL878 LUB EF878**  
**CR CHROM 1250,00**

**INDEKS EL878K LUB EF878K**  
**CR CHROM 1330,00**

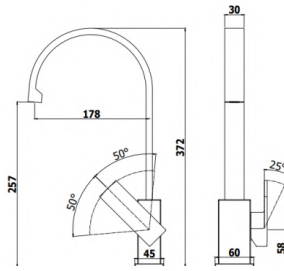

**EL/EF880..** BATERIA ZLEWOZMYWAKOWA STOJĄCA

**CR** CHROM

**1390,00**

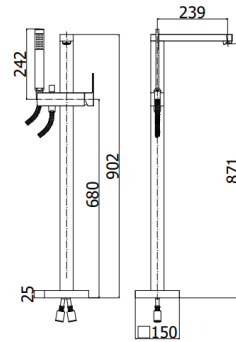

**EL/EF033..** BATERIA WANNOWA WOLNOSTOJĄCA (KOMPLETNA)

**\*CR** CHROM

**7700,00**

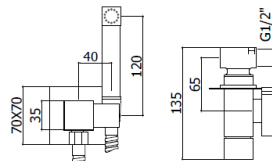

**22685** BATERIA BIDETOWA PODTYNKOWA VIOLA (KOMPLETNA)

**INDEKS 22685**

**CR** CHROM **600,00**

**ZDUP112** BATERIA BIDETOWA PODTYNKOWA VIOLA (KOMPLETNA) CZARNY MAT

**INDEKS ZDUP112**

**NO** CZARNY MAT **800,00**



SKŁAD ZESTAWU:  
- ZESTAW 3w1 ZDUP095  
- WYLEWKA ŚCIENNA SK4704 -DANIEL-



**EL/EF015ZWW..** ZESTAW WANNOWY PODTYNKOWY (WYLEWKA L-170MM)

**CR** CHROM  
**NO** CZARNY MAT

**1555,00**  
**2650,00**



**SKŁAD ZESTAWU:**  
 - ZESTAW 3w1 ZDUP095  
 - SYFON WANNOWY Z NAPEŁNIENIEM D6 -CRS-



**EL/EF015ZWS..**

ZESTAW WANNOWY PODTYNKOWY Z NAPEŁNIENIEM PRZEZ PRZELEW

<b>CR</b>	CHROM	<b>1415,00</b>
<b>NO</b>	CZARNY MAT	<b>2370,00</b>



**SKŁAD ZESTAWU:**  
 - DESZCZOWNICA:  
 (INDEKS A) ZSOF075 **200x200MM**  
 (INDEKS B) SNK300 **300x300MM, SLIM -AP-**  
 (INDEKS E) C06658 **300x300MM -EMMEVI-**  
 - RAMIĘ ŚCIENNE L-400MM  
 - ZESTAW 3w1 ZDUP095  
 - WYLEWKA ŚCIENNA SK4704 L-170MM -DANIEL-



	<b>INDEKS A</b>	ZSOF075	<b>200x200mm</b>
<b>A.CR</b>		CHROM	<b>2835,00</b>
<b>A.NO</b>		CZARNY MAT	<b>4700,00</b>

	<b>INDEKS B</b>	SNK300	<b>300x300mm</b>
<b>B.CR</b>		CHROM	<b>2755,00</b>

	<b>INDEKS E</b>	C06658	<b>300x300mm</b>
<b>E.CR</b>		CHROM	<b>3155,00</b>
<b>E.NO</b>		CZARNY MAT	<b>5200,00</b>

**EL/EF019ZSCW3..**

ZESTAW WANNOWY PODTYNKOWY



**SKŁAD ZESTAWU:**  
 - DESZCZOWNICA:  
 (INDEKS A) ZSOF075 **200x200MM**  
 (INDEKS B) SNK300 **300x300MM, SLIM -AP-**  
 (INDEKS E) C06658 **300x300MM -EMMEVI-**  
 - RAMIĘ ŚCIENNE L-400MM  
 - ZESTAW 3w1 ZDUP095  
 - SYFON WANNOWY Z NAPEŁNIENIEM D6 -CRS-



	<b>INDEKS A</b>	ZSOF075	<b>200x200mm</b>
<b>A.CR</b>		CHROM	<b>2695,00</b>
<b>A.NO</b>		CZARNY MAT	<b>4450,00</b>

	<b>INDEKS B</b>	SNK300	<b>300x300mm</b>
<b>B.CR</b>		CHROM	<b>2615,00</b>

	<b>INDEKS E</b>	C06658	<b>300x300mm</b>
<b>E.CR</b>		CHROM	<b>3015,00</b>
<b>E.NO</b>		CZARNY MAT	<b>4950,00</b>

**EL/EF019ZWSCSU3..**

ZESTAW WANNOWY PODTYNKOWY Z NAPEŁNIENIEM PRZEZ PRZELEW



**SKŁAD ZESTAWU:**  
 - DESZCZOWNICA:  
 (INDEKS A) ZSOF075 200x200MM  
 (INDEKS B) SNK300 300x300MM, SLIM -AP-  
 (INDEKS E) C06658 300x300MM -EMMEVI-  
 (INDEKS F) SNK250 250x250MM, SLIM -AP-  
 - RAMIĘ ŚCIENNE L-400MM  
 - ZESTAW 3W1 ZDUP095

**EL/EF015ZSC3..** ZESTAW NATRYSKOWY PODTYNKOWY



**INDEKS A** ZSOF075 200x200mm  
**A.CR** CHROM 1775,00  
**A.NO** CZARNY MAT 2915,00

**INDEKS B** SNK300 300x300mm  
**B.CR** CHROM 1695,00

**INDEKS E** C06658 300x300mm  
**E.CR** CHROM 2095,00  
**E.NO** CZARNY MAT 3715,00

**INDEKS F** SNK250 250x250mm  
**F.CR** CHROM 1615,00



**SKŁAD ZESTAWU:**  
 - DESZCZOWNICA:  
 (INDEKS A) ZSOF075 200x200MM  
 (INDEKS B) SNK300 300x300MM, SLIM -AP-  
 (INDEKS E) C06658 300x300MM -EMMEVI-  
 (INDEKS F) SNK250 250x250MM, SLIM -AP-  
 - RAMIĘ ŚCIENNE L-400MM  
 - ZESTAW 3W1 ZDUP095

**CPM518ZSC3..** ZESTAW NATRYSKOWY PODTYNKOWY



**INDEKS A** ZSOF075 200x200mm  
**A.CR** CHROM 3800,00  
**A.NO** CZARNY MAT 4715,00

**INDEKS B** SNK300 300x300mm  
**B.CR** CHROM 3715,00

**INDEKS E** C06658 300x300mm  
**E.CR** CHROM 4120,00  
**E.NO** CZARNY MAT 5905,00

**(indeks F) SNK250** 250x250mm  
**F.CR** CHROM 3635,00



**SKŁAD ZESTAWU:**  
 - DESZCZOWNICA:  
 (INDEKS A) ZSOF075 200x200MM  
 (INDEKS B) SNK300 300x300MM, SLIM -AP-  
 (INDEKS E) C06658 300x300MM -EMMEVI-  
 (INDEKS F) SNK250 250x250MM, SLIM -AP-  
 - RAMIĘ ŚCIENNE L-400MM  
 - ZESTAW 3W1 ZDUP095

**CPT518ZSC3..** ZESTAW NATRYSKOWY PODTYNKOWY **TERMOSTAT**



**INDEKS A** ZSOF075 200x200mm  
**A.CR** CHROM 3995,00  
**A.NO** CZARNY MAT 5030,00

**INDEKS B** SNK300 300x300mm  
**B.CR** CHROM 3915,00

**INDEKS E** C06658 300x300mm  
**E.CR** CHROM 4315,00  
**E.NO** CZARNY MAT 6405,00

**INDEKS F** SNK250 250x250mm  
**F.CR** CHROM 3835,00



**SKŁAD ZESTAWU:**  
 -DESZCZOWNICA:  
 ZSOF301 **500x500MM** (CHROM)  
 A579EFCM44 **440x440MM** (CZARNY MAT) -DANIEL-  
 - ZESTAW 3w1 ZDUP095



**CR** CHROM  
**NO** CZARNY MAT

**EL/EF018ZES01..**

ZESTAW NATRYSKOWY PODTYNKOWY

**5000,00**

**6250,00**



**SKŁAD ZESTAWU:**  
 - DESZCZOWNICA:  
 (INDEKS A) ZSOF075 **200x200MM**  
 (INDEKS B) SNK300 **300x300MM, SLIM** -AP-  
 (INDEKS F) SNK250 **250x250MM, SLIM** -AP-  
 - RAMIĘ ŚCIENNE **L-400MM**  
 - PODŁĄCZENIE PODTYNKOWE ZACC238CR  
 - ZESTAW NATRYSKOWY ZSAL079



**INDEKS A** ZSOF075 **200x200mm**  
**A.CR** CHROM **2060,00**  
**A.NO** CZARNY MAT **3465,00**

**INDEKS B** SNK300 **300x300mm**  
**B.CR** CHROM **2180,00**

**INDEKS F** SNK250 **250x250mm**  
**F.CR** CHROM **1900,00**

**EL/EF015ZN3..**

ZESTAW NATRYSKOWY PODTYNKOWY



**SKŁAD ZESTAWU:**  
 -DESZCZOWNICA:  
 ZSOF301 **500x500MM** (CHROM)  
 A579EFCM44 **440x440MM** (CZARNY MAT) -DANIEL-  
 - ZESTAW 3w1 ZDUP095



**CR** CHROM  
**NO** CZARNY MAT

**CPT518ZES01..**

ZESTAW NATRYSKOWY PODTYNKOWY **TERMOSTAT**

**6780,00**

**8350,00**

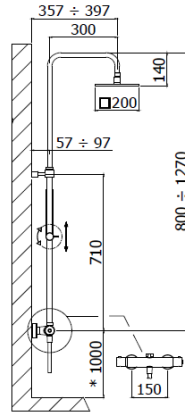
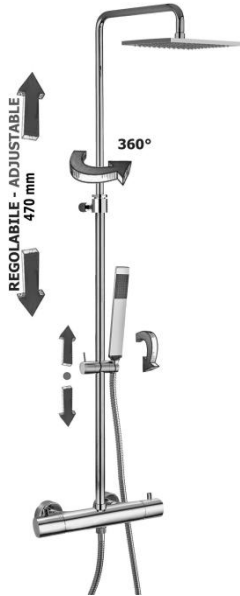

INDEKS **ZCOL641LIQ-CRX**

CR CHROM 2220,00

INDEKS **ZCOL641LIQ**

CR CHROM 2300,00  
NO CZARNY MAT 3300,00

INDEKS **ZCOL641KLIQ**

CR CHROM 2500,00  
NO CZARNY MAT 3800,00

**ZCOL641LIQ-CRX** KOLUMNA NATRYSKOWA TERMOSTAT  
**ZCOL641LIQ** KOLUMNA NATRYSKOWA TERMOSTAT  
**ZCOL641KLIQ** KOLUMNA NATRYSKOWA TERMOSTAT

**250x250MM SLIM**  
**200x200MM**  
**300x300MM**

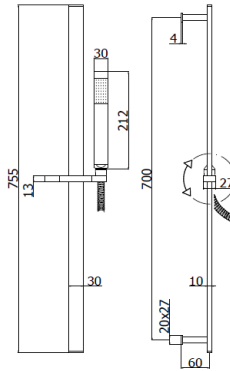

CR CHROM 650,00  
NO CZARNY MAT 850,00

**ZSAL145..** ZESTAW NATRYSKOWY METALOWY CITY

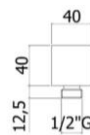

CR CHROM 190,00  
NO CZARNY MAT 310,00

**ZACC238..** PRZYŁĄCZE KĄTOWE METALOWE

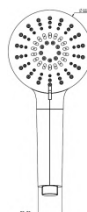

NO CZARNY MAT 85,00

**RN01** RĄCZKA NATRYSKOWA GARDA

-AP-

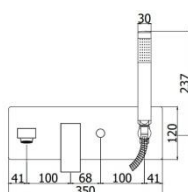
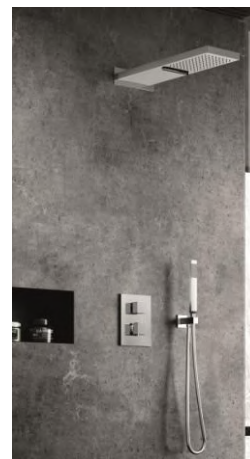

**LES001..**

BATERIA WANNOWA PODTYNKOWA ZESPOLONA

**CR**

CHROM

**2100,00**

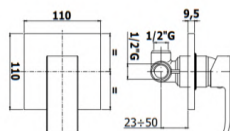

**LES010..**

BATERIA PODTYNKOWA 1-DROŻNA

**CR**

CHROM

**320,00**

**\*ST**

STAL SZCZOTKOWANA

**630,00**

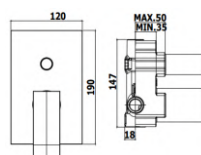

**LES015..**

BATERIA PODTYNKOWA 2-DROŻNA

**CR**

CHROM

**580,00**

**\*ST**

STAL SZCZOTKOWANA

**1200,00**

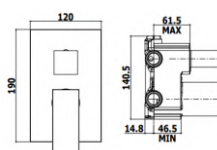

**LES018..**

BATERIA PODTYNKOWA 2-DROŻNA Z PRZEŁĄCZNIKIEM MECHANICZNYM

**CR**

CHROM

**1020,00**

**LES019..**

BATERIA PODTYNKOWA 3-DROŻNA Z PRZEŁĄCZNIKIEM MECHANICZNYM

**\*ST**

STAL SZCZOTKOWANA

**1900,00**

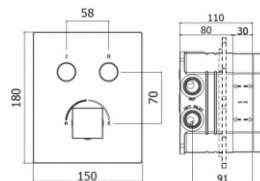

**CPM518..** BATERIA PODTYNKOWA 2-DROŻNA (CPBOX)  
**CPM519..** BATERIA PODTYNKOWA 3-DROŻNA (CPBOX)

**CR** CHROM 2600,00  
**ST** STAL SZCZOTKOWANA 3700,00

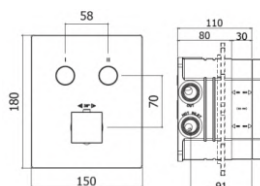

**CPT513** BATERIA PODTYNKOWA TERMOBAT 1-DROŻNA (CPBOX)  
**CPT518** BATERIA PODTYNKOWA TERMOBAT 2-DROŻNA (CPBOX)  
**CPT519** BATERIA PODTYNKOWA TERMOBAT 3-DROŻNA (CPBOX)



**CR** CHROM 2800,00  
**ST** STAL SZCZOTKOWANA 3900,00

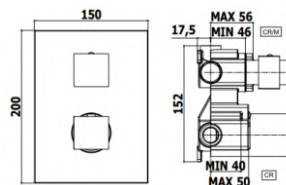

**LEQ513..** BATERIA PODTYNKOWA TERMOSTATYCZNA 1-DROŻNA  
**LEQ518..** BATERIA PODTYNKOWA TERMOSTATYCZNA 2-DROŻNA  
**LEQ519..** BATERIA PODTYNKOWA TERMOSTATYCZNA 3-DROŻNA



**CR** CHROM 1950,00  
**\*ST** STAL SZCZOTKOWANA 3200,00

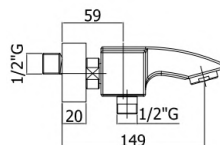

**LEC022..** BATERIA WANNOWA ŚCIENNA (KORPUS)  
**LEC023..** BATERIA WANNOWA ŚCIENNA (KOMPLETNA)



**INDEKS LEC022**  
**CR** CHROM 1020,00  
**\*ST** STAL SZCZOTKOWANA 1350,00

**INDEKS LEC023**  
**CR** CHROM 1200,00  
**\*ST** STAL SZCZOTKOWANA 1600,00





**LEC040..**

BATERIA WANNOWA 3-OTWOROWA

**LEC041..**

BATERIA WANNOWA 2-OTWOROWA (BEZ WYLEWKI)

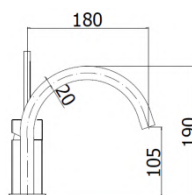

**INDEKS LEC040**

**CR** CHROM 2300,00  
**\*ST** STAL SZCZOTKOWANA 3500,00

**INDEKS LEC041**

**CR** CHROM 1500,00  
**\*ST** STAL SZCZOTKOWANA 2300,00



**LES040..**

BATERIA WANNOWA 3-OTWOROWA

**LES041..**

BATERIA WANNOWA 2-OTWOROWA (BEZ WYLEWKI)

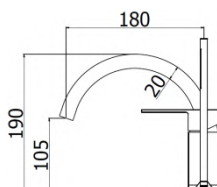

**INDEKS LES040**

**CR** CHROM 2150,00  
**\*ST** STAL SZCZOTKOWANA 3500,00

**INDEKS LES041**

**CR** CHROM 1350,00  
**\*ST** STAL SZCZOTKOWANA 2100,00



**LES061..**

BATERIA UMYWALKOWA STOJĄCA KASKADA (BEZ KORKA)

**LES061K..**

BATERIA UMYWALKOWA STOJĄCA KASKADA (KOREK CLICK CLACK)

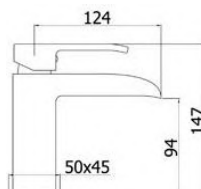

**INDEKS LES061**

**CR** CHROM 950,00  
**\*ST** STAL SZCZOTKOWANA 1600,00

**INDEKS LES061K**

**CR** CHROM 1030,00  
**\*ST** STAL SZCZOTKOWANA 1740,00



**LES071..**

BATERIA UMYWALKOWA STOJĄCA (BEZ KORKA)

**LES071K..**

BATERIA UMYWALKOWA STOJĄCA (KOREK CLICK CLACK)

**LES075..**

BATERIA UMYWALKOWA STOJĄCA (KOREK AUTOMATYCZNY)

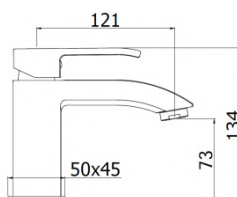

**INDEKS LES071**

**CR** CHROM 565,00  
**\*ST** STAL SZCZOTKOWANA 910,00

**INDEKS LES071K**

**CR** CHROM 645,00  
**\*ST** STAL SZCZOTKOWANA 1150,00

**INDEKS LES075**

**CR** CHROM 645,00  
**\*ST** STAL SZCZOTKOWANA 1150,00

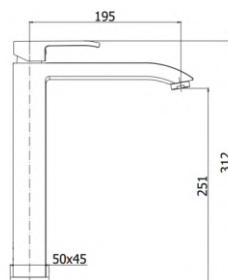

**LES081..** BATERIA UMYWALKOWA WYSOKA (BEZ KORKA)  
**LES081K..** BATERIA UMYWALKOWA WYSOKA (KOREK CLICK CLACK)

**INDEKS LES081**  
**CR** CHROM **1180,00**  
**\*ST** STAL SZCZOTKOWANA **1900,00**

**INDEKS LES081K**  
**CR** CHROM **1260,00**  
**\*ST** STAL SZCZOTKOWANA **2140,00**

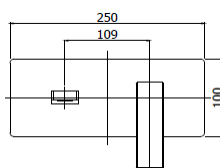

**LES104..** BATERIA UMYWALKOWA PODTYNKOWA L-150MM  
**LES105..** BATERIA UMYWALKOWA PODTYNKOWA L-200MM  
**LES106..** BATERIA UMYWALKOWA PODTYNKOWA L-240MM

**CR** CHROM **1370,00**  
**\*ST** STAL SZCZOTKOWANA **2150,00**

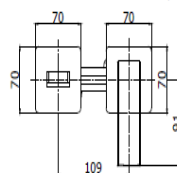

**LES104..70** BATERIA UMYWALKOWA PODTYNKOWA L-150MM  
**LES105..70** BATERIA UMYWALKOWA PODTYNKOWA L-200MM  
**LES106..70** BATERIA UMYWALKOWA PODTYNKOWA L-240MM

**CR** CHROM **1320,00**

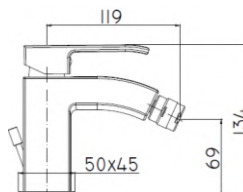

**LES131..** BATERIA BIDETOWA STOJĄCA (BEZ KORKA)  
**LES131K..** BATERIA BIDETOWA STOJĄCA (KOREK CLICK CLACK)  
**LES135..** BATERIA BIDETOWA STOJĄCA (KOREK AUTOMATYCZNY)

**INDEKS LES131**  
**CR** CHROM **565,00**  
**\*ST** STAL SZCZOTKOWANA **910,00**

**INDEKS LES131K**  
**CR** CHROM **645,00**  
**\*ST** STAL SZCZOTKOWANA **1150,00**

**INDEKS LES135**  
**CR** CHROM **645,00**  
**\*ST** STAL SZCZOTKOWANA **1150,00**



- LEC168..** BATERIA NATRYSKOWA ŚCIENNA (KORPUS)
- LEC168D..** BATERIA NATRYSKOWA ŚCIENNA (KOMPLETNA)
- LEQ268..** BATERIA NATRYSKOWA ŚCIENNA **TERMOSTAT** (KORPUS)

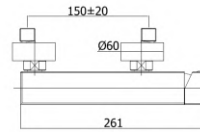

	<b>INDEKS LEC168</b>	
<b>CR</b>	CHROM	<b>750,00</b>
<b>*ST</b>	STAL SZCZOTKOWANA	<b>1250,00</b>

	<b>INDEKS LEC168D</b>	
<b>CR</b>	CHROM	<b>950,00</b>
<b>*ST</b>	STAL SZCZOTKOWANA	<b>1550,00</b>

	<b>INDEKS LEQ268</b>	
<b>CR</b>	CHROM	<b>1600,00</b>
<b>*ST</b>	STAL SZCZOTKOWANA	<b>2500,00</b>



**LEA176..** BATERIA ZLEWOZMYWAKOWA STOJĄCA Z WĘŻEM OPERACYJNYM

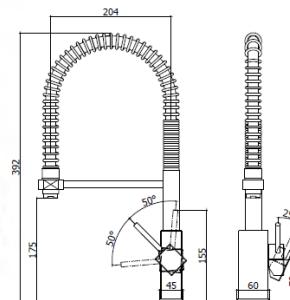

<b>CR</b>	CHROM	<b>1250,00</b>
<b>*ST</b>	STAL SZCZOTKOWANA	<b>2050,00</b>



**LEA838..** BATERIA STOJĄCA NISKA (BEZ KORKA)  
**LEA838K..** BATERIA STOJĄCA NISKA (KOREK CLICK CLACK)

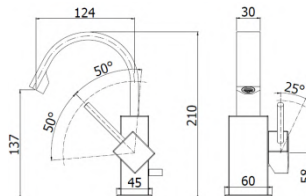

	<b>INDEKS LEA838</b>	
<b>CR</b>	CHROM	<b>1230,00</b>
<b>*ST</b>	STAL SZCZOTKOWANA	<b>2100,00</b>

	<b>INDEKS LEA838K</b>	
<b>CR</b>	CHROM	<b>1310,00</b>
<b>*ST</b>	STAL SZCZOTKOWANA	<b>2340,00</b>



**LEA878..** BATERIA STOJĄCA WYSOKA (BEZ KORKA)  
**LEA878K..** BATERIA STOJĄCA WYSOKA (KOREK CLICK CLACK)

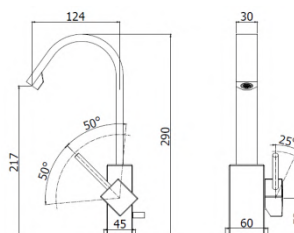

	<b>INDEKS LEA878</b>	
<b>CR</b>	CHROM	<b>1280,00</b>
<b>*ST</b>	STAL SZCZOTKOWANA	<b>2100,00</b>

	<b>INDEKS LEA878K</b>	
<b>CR</b>	CHROM	<b>1360,00</b>
<b>*ST</b>	STAL SZCZOTKOWANA	<b>2340,00</b>

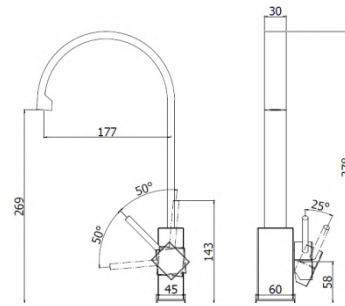

**LEA880..** BATERIA ZLEWOZMYWAKOWA STOJĄCA

**CR** CHROM 1450,00  
**\*ST** STAL SZCZOTKOWANA 2400,00

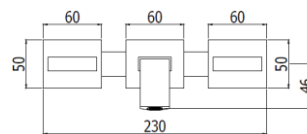

**LEP003..** BATERIA UMYWALKOWA PODTYNKOWA (BEZ KORKA)  
**LEP003K..** BATERIA UMYWALKOWA PODTYNKOWA (KOREK CLICK CLACK)

**CR** CHROM 1650,00  
**INDEKS LEP003**

**CR** CHROM 1730,00  
**INDEKS LEP003K**

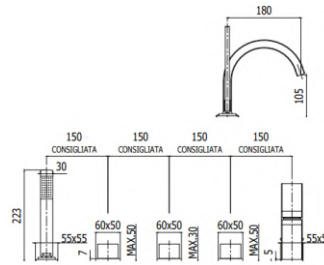

**LEP044..** BATERIA WANNOWA 5-OTWOROWA

**CR** CHROM 3000,00

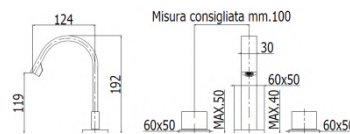

**LEP052..** BATERIA 3-OTWOROWA WYSOKA (BEZ KORKA)  
**LEP052K..** BATERIA 3-OTWOROWA WYSOKA (KOREK CLICK CLACK)

**CR** CHROM 1700,00  
**INDEKS LEP052**

**CR** CHROM 1780,00  
**INDEKS LEP052K**

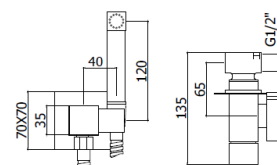

**22685..** BATERIA BIDETOWA PODTYNKOWA VIOLA (KOMPLETNA)

**CR** CHROM 600,00



**SKŁAD ZESTAWU:**  
 - ZESTAW 3W1 ZDUP095  
 - WYLEWKA ŚCIENNA SK4704 -DANIEL-



<b>CR</b>	CHROM	<b>1595,00</b>
<b>*ST</b>	STAL SZCZOTKOWANA	<b>3050,00</b>

**LES015ZWW..** ZESTAW WANNOWY PODTYNKOWY (WYLEWKA L-170MM)



**SKŁAD ZESTAWU:**  
 - ZESTAW 3W1 ZDUP095  
 - SYFON WANNOWY Z NAPEŁNIENIEM D6 -CRS-



<b>CR</b>	CHROM	<b>1455,00</b>
<b>*ST</b>	STAL SZCZOTKOWANA	<b>2930,00</b>

**LES015ZWS..** ZESTAW WANNOWY PODTYNKOWY Z NAPEŁNIENIEM PRZEZ PRZELEW



**SKŁAD ZESTAWU:**  
 - DESZCZOWNICA:  
 (INDEKS A) ZSOF075 **200x200mm**  
 (INDEKS B) SNK300 **300x300mm, SLIM -AP-**  
 - RAMIĘ ŚCIENNE L-400MM  
 - ZESTAW 3W1 ZDUP095  
 - WYLEWKA ŚCIENNA SK4704 -DANIEL-



	<b>INDEKS A</b>	<b>ZSOF075</b>	<b>200x200mm</b>
<b>A.CR</b>	CHROM		<b>2935,00</b>
<b>A.ST</b>	STAL SZCZOTKOWANA		<b>5010,00</b>

	<b>INDEKS B</b>	<b>SNK300</b>	<b>300x300mm</b>
<b>B.CR</b>	CHROM		<b>2855,00</b>

**LES019ZSCW3..** ZESTAW WANNOWY PODTYNKOWY (WYLEWKA L-170MM)



- SKŁAD ZESTAWU:**  
 - DESZCZOWNICA:  
 (INDEKS A) ZSOF075 200x200MM  
 (INDEKS B) SNK300 300x300MM, SLIM -AP-  
 - RAMIĘ ŚCIENNE L-400MM  
 - ZESTAW 3w1 ZDUP095  
 - SYFON WANNOWY Z NAPEŁNIENIEM -CRS-



INDEKS A ZSOF075 200x200mm  
**A.CR** CHROM 2795,00  
**A.ST** STAL SZCZOTKOWANA 5000,00

INDEKS B SNK300 300x300mm  
**B.CR** CHROM 2715,00

**LES019ZWSCSU3..** ZESTAW WANNOWY PODTYNKOWY Z NAPEŁNIENIEM PRZEZ PRZELEW



- SKŁAD ZESTAWU:**  
 - DESZCZOWNICA:  
 (INDEKS A) ZSOF075 200x200MM  
 (INDEKS B) SNK300 300x300MM, SLIM -AP-  
 (INDEKS F) SNK250 25x25cm, SLIM -AP-  
 - RAMIĘ ŚCIENNE L-400MM  
 - ZESTAW 3w1 ZDUP095



INDEKS A ZSOF075 200x200mm  
**A.CR** CHROM 1815,00  
**A.ST** STAL SZCZOTKOWANA 3740,00

INDEKS B SNK300 300x300mm  
**B.CR** CHROM 1735,00

(indeks F) SNK250 250x250mm  
**F.CR** CHROM 1655,00

**LES015ZSC3..** ZESTAW NATRYSKOWY PODTYNKOWY



- SKŁAD ZESTAWU:**  
 - DESZCZOWNICA:  
 (INDEKS A) ZSOF075 200x200MM  
 (INDEKS B) SNK300 300x300MM, SLIM -AP-  
 (INDEKS F) SNK250 25x25cm, SLIM -AP-  
 - RAMIĘ ŚCIENNE L-400MM  
 - ZESTAW 3w1 ZDUP095



INDEKS A ZSOF075 200x200mm  
**A.CR** CHROM 3800,00  
**A.ST** STAL SZCZOTKOWANA 5810,00

INDEKS B SNK300 300x300mm  
**B.CR** CHROM 3720,00

INDEKS E C06658 300x300mm  
**E.CR** CHROM 4120,00

(indeks F) SNK250 250x250mm  
**F.CR** CHROM 3635,00

**CPM518ZSC3..** ZESTAW NATRYSKOWY PODTYNKOWY



**SKŁAD ZESTAWU:**  
 - DESZCZOWNICA:  
 (INDEKS A) ZSOF075 200x200MM  
 (INDEKS B) SNK300 300x300MM, SLIM -AP-  
 (INDEKS F) SNK250 25x25cm, SLIM -AP  
 - RAMIĘ ŚCIENNE L-400MM  
 - ZESTAW 3w1 ZDUP095



**INDEKS A** ZSOF075 200x200mm  
**A.CR** CHROM 3995,00  
**A.ST** STAL SZCZOTKOWANA 6010,00

**INDEKS B** SNK300 300x300mm  
**B.CR** CHROM 3915,00

**(indeks F)** SNK250 250x250mm  
**F.CR** CHROM 3835,00

**CPT518ZSC3..** ZESTAW NATRYSKOWY PODTYNKOWY **TERMOSTAT**



**SKŁAD ZESTAWU:**  
 - DESZCZOWNICA:  
 ZSOF301 50x50cm (CHROM)  
 - ZESTAW 3w1 ZDUP095



**CR** CHROM 5100,00

**LES018ZES01..** ZESTAW NATRYSKOWY PODTYNKOWY



**SKŁAD ZESTAWU:**  
 - DESZCZOWNICA:  
 (INDEKS A) ZSOF075 200x200MM  
 (INDEKS B) SNK300 300x300MM, SLIM -AP-  
 (INDEKS F) SNK250 25x25cm, SLIM -AP  
 - RAMIĘ ŚCIENNE L-400MM  
 - PODŁĄCZENIE PODTYNKOWE ZACC238CR  
 - ZESTAW NATRYSKOWY ZSALO79



**INDEKS A** ZSOF075 200x200mm  
**A.CR** CHROM 2100,00  
**A.ST** STAL SZCZOTKOWANA 4200,00

**INDEKS B** SNK300 300x300mm  
**B.CR** CHROM 2020,00

**(indeks F)** SNK250 250x250mm  
**F.CR** CHROM 1940,00

**LES015ZN3..** ZESTAW NATRYSKOWY PODTYNKOWY



**SKŁAD ZESTAWU:**

- DESZCZOWNICA:

(INDEKS A) ZSOF075

(INDEKS B) SNK300

(INDEKS F) SNK250

- RAMIĘ ŚCIENNE L-400MM

- ZESTAW 3w1 ZDUP095

200x200MM

300x300MM, SLIM -AP-

25x25CM, SLIM -AP



INDEKS A ZSOF075 200x200mm

A.CR CHROM 4095,00

A.ST STAL SZCZOTKOWANA 4600,00

INDEKS B SNK300 300x300mm

B.CR CHROM 4015,00

(indeks F) SNK250 250x250mm

F.CR CHROM 1940,00

**LEQ518ZSC3..** ZESTAW NATRYSKOWY PODTYNKOWY **TERMOSTAT**

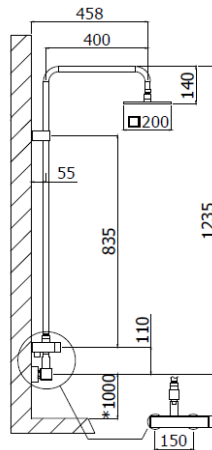

**ZCOL607..**

KOLUMNA NATRYSKOWA

LEVEL PLUS



CR

CHROM

3000,00

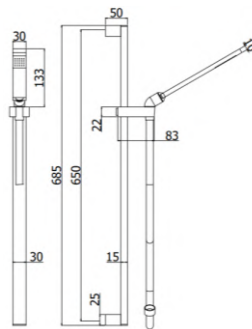

**ZSAL079..**

ZESTAW NATRYSKOWY

LEVEL



CR

CHROM

440,00



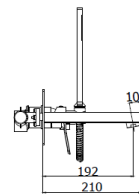

**T1001..** BATERIA WANNOWA PODTYNKOWA ZESPOLONA

<b>CR</b>	CHROM	<b>2100,00</b>
<b>NO</b>	CZARNY MAT	<b>2700,00</b>
<b>*BO</b>	BIAŁY MAT	<b>2700,00</b>
<b>ST</b>	STAL SZCZOTKOWANA	<b>3100,00</b>

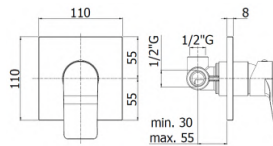

**T1010..** BATERIA PODTYNKOWA 1-DROŻNA

<b>CR</b>	CHROM	<b>290,00</b>
<b>NO</b>	CZARNY MAT	<b>500,00</b>
<b>*BO</b>	BIAŁY MAT	<b>500,00</b>
<b>*ST</b>	STAL SZCZOTKOWANA	<b>560,00</b>

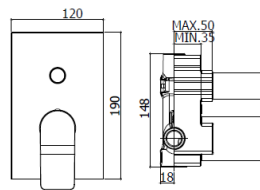

**T1015..** BATERIA PODTYNKOWA 2-DROŻNA

<b>CR</b>	CHROM	<b>550,00</b>
<b>NO</b>	CZARNY MAT	<b>1000,00</b>
<b>*BO</b>	BIAŁY MAT	<b>1000,00</b>
<b>ST</b>	STAL SZCZOTKOWANA	<b>1100,00</b>

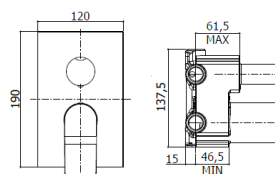

**T1018..** BATERIA PODTYNKOWA 2-DROŻNA Z PRZEŁĄCZNIKIEM MECHANICZNYM

**T1019..** BATERIA PODTYNKOWA 3-DROŻNA Z PRZEŁĄCZNIKIEM MECHANICZNYM

<b>CR</b>	CHROM	<b>1000,00</b>
<b>NO</b>	CZARNY MAT	<b>1600,00</b>
<b>*BO</b>	BIAŁY MAT	<b>1600,00</b>
<b>ST</b>	STAL SZCZOTKOWANA	<b>1800,00</b>



**CPM518 ..** BATERIA PODTYNKOWA 2-DROŻNA (CPBOX)  
**CPM519 ..** BATERIA PODTYNKOWA 3-DROŻNA (CPBOX)

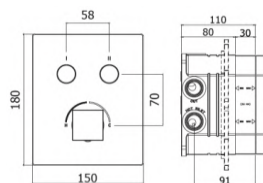

<b>CR</b>	CHROM	<b>2600,00</b>
<b>NO</b>	CZARNY MAT	<b>3200,00</b>
<b>*BO</b>	BIAŁY MAT	<b>3200,00</b>
<b>ST</b>	STAL SZCZOTKOWANA	<b>3700,00</b>



**TI022..** BATERIA WANNOWA ŚCIENNA (KORPUS)  
**TI023..** BATERIA WANNOWA ŚCIENNA (KOMPLETNA)

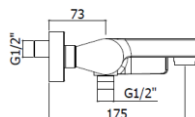

**INDEKS TI022**

<b>CR</b>	CHROM	<b>1000,00</b>
<b>NO</b>	CZARNY MAT	<b>1350,00</b>
<b>*BO</b>	BIAŁY MAT	<b>1350,00</b>
<b>ST</b>	STAL SZCZOTKOWANA	<b>1510,00</b>

**INDEKS TI023**

<b>CR</b>	CHROM	<b>1200,00</b>
<b>NO</b>	CZARNY MAT	<b>1500,00</b>
<b>*BO</b>	BIAŁY MAT	<b>1500,00</b>
<b>ST</b>	STAL SZCZOTKOWANA	<b>1800,00</b>



**TI040..** BATERIA WANNOWA 3-OTWOROWA

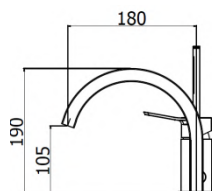

<b>CR</b>	CHROM	<b>2000,00</b>
<b>NO</b>	CZARNY MAT	<b>2650,00</b>
<b>*BO</b>	BIAŁY MAT	<b>2650,00</b>
<b>ST</b>	STAL SZCZOTKOWANA	<b>3000,00</b>



**TI071..** BATERIA UMYWALKOWA STOJĄCA (BEZ KORKA)  
**TI071K..** BATERIA UMYWALKOWA STOJĄCA (KOREK CLICK CLACK)

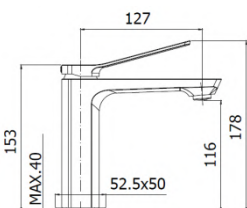

**INDEKS TI071**

<b>CR</b>	CHROM	<b>565,00</b>
<b>NO</b>	CZARNY MAT	<b>720,00</b>
<b>*BO</b>	BIAŁY MAT	<b>720,00</b>
<b>ST</b>	STAL SZCZOTKOWANA	<b>850,00</b>

**INDEKS TI071K**

<b>CR</b>	CHROM	<b>645,00</b>
<b>NO</b>	CZARNY MAT	<b>840,00</b>
<b>*BO</b>	BIAŁY MAT	<b>840,00</b>
<b>ST</b>	STAL SZCZOTKOWANA	<b>1090,00</b>

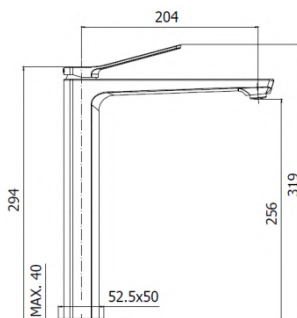

**T1081..** BATERIA UMYWALKOWA WYSOKA (BEZ KORKA)  
**T1081K..** BATERIA UMYWALKOWA WYSOKA (KOREK CLICK CLACK)

<b>INDEKS T1081</b>		
<b>CR</b>	CHROM	<b>900,00</b>
<b>NO</b>	CZARNY MAT	<b>1200,00</b>
<b>*BO</b>	BIAŁY MAT	<b>1200,00</b>
<b>ST</b>	STAL SZCZOTKOWANA	<b>1400,00</b>

<b>INDEKS T1081K</b>		
<b>CR</b>	CHROM	<b>980,00</b>
<b>NO</b>	CZARNY MAT	<b>1320,00</b>
<b>*BO</b>	BIAŁY MAT	<b>1320,00</b>
<b>ST</b>	STAL SZCZOTKOWANA	<b>1640,00</b>

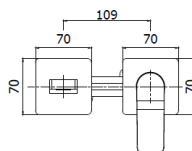
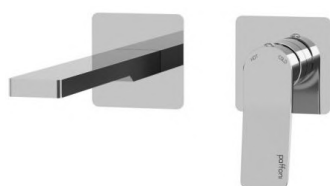

**T1104..70** BATERIA UMYWALKOWA PODTYNKOWA L-150MM  
**T1105..70** BATERIA UMYWALKOWA PODTYNKOWA L-200MM  
**T1106..70** BATERIA UMYWALKOWA PODTYNKOWA L-240MM

<b>CR</b>	CHROM	<b>1350,00</b>
<b>NO</b>	CZARNY MAT	<b>1700,00</b>
<b>*BO</b>	BIAŁY MAT	<b>1700,00</b>
<b>*ST</b>	STAL SZCZOTKOWANA	<b>2100,00</b>

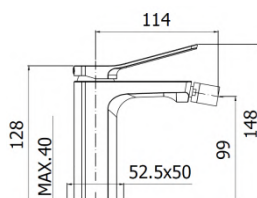

**T1131..** BATERIA BIDETOWA STOJĄCA (BEZ KORKA)  
**T1131K..** BATERIA BIDETOWA STOJĄCA (KOREK CLICK CLACK)

<b>INDEKS T1131</b>		
<b>CR</b>	CHROM	<b>565,00</b>
<b>NO</b>	CZARNY MAT	<b>720,00</b>
<b>*BO</b>	BIAŁY MAT	<b>720,00</b>
<b>ST</b>	STAL SZCZOTKOWANA	<b>850,00</b>

<b>INDEKS T1131K</b>		
<b>CR</b>	CHROM	<b>645,00</b>
<b>NO</b>	CZARNY MAT	<b>840,00</b>
<b>*BO</b>	BIAŁY MAT	<b>840,00</b>
<b>ST</b>	STAL SZCZOTKOWANA	<b>1090,00</b>

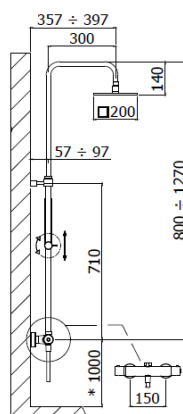
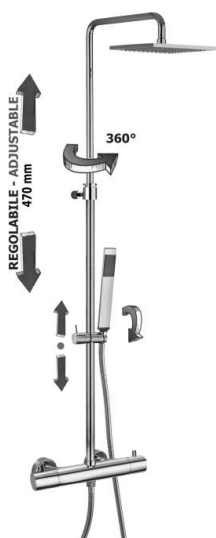

**ZCOL641LIQ** KOLUMNA NATRYSKOWA TERMOSTAT



<b>CR</b>	CHROM	<b>2300,00</b>
<b>NO</b>	CZARNY MAT	<b>3300,00</b>



**SKŁAD ZESTAWU:**  
 - ZESTAW 3w1 ZDUP095  
 - WYLEWKA L-17cm SK4704 -DANIEL-

**TI015ZWW..** ZESTAW WANNOWY PODTYNKOWY Z WYLEWKĄ



<b>CR</b>	CHROM	<b>1525,00</b>
<b>NO</b>	CZARNY MAT	<b>2650,00</b>
<b>*BO</b>	BIAŁY MAT	<b>2650,00</b>
<b>ST</b>	STAL SZCZOTKOWANA	<b>2950,00</b>



**SKŁAD ZESTAWU:**  
 - DESZCZOWNICA:  
 (INDEKS A) ZSOF075 20x20cm  
 (INDEKS B) SNK300 30x30cm, SLIM -AP-  
 (INDEKS E) C06658 30x30cm -EMMEVI-  
 - RAMIĘ ŚCIENNE L-400MM  
 - ZESTAW 3w1 ZDUP095  
 - WYLEWKA L-17cm SK4704 -DANIEL-

**TI019ZSCW3..** ZESTAW WANNOWY PODTYNKOWY Z WYLEWKĄ



	<b>INDEKS A</b> ZSOF075 200x200mm	
<b>CR</b>	CHROM	<b>2815,00</b>
<b>NO</b>	CZARNY MAT	<b>4505,00</b>
<b>*BO</b>	BIAŁY MAT	<b>4505,00</b>
<b>ST</b>	STAL SZCZOTKOWANA	<b>4910,00</b>
	<b>INDEKS B</b> SNK300 300x300mm	
<b>CR</b>	CHROM	<b>2785,00</b>
	<b>INDEKS E</b> C06658 300x300mm	
<b>CR</b>	CHROM	<b>3185,00</b>
<b>NO</b>	CZARNY MAT	<b>5205,00</b>
<b>ST</b>	STAL SZCZOTKOWANA	<b>5610,00</b>



**SKŁAD ZESTAWU:**  
 - DESZCZOWNICA:  
 (INDEKS A) ZSOF075 20x20cm  
 (INDEKS B) SNK300 30x30cm, SLIM -AP-  
 (INDEKS E) C06658 30x30cm -EMMEVI-  
 - RAMIĘ ŚCIENNE L-400MM  
 - ZESTAW 3w1 ZDUP095

**TI015ZSC3..** ZESTAW NATRYSKOWY PODTYNKOWY



	<b>INDEKS A</b> ZSOF075 200x200mm	
<b>CR</b>	CHROM	<b>1745,00</b>
<b>NO</b>	CZARNY MAT	<b>2915,00</b>
<b>*BO</b>	BIAŁY MAT	<b>2915,00</b>
<b>ST</b>	STAL SZCZOTKOWANA	<b>3360,00</b>
	<b>INDEKS B</b> SNK300 300x300mm	
<b>CR</b>	CHROM	<b>1665,00</b>
	<b>INDEKS E</b> C06658 300x300mm	
<b>CR</b>	CHROM	<b>2065,00</b>
<b>NO</b>	CZARNY MAT	<b>3715,00</b>
<b>ST</b>	STAL SZCZOTKOWANA	<b>4130,00</b>



**SKŁAD ZESTAWU:**  
 - DESZCZOWNICA:  
 (INDEKS A) ZSOF075 20x20cm  
 (INDEKS B) SNK300 30x30cm, SLIM -AP-  
 (INDEKS E) C06658 30x30cm -EMMEVI-  
 - RAMIĘ ŚCIENNE L-400MM  
 - ZESTAW 3w1 ZDUP095



INDEKS A ZSOF075 200x200mm		
CR	CHROM	3800,00
NO	CZARNY MAT	4715,00
*BO	BIAŁY MAT	4715,00
ST	STAL SZCZOTKOWANA	5810,00

INDEKS B SNK300 300x300mm		
CR	CHROM	3720,00

INDEKS E C06658 300x300mm		
CR	CHROM	4120,00
NO	CZARNY MAT	5905,00
ST	STAL SZCZOTKOWANA	6510,00

**CPM518ZSC3..** ZESTAW NATRYSKOWY PODTYNKOWY

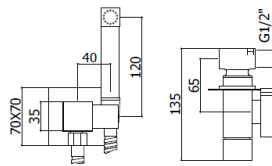

CR	CHROM	600,00
NO	CZARNY MAT	800,00

**ZDUP112..** BATERIA BIDETOWA PODTYNKOWA VIOLA

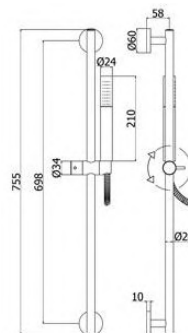

CR	CHROM	560,00
*BO	BIAŁY MAT	750,00
NO	CZARNY MAT	750,00
ST	STAL SZCZOTKOWANA	950,00

**ZSAL135..** ZESTAW NATRYSKOWY LIFE

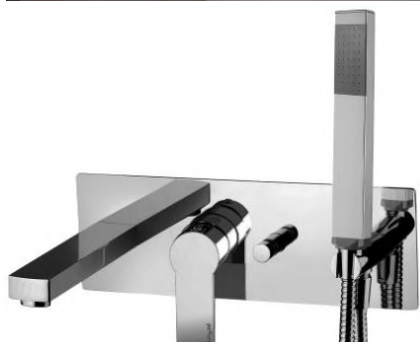

**TA001..** BATERIA WANNOWA PODTYNKOWA ZESPOLONA

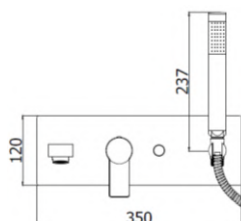

<b>CR</b>	CHROM	<b>2100,00</b>
<b>*ST</b>	STAL SZCZOTKOWANA	<b>3100,00</b>
<b>NO</b>	CZARNY MAT	<b>2750,00</b>



**TA010..** BATERIA PODTYNKOWA 1-DROŻNA

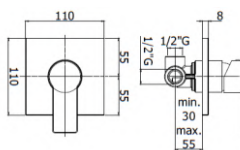

<b>CR</b>	CHROM	<b>290,00</b>
<b>*ST</b>	STAL SZCZOTKOWANA	<b>560,00</b>
<b>NO</b>	CZARNY MAT	<b>500,00</b>



**TA015..** BATERIA PODTYNKOWA 2-DROŻNA

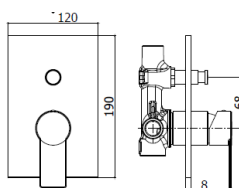

<b>CR</b>	CHROM	<b>550,00</b>
<b>*ST</b>	STAL SZCZOTKOWANA	<b>1100,00</b>
<b>NO</b>	CZARNY MAT	<b>980,00</b>



**TA018..** BATERIA PODTYNKOWA 2-DROŻNA Z PRZEŁĄCZNIKIEM MECHANICZNYM

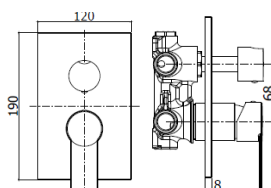

<b>CR</b>	CHROM	<b>1000,00</b>
<b>*ST</b>	STAL SZCZOTKOWANA	<b>1800,00</b>

**TA019..** BATERIA PODTYNKOWA 3-DROŻNA Z PRZEŁĄCZNIKIEM MECHANICZNYM

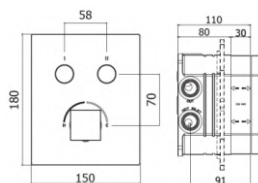

**CPM518..** BATERIA PODTYNKOWA 2-DROŻNA (KOMPLETNA Z CPBOX)  
**CPM519..** BATERIA PODTYNKOWA 3-DROŻNA (KOMPLETNA Z CPBOX)

<b>CR</b>	CHROM	<b>2600,00</b>
<b>*ST</b>	STAL SZCZOTKOWANA	<b>3700,00</b>
<b>NO</b>	CZARNY MAT	<b>3200,00</b>



**TA022..** BATERIA WANNOWA ŚCIENNA (KORPUS)  
**TA023..** BATERIA WANNOWA ŚCIENNA (KOMPLETNA)

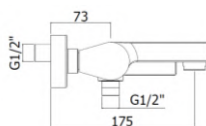

**INDEKS TA022**

<b>CR</b>	CHROM	<b>1060,00</b>
<b>*ST</b>	STAL SZCZOTKOWANA	<b>1500,00</b>
<b>NO</b>	CZARNY MAT	<b>1300,00</b>

**INDEKS TA023**

<b>CR</b>	CHROM	<b>1280,00</b>
<b>*ST</b>	STAL SZCZOTKOWANA	<b>1800,00</b>
<b>NO</b>	CZARNY MAT	<b>1550,00</b>



**TA040..** BATERIA WANNOWA 3-OTWOROWA  
**TA041..** BATERIA WANNOWA 2-OTWOROWA (BEZ WYLEWKI)

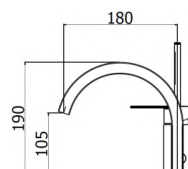

**INDEKS TA040**

<b>CR</b>	CHROM	<b>2000,00</b>
<b>*ST</b>	STAL SZCZOTKOWANA	<b>3150,00</b>
<b>NO</b>	CZARNY MAT	<b>2700,00</b>

**INDEKS TA041**

<b>CR</b>	CHROM	<b>1150,00</b>
<b>*ST</b>	STAL SZCZOTKOWANA	<b>1900,00</b>
<b>NO</b>	CZARNY MAT	<b>2200,00</b>



**TA071..** BATERIA UMYWALKOWA STOJĄCA (BEZ KORKA)  
**TA071K..** BATERIA UMYWALKOWA STOJĄCA (KOREK CLICK CLACK)

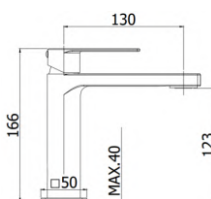

**INDEKS TA071**

<b>CR</b>	CHROM	<b>520,00</b>
<b>*ST</b>	STAL SZCZOTKOWANA	<b>860,00</b>
<b>NO</b>	CZARNY MAT	<b>680,00</b>

**INDEKS TA071K**

<b>CR</b>	CHROM	<b>600,00</b>
<b>*ST</b>	STAL SZCZOTKOWANA	<b>1020,00</b>
<b>NO</b>	CZARNY MAT	<b>800,00</b>

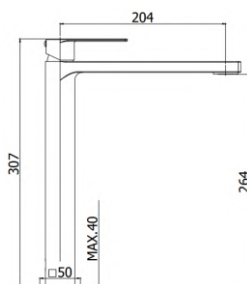

**TA081..** BATERIA UMYWALKOWA WYSOKA (BEZ KORKA)  
**TA081K..** BATERIA UMYWALKOWA WYSOKA (KOREK CLICK CLACK)

INDEKS TA081		
CR	CHROM	860,00
*ST	STAL SZCZOTKOWANA	1280,00
NO	CZARNY MAT	1150,00

INDEKS TA081K		
CR	CHROM	940,00
*ST	STAL SZCZOTKOWANA	1520,00
NO	CZARNY MAT	1270,00

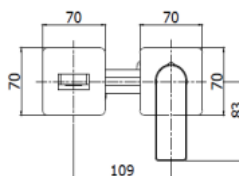

**TA104..70** BATERIA UMYWALKOWA PODTYNKOWA L-150MM  
**TA105..70** BATERIA UMYWALKOWA PODTYNKOWA L-200MM  
**TA106..70** BATERIA UMYWALKOWA PODTYNKOWA L-240MM

CR	CHROM	1300,00
*ST	STAL SZCZOTKOWANA	2300,00
NO	CZARNY MAT	1900,00

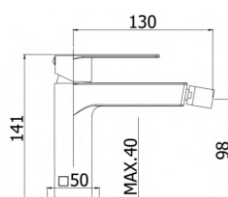

**TA131..** BATERIA BIDETOWA STOJĄCA (BEZ KORKA)  
**TA131K..** BATERIA BIDETOWA STOJĄCA (KOREK CLICK CLACK)

INDEKS TA131		
CR	CHROM	520,00
*ST	STAL SZCZOTKOWANA	860,00
NO	CZARNY MAT	680,00

INDEKS TA131K		
CR	CHROM	600,00
*ST	STAL SZCZOTKOWANA	1020,00
NO	CZARNY MAT	800,00

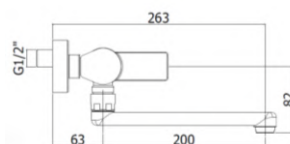

**TA161..** BATERIA UMYWALKOWA ŚCIENNA

CR	CHROM	750,00
*ST	STAL SZCZOTKOWANA	1200,00





**TA168..** BATERIA NATRYSKOWA ŚCIENNA (KORPUS)  
**TA168D..** BATERIA NATRYSKOWA ŚCIENNA (KOMPLETNA)

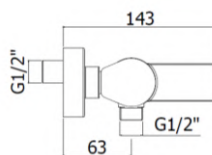

INDEKS TA168		
CR	CHROM	690,00
*ST	STAL SZCZOTKOWANA	1050,00
*NO	CZARNY MAT	850,00

INDEKS TA168D		
CR	CHROM	860,00
*ST	STAL SZCZOTKOWANA	1300,00
*NO	CZARNY MAT	1100,00



**TA018ZWW..** ZESTAW WANNOWY PODTYNKOWY Z WYLEWKĄ

SKŁAD ZESTAWU:  
 - ZESTAW 3w1 ZDUP095  
 - WYLEWKA L-17cm SK4704 -DANIEL-

CR	CHROM	1985,00
*ST	STAL SZCZOTKOWANA	3750,00



**TA018ZWS..** ZESTAW WANNOWY PODTYNKOWY Z WYLEWKĄ

SKŁAD ZESTAWU:  
 - ZESTAW 3w1 ZDUP095  
 - WYLEWKA L-17cm SK4704 -DANIEL-

CR	CHROM	1845,00
*ST	STAL SZCZOTKOWANA	3550,00



**TA019ZSCW3..** ZESTAW WANNOWY PODTYNKOWY Z WYLEWKĄ

SKŁAD ZESTAWU:  
 - DESZCZOWNICA:  
 (INDEKS A) ZSOF075 20x20cm  
 (INDEKS B) SNK300 30x30cm, SLIM -AP-  
 (INDEKS E) C06658 30x30cm -EMMEVI-  
 - RAMIĘ ŚCIENNE L-400mm  
 - ZESTAW 3w1 ZDUP095  
 - WYLEWKA L-17cm SK4704 -DANIEL-



INDEKS A ZSOF075 200x200mm		
CR	CHROM	2825,00
*ST	STAL SZCZOTKOWANA	5000,00

INDEKS B SNK300 300x300mm		
CR	CHROM	2745,00

INDEKS E C06658 300x300mm		
CR	CHROM	3095,00
*ST	STAL SZCZOTKOWANA	5700,00



**SKŁAD ZESTAWU:**  
 - DESZCZOWNICA:  
 (INDEKS A) ZSOF075 20x20cm  
 (INDEKS B) SNK300 30x30cm, SLIM -AP-  
 (INDEKS E) ZSOF078 30x30cm  
 - RAMIĘ ŚCIENNE L-400MM  
 - ZESTAW 3W1 ZDUP095

**TA015ZSC3..** ZESTAW NATRYSKOWY PODTYNKOWY



**INDEKS A ZSOF075 200x200mm**  
**CR** CHROM 1745,00  
**\*ST** STAL SZCZOTKOWANA 3400,00  
**NO** CZARNY MAT 2915,00

**INDEKS B SNK300 300x300mm**  
**CR** CHROM 1665,00

**INDEKS E C06658 300x300mm**  
**CR** CHROM 2065,00  
**\*ST** STAL SZCZOTKOWANA 4130,00  
**NO** CZARNY MAT 3715,00



**SKŁAD ZESTAWU:**  
 - DESZCZOWNICA:  
 (INDEKS A) ZSOF075 20x20cm  
 (INDEKS B) SNK300 30x30cm, SLIM -AP-  
 (INDEKS E) ZSOF078 30x30cm  
 - RAMIĘ ŚCIENNE L-400MM  
 - ZESTAW 3W1 ZDUP095

**CPM518ZSC3..** ZESTAW NATRYSKOWY PODTYNKOWY



**INDEKS A ZSOF075 200x200mm**  
**CR** CHROM 3800,00  
**ST** STAL SZCZOTKOWANA 5810,00  
**NO** CZARNY MAT 4715,00

**INDEKS B SNK300 300x300mm**  
**CR** CHROM 3720,00

**INDEKS E C06658 300x300mm**  
**CR** CHROM 4120,00  
**ST** STAL SZCZOTKOWANA 6510,00  
**NO** CZARNY MAT 5905,00

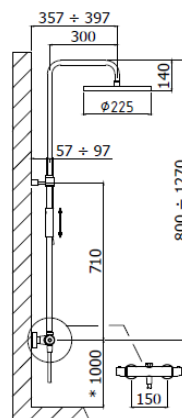
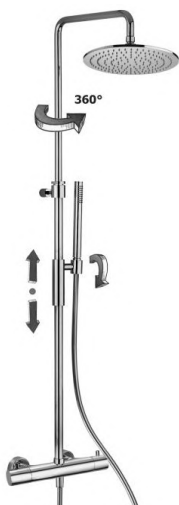

**ZCOL646..** KOLUMNA NATRYSKOWA TERMOSTATYCZNA  $\phi 225$ MM  
**ZCOL646K..** KOLUMNA NATRYSKOWA TERMOSTATYCZNA  $\phi 300$ MM



**INDEKS ZCOL646**  
**CR** CHROM 2200,00  
**ST** STAL SZCZOTKOWANA 4400,00

**INDEKS ZCOL646K**  
**CR** CHROM 2500,00  
**ST** STAL SZCZOTKOWANA 5100,00

**INDEKS ZCOL646X**  
**CR** CHROM 2100,00

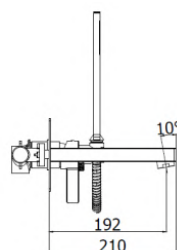
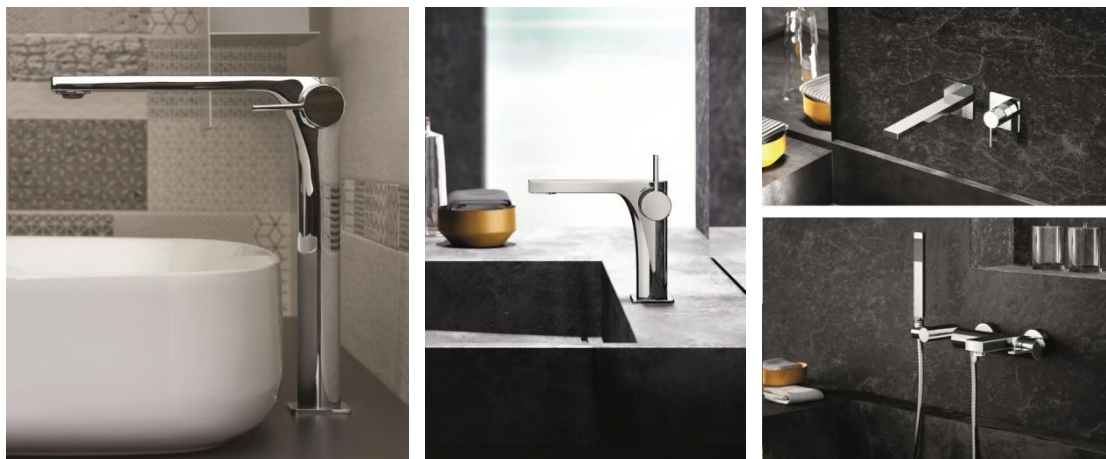

**RO001..** BATERIA WANNOWA PODTYNKOWA ZESPOLONA

**CR** CHROM 2100,00  
**\*ST** STAL SZCZOTKOWANA 3100,00

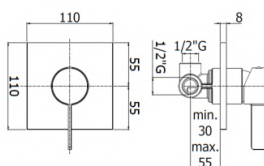

**RO010..** BATERIA PODTYNKOWA 1-DROŻNA

**CR** CHROM 290,00  
**\*ST** STAL SZCZOTKOWANA 560,00

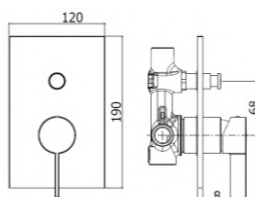

**RO015..** BATERIA PODTYNKOWA 2-DROŻNA

**CR** CHROM 550,00  
**\*ST** STAL SZCZOTKOWANA 1100,00

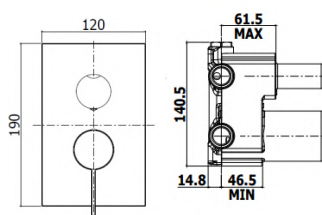

**RO018..** BATERIA PODTYNKOWA 2-DROŻNA Z PRZEŁĄCZNIKIEM MECHANICZNYM

**RO019..** BATERIA PODTYNKOWA 3-DROŻNA Z PRZEŁĄCZNIKIEM MECHANICZNYM

**CR** CHROM 1000,00  
**\*ST** STAL SZCZOTKOWANA 1800,00



**RO022..** BATERIA WANNOWA ŚCIENNA (KORPUS)  
**RO023..** BATERIA WANNOWA ŚCIENNA (KOMPLETNA)

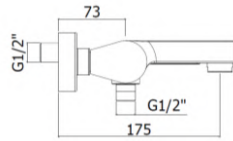

**INDEKS RO022**  
**CR** CHROM 1060,00  
**\*ST** STAL SZCZOTKOWANA 1500,00

**INDEKS RO023**  
**CR** CHROM 1280,00  
**\*ST** STAL SZCZOTKOWANA 1800,00



**RO040..** BATERIA WANNOWA 3-OTWOROWA  
**RO041..** BATERIA WANNOWA 2-OTWOROWA (BEZ WYLEWKI)

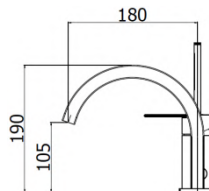

**INDEKS RO040**  
**CR** CHROM 2000,00  
**\*ST** STAL SZCZOTKOWANA 3150,00

**INDEKS RO041**  
**CR** CHROM 1150,00  
**\*ST** STAL SZCZOTKOWANA 1900,00



**RO071..** BATERIA UMYWALKOWA STOJĄCA (BEZ KORKA)  
**RO071K..** BATERIA UMYWALKOWA STOJĄCA (KOREK CLICK CLACK)

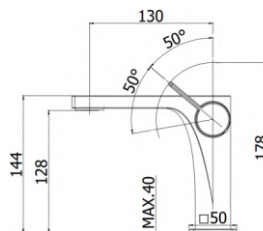

**INDEKS RO071**  
**CR** CHROM 700,00  
**\*ST** STAL SZCZOTKOWANA 1100,00

**INDEKS RO071K**  
**CR** CHROM 780,00  
**\*ST** STAL SZCZOTKOWANA 1340,00



**RO081..** BATERIA UMYWALKOWA WYSOKA (BEZ KORKA)  
**RO081K..** BATERIA UMYWALKOWA WYSOKA (KOREK CLICK CLACK)

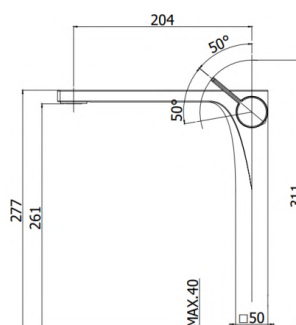

**INDEKS RO081**  
**CR** CHROM 1120,00  
**\*ST** STAL SZCZOTKOWANA 1700,00

**INDEKS RO081K**  
**CR** CHROM 1200,00  
**\*ST** STAL SZCZOTKOWANA 1940,00

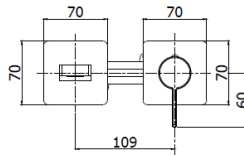

- RO104..70**     BATERIA UMYWALKOWA PODTYNKOWA L-150MM
- RO105..70**     BATERIA UMYWALKOWA PODTYNKOWA L-200MM
- RO106..70**     BATERIA UMYWALKOWA PODTYNKOWA L-240MM

<b>CR</b>	CHROM	<b>1300,00</b>
<b>*ST</b>	STAL SZCZOTKOWANA	<b>2300,00</b>

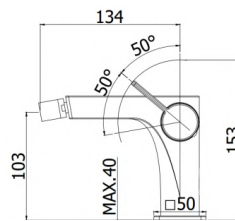

- RO131..**     BATERIA BIDETOWA STOJĄCA (BEZ KORKA)
- RO131K..**     BATERIA BIDETOWA STOJĄCA (KOREK CLICK CLACK)

	<b>INDEKS RO131</b>	
<b>CR</b>	CHROM	<b>700,00</b>
<b>*ST</b>	STAL SZCZOTKOWANA	<b>1100,00</b>

	<b>INDEKS RO131K</b>	
<b>CR</b>	CHROM	<b>780,00</b>
<b>*ST</b>	STAL SZCZOTKOWANA	<b>1340,00</b>

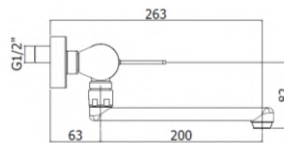

- RO161..**     BATERIA UMYWALKOWA ŚCIENNA

<b>CR</b>	CHROM	<b>750,00</b>
<b>*ST</b>	STAL SZCZOTKOWANA	<b>1200,00</b>

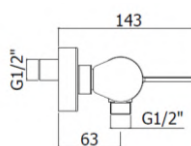

- RO168..**     BATERIA NATRYSKOWA ŚCIENNA (KORPUS)
- RO168D..**     BATERIA NATRYSKOWA ŚCIENNA (KOMPLETNA)

	<b>INDEKS RO168</b>	
<b>CR</b>	CHROM	<b>690,00</b>
<b>*ST</b>	STAL SZCZOTKOWANA	<b>1050,00</b>

	<b>INDEKS RO168D</b>	
<b>CR</b>	CHROM	<b>860,00</b>
<b>*ST</b>	STAL SZCZOTKOWANA	<b>1300,00</b>



SKŁAD ZESTAWU:  
 - ZESTAW 3W1 ZDUP095  
 - WYLEWKA L-17cm SK4704 -DANIEL-

**RO018ZWW..** ZESTAW WANNOWY PODTYNKOWY

<b>CR</b>	CHROM	<b>1985,00</b>
<b>*ST</b>	STAL SZCZOTKOWANA	<b>3750,00</b>



SKŁAD ZESTAWU:  
 - DESZCZOWNICA:  
 (INDEKS A) ZSOF075 200x200MM  
 (INDEKS B) SNK300 300x300MM, SLIM -AP-  
 (INDEKS E) C06658 300x300MM -EMMEVI-  
 (INDEKS F) SNK250 250x250MM, SLIM -AP-  
 - RAMIĘ ŚCIENNE L-400MM  
 - ZESTAW 3W1 ZDUP095  
 - WYLEWKA L-17cm SK4704 -DANIEL-

**RO019ZSCW3..** ZESTAW WANNOWY PODTYNKOWY Z WYLEWKĄ

	<b>INDEKS A</b> ZSOF075 200x200mm	
<b>CR</b>	CHROM	<b>2815,00</b>
<b>*ST</b>	STAL SZCZOTKOWANA	<b>5000,00</b>
	<b>INDEKS B</b> SNK300 300x300mm	
<b>CR</b>	CHROM	<b>2735,00</b>
	<b>INDEKS E</b> C06658 300x300mm	
<b>CR</b>	CHROM	<b>3075,00</b>
<b>*ST</b>	STAL SZCZOTKOWANA	<b>5700,00</b>



SKŁAD ZESTAWU:  
 - DESZCZOWNICA:  
 (INDEKS A) ZSOF075 200x200MM  
 (INDEKS B) SNK300 300x300MM, SLIM -AP-  
 (INDEKS E) C06658 300x300MM -EMMEVI-  
 (INDEKS F) SNK250 250x250MM, SLIM -AP-  
 - RAMIĘ ŚCIENNE L-400MM  
 - ZESTAW 3W1 ZDUP095

**RO015ZSC3..** ZESTAW NATRYSKOWY PODTYNKOWY

	<b>INDEKS A</b> ZSOF075 200x200mm	
<b>CR</b>	CHROM	<b>1745,00</b>
<b>ST</b>	STAL SZCZOTKOWANA	<b>3400,00</b>
	<b>INDEKS B</b> SNK300 300x300mm	
<b>CR</b>	CHROM	<b>1655,00</b>
	<b>INDEKS E</b> C06658 300x300mm	
<b>CR</b>	CHROM	<b>2065,00</b>
<b>*ST</b>	STAL SZCZOTKOWANA	<b>4130,00</b>

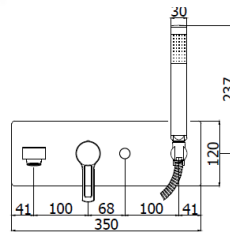

CR  
NO

CHROM  
CZARNY MAT

2000,00  
2570,00

**RIN/WS001..** BATERIA WANNOWA PODTYNKOWA ZESPOLONA

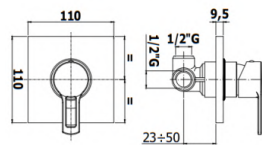

CR  
NO

CHROM  
CZARNY MAT

270,00  
500,00

**RIN/WS010..** BATERIA PODTYNKOWA 1-DROŻNA

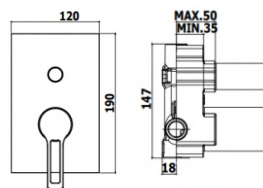

CR  
NO

CHROM  
CZARNY MAT

530,00  
930,00

**RIN/WS015..** BATERIA PODTYNKOWA 2-DROŻNA

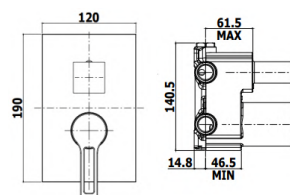

CR  
NO

CHROM  
CZARNY MAT

950,00  
1470,00

**RIN/WS018..** BATERIA PODTYNKOWA 2-DROŻNA Z PRZEŁĄCZNIKIEM MECHANICZNYM

**RIN/WS019..** BATERIA PODTYNKOWA 3-DROŻNA Z PRZEŁĄCZNIKIEM MECHANICZNYM



**RIN/WS022..** BATERIA WANNOWA ŚCIENNA (KORPUS)  
**RIN/WS023..** BATERIA WANNOWA ŚCIENNA (KOMPLETNA)

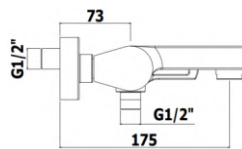

INDEKS **RIN022** LUB **WS022**

<b>CR</b>	CHROM	<b>960,00</b>
<b>NO</b>	CZARNY MAT	<b>1250,00</b>

INDEKS **RIN023** LUB **WS023**

<b>CR</b>	CHROM	<b>1130,00</b>
<b>NO</b>	CZARNY MAT	<b>1460,00</b>



**RIN/WS040..** BATERIA WANNOWA 3-OTWOROWA  
**RIN/WS041..** BATERIA WANNOWA 2-OTWOROWA (BEZ WYLEWKI)

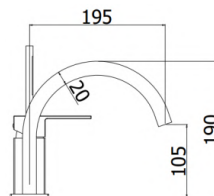

INDEKS **RIN040** LUB **WS040**

<b>CR</b>	CHROM	<b>1950,00</b>
<b>NO</b>	CZARNY MAT	<b>2500,00</b>

INDEKS **RIN041** LUB **WS041**

<b>CR</b>	CHROM	<b>1200,00</b>
<b>NO</b>	CZARNY MAT	<b>1500,00</b>



**RIN/WS071..** BATERIA UMYWALKOWA STOJĄCA (BEZ KORKA)  
**RIN/WS071K..** BATERIA UMYWALKOWA STOJĄCA (KOREK CLICK CLACK)

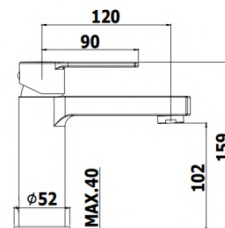

INDEKS **RIN071** LUB **WS071**

<b>CR</b>	CHROM	<b>480,00</b>
<b>NO</b>	CZARNY MAT	<b>640,00</b>

INDEKS **RIN071K** LUB **WS071K**

<b>CR</b>	CHROM	<b>560,00</b>
<b>NO</b>	CZARNY MAT	<b>760,00</b>



**RIN/WS074..** BATERIA UMYWALKOWA STOJĄCA XL (BEZ KORKA)  
**RIN/WS074K..** BATERIA UMYWALKOWA STOJĄCA XL (KOREK CLICK CLACK)

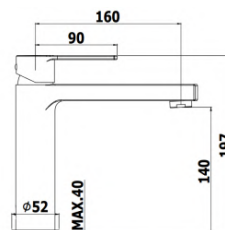

INDEKS **RIN074** LUB **WS074**

<b>CR</b>	CHROM	<b>590,00</b>
<b>NO</b>	CZARNY MAT	<b>840,00</b>

INDEKS **RIN074K** LUB **WS074K**

<b>CR</b>	CHROM	<b>670,00</b>
<b>NO</b>	CZARNY MAT	<b>960,00</b>



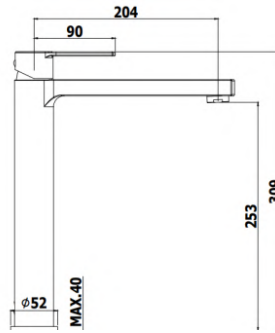

**RIN/WS081..** BATERIA UMYWALKOWA WYSOKA (BEZ KORKA)  
**RIN/WS081K..** BATERIA UMYWALKOWA WYSOKA (KOREK CLICK CLACK)

**INDEKS RIN081 LUB WS081**

<b>CR</b>	CHROM	<b>820,00</b>
<b>NO</b>	CZARNY MAT	<b>1100,00</b>

**INDEKS RIN081K LUB WS081K**

<b>CR</b>	CHROM	<b>900,00</b>
<b>NO</b>	CZARNY MAT	<b>1220,00</b>

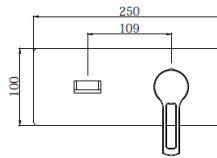

**RIN/WS104..** BATERIA UMYWALKOWA PODTYNKOWA L-150MM  
**RIN/WS105..** BATERIA UMYWALKOWA PODTYNKOWA L-200MM  
**RIN/WS106..** BATERIA UMYWALKOWA PODTYNKOWA L-240MM

<b>CR</b>	CHROM	<b>1250,00</b>
<b>NO</b>	CZARNY MAT	<b>1600,00</b>

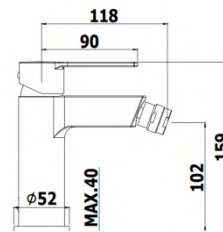

**RIN/WS131..** BATERIA BIDETOWA STOJĄCA (BEZ KORKA)  
**RIN/WS131K..** BATERIA BIDETOWA STOJĄCA (KOREK CLICK CLACK)

**INDEKS RIN131 LUB WS131**

<b>CR</b>	CHROM	<b>480,00</b>
<b>NO</b>	CZARNY MAT	<b>640,00</b>

**INDEKS RIN131K LUB WS131K**

<b>CR</b>	CHROM	<b>560,00</b>
<b>NO</b>	CZARNY MAT	<b>760,00</b>

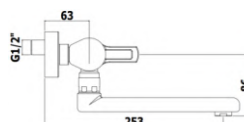

**RIN/WS161..** BATERIA UMYWALKOWA ŚCIENNA

<b>CR</b>	CHROM	<b>750,00</b>
<b>NO</b>	CZARNY MAT	<b>950,00</b>



**RIN/WS168..** BATERIA NATRYSKOWA ŚCIENNA (KORPUS)  
**RIN/WS168D..** BATERIA NATRYSKOWA ŚCIENNA (KOMPLETNA)

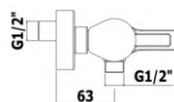

INDEKS RIN168 LUB WS168		
CR	CHROM	670,00
NO	CZARNY MAT	880,00

INDEKS RIN168D LUB WS168D		
CR	CHROM	880,00
NO	CZARNY MAT	1150,00



**RIN/WS180..** BATERIA ZLEWOZMYWAKOWA STOJĄCA

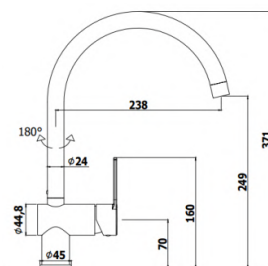

CR	CHROM	650,00
NO	CZARNY MAT	880,00



**RIN/WS184..** BATERIA ZLEWOZMYWAKOWA STOJĄCA Z PODŁĄCZENIEM DO ZMYWARKI

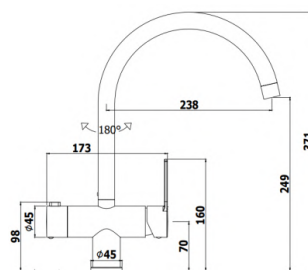

CR	CHROM	900,00
*NO	CZARNY MAT	1200,00



**RIN/WS185..** BATERIA ZLEWOZMYWAKOWA STOJĄCA

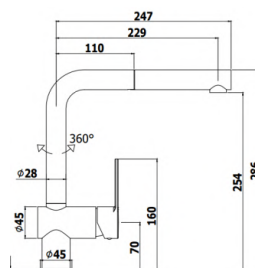

CR	CHROM	690,00
NO	CZARNY MAT	900,00

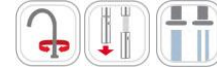
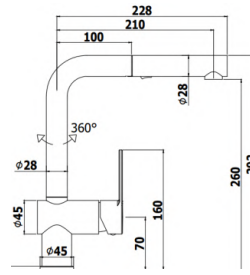

CR CHROM 740,00  
NO CZARNY MAT 960,00

RIN/WS285.. BATERIA ZLEWOZMYWAKOWA STOJĄCA

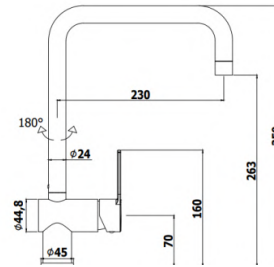

CR CHROM 660,00  
NO CZARNY MAT 860,00

RIN/WS980.. BATERIA ZLEWOZMYWAKOWA STOJĄCA

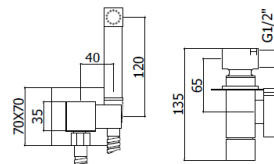

INDEKS 22685  
CR CHROM 600,00

22685.. BATERIA BIDETOWA PODTYNKOWA VIOLA (KOMPLETNA)

ZDUP112.. BATERIA BIDETOWA PODTYNKOWA VIOLA (KOMPLETNA) CZARNY MAT

INDEKS ZDUP112  
NO CZARNY MAT 900,00



SKŁAD ZESTAWU:  
- ZESTAW 3W1 ZDUP095  
- WYLEWKA ŚCIENNA SK4704 \*DANIEL\*



CR CHROM 1505,00  
NO CZARNY MAT 2630,00

RIN/WS015ZWW.. ZESTAW WANNOWY PODTYNKOWY Z WYLEWKĄ L-17CM



**SKŁAD ZESTAWU:**

- DESZCZOWNICA:  
(INDEKS A) ZSOF075 **200x200MM**  
(INDEKS B) SNK300 **300x300MM, SLIM -AP-**  
(INDEKS E) C06658 **300x300MM -EMMEVI-**
- RAMIĘ ŚCIENNE L-400MM
- ZESTAW 3w1 ZDUP095
- WYLEWKA ŚCIENNA L-17cm SK4704 -DANIEL-



**INDEKS A ZSOF075 200x200mm**

<b>CR</b>	CHROM	<b>2815,00</b>
<b>NO</b>	CZARNY MAT	<b>4305,00</b>

**INDEKS B SNK300 300x300mm**

<b>CR</b>	CHROM	<b>2735,00</b>
-----------	-------	----------------

**INDEKS E C06658 300x300mm**

<b>CR</b>	CHROM	<b>3135,00</b>
<b>NO</b>	CZARNY MAT	<b>5065,00</b>

**RIN/WS019ZSCW3..** ZESTAW WANNOWY PODTYNKOWY Z WYLEWKĄ



**SKŁAD ZESTAWU:**

- DESZCZOWNICA:  
(INDEKS A) ZSOF075 **200x200MM**  
(INDEKS B) SNK300 **300x300MM, SLIM -AP-**  
(INDEKS E) C06658 **300x300MM -EMMEVI-**
- RAMIĘ ŚCIENNE L-400MM
- ZESTAW 3w1 ZDUP095



**INDEKS A ZSOF075 200x200mm**

<b>CR</b>	CHROM	<b>1725,00</b>
<b>NO</b>	CZARNY MAT	<b>2885,00</b>

**INDEKS B SNK300 300x300mm**

<b>CR</b>	CHROM	<b>1645,00</b>
-----------	-------	----------------

**INDEKS E C06658 300x300mm**

<b>CR</b>	CHROM	<b>2045,00</b>
<b>NO</b>	CZARNY MAT	<b>3645,00</b>

**RIN/WS015ZSC3..** ZESTAW NATRYSKOWY PODTYNKOWY



**SKŁAD ZESTAWU:**  
 - DESZCZOWNICA:  
 (INDEKS A) ZSOF075 **200x200MM**  
 (INDEKS B) SNK300 **300x300MM, SLIM -AP-**  
 (INDEKS E) C06658 **300x300MM -EMMEVI-**  
 - RAMIĘ ŚCIENNE L-400MM  
 - ZESTAW 3W1 ZDUP095



**INDEKS A** ZSOF075 **200x200mm**  
**CR** CHROM **4000,00**  
**NO** CZARNY MAT **5915,00**

**INDEKS B** SNK300 **300x300mm**  
**CR** CHROM **3920,00**

**INDEKS E** C06658 **300x300mm**  
**CR** CHROM **4320,00**  
**NO** CZARNY MAT **6105,00**

**CPT518ZSC3..** ZESTAW NATRYSKOWY PODTYNKOWY **TERMOSTAT**

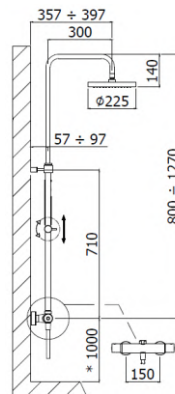

**INDEKS ZCOL638LIQ**  
**CR** CHROM **2000,00**  
**NO** CZARNY MAT **3300,00**

**ZCOL638LIQ..** KOLUMNA NATRYSKOWA **TERMOSTAT** **∅200MM**  
**ZCOL638KLIQ..** KOLUMNA NATRYSKOWA **TERMOSTAT** **∅300MM**

**INDEKS ZCOL638KLIQ**  
**CR** CHROM **2600,00**  
**NO** CZARNY MAT **3800,00**

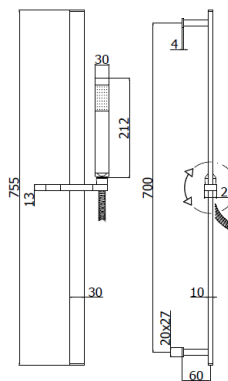

**CR** CHROM **650,00**  
**NO** CZARNY MAT **850,00**

**ZSAL145..** ZESTAW NATRYSKOWY **CITY**

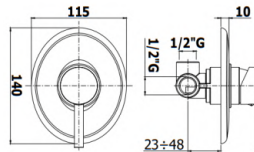

**BR010..**

BATERIA PODTYNKOWA 1-DROŻNA

CR

CHROM

260,00

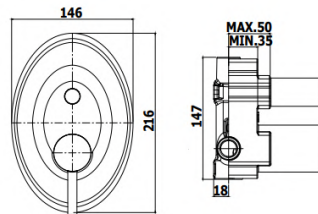

**BR015..**

BATERIA PODTYNKOWA 2-DROŻNA

CR

CHROM

580,00

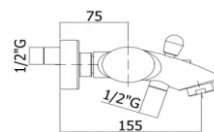

**BR022..**

BATERIA WANNOWA ŚCIENNA (KORPUS)

CR

INDEKS **BR022**  
CHROM

800,00

**BR023..**

BATERIA WANNOWA ŚCIENNA (KOMPLETNA)

CR

INDEKS **BR023**  
CHROM

990,00

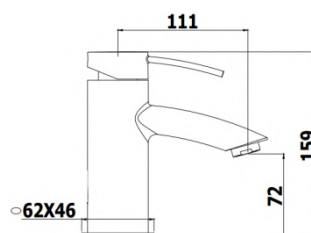

**BR071..**

BATERIA UMYWALKOWA STOJĄCA (BEZ KORKA)

CR

INDEKS **BR071**  
CHROM

465,00

**BR071K..**

BATERIA UMYWALKOWA STOJĄCA (KOREK CLICK CLACK)

CR

INDEKS **BR071K**  
CHROM

545,00

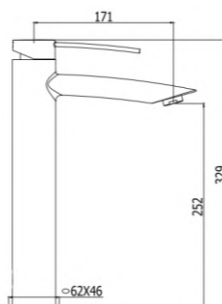

**BR081..** BATERIA UMYWALKOWA WYSOKA (BEZ KORKA)  
**BR081K..** BATERIA UMYWALKOWA WYSOKA (KOREK CLICK CLACK)

**INDEKS BR081**  
**CR** CHROM 930,00

**INDEKS BR081K**  
**CR** CHROM 1010,00

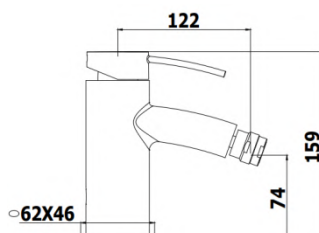

**BR131..** BATERIA BIDETOWA STOJĄCA (BEZ KORKA)  
**BR131K..** BATERIA BIDETOWA STOJĄCA (KOREK CLICK CLACK)

**INDEKS BR131**  
**CR** CHROM 465,00

**INDEKS BR131K**  
**CR** CHROM 545,00



**SKŁAD ZESTAWU:**  
 - DESZCZOWNICA:  
 (INDEKS A) ZSOF074  
 - RAMIĘ ŚCIENNE L-400MM  
 - ZESTAW 3W1 ZDUP094

$\varnothing 225\text{MM}$

**BR015ZSC3A** ZESTAW NATRYSKOWY PODTYNKOWY

**1600,00**

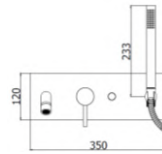

**SK001..**

BATERIA WANNOWA PODTYNKOWA ZESPOLONA

**CR**  
**\*ST**

CHROM  
STAL SZCZOTKOWANA

**1960,00**  
**3000,00**

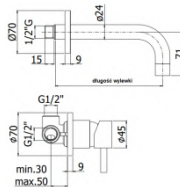

**SK004..**

BATERIA UMYWALKOWA PODTYNKOWA L-120MM

**SK006..**

BATERIA UMYWALKOWA PODTYNKOWA L-175MM

**SK007..**

BATERIA UMYWALKOWA PODTYNKOWA L-245MM

**INDEKS SK004**

**CR**  
**\*ST**

CHROM  
STAL SZCZOTKOWANA

**590,00**  
**900,00**

**INDEKS SK006**

**CR**  
**\*ST**

CHROM  
STAL SZCZOTKOWANA

**590,00**  
**900,00**

**INDEKS SK007**

**CR**  
**\*ST**

CHROM  
STAL SZCZOTKOWANA

**620,00**  
**920,00**

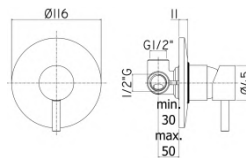

**SK010..**

BATERIA PODTYNKOWA 1-DROŻNA  $\varnothing$ 116MM

**CR**  
**\*ST**

CHROM  
STAL SZCZOTKOWANA

**240,00**  
**360,00**

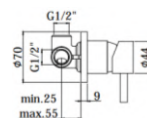

**SK010..70**

BATERIA PODTYNKOWA 1-DROŻNA  $\varnothing$ 70MM

**CR**

CHROM

**360,00**





**SK015..**

BATERIA PODTYNKOWA 2-DROŻNA

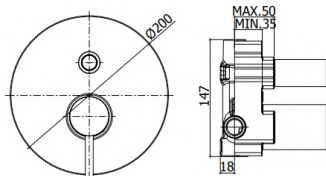

**CR**  
**ST**

CHROM  
STAL SZCZOTKOWANA

**570,00**  
**1020,00**



**SK018..**

BATERIA PODTYNKOWA 2-DROŻNA Z PRZEŁĄCZNIKIEM MECHANICZNYM

**SK019..**

BATERIA PODTYNKOWA 3-DROŻNA Z PRZEŁĄCZNIKIEM MECHANICZNYM

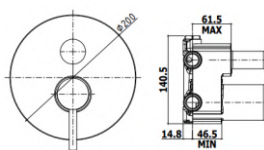

**CR**  
**ST**

CHROM  
STAL SZCZOTKOWANA

**1000,00**  
**1500,00**



**CPT013..**

BATERIA PODTYNKOWA **TERMOSAT** 1-DROŻNA (KOMPLETNA Z **CPBOX**)

**CPT018..**

BATERIA PODTYNKOWA **TERMOSAT** 2-DROŻNA (KOMPLETNA Z **CPBOX**)

**CPT019..**

BATERIA PODTYNKOWA **TERMOSAT** 3-DROŻNA (KOMPLETNA Z **CPBOX**)

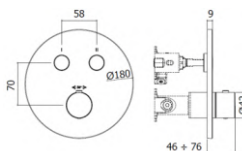

**CR**  
**ST**

CHROM  
STAL SZCZOTKOWANA

**2800,00**  
**3900,00**



**LIQ013..**

BATERIA PODTYNKOWA **TERMOSAT** 1-DROŻNA

**LIQ018..**

BATERIA PODTYNKOWA **TERMOSAT** 2-DROŻNA

**LIQ019..**

BATERIA PODTYNKOWA **TERMOSAT** 3-DROŻNA

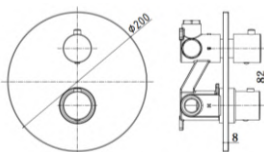

**CR**  
**ST**

CHROM  
STAL SZCZOTKOWANA

**1420,00**  
**2200,00**



**SK022..** BATERIA WANNOWA ŚCIENNA (KORPUS)  
**SK023..** BATERIA WANNOWA ŚCIENNA (KOMPLETNA)

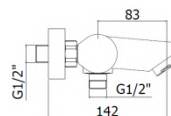

**INDEKS SK022**  
**CR** CHROM 680,00  
**\*ST** STAL SZCZOTKOWANA 1020,00

**INDEKS SK023**  
**CR** CHROM 800,00  
**\*ST** STAL SZCZOTKOWANA 1230,00



**SK040L..** BATERIA WANNOWA 3-OTWOROWA  
**SK041L..** BATERIA WANNOWA 2-OTWOROWA (BEZ WYLEWKI)

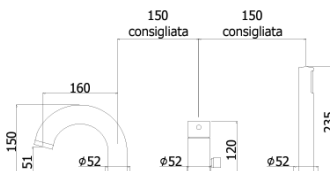

**INDEKS SK04L**  
**CR** CHROM 1400,00  
**ST** STAL SZCZOTKOWANA 2500,00

**INDEKS SK041L**  
**CR** CHROM 1000,00  
**ST** STAL SZCZOTKOWANA 2000,00



**SK071H..** BATERIA UMYWALKOWA STOJĄCA (BEZ KORKA)  
**SK071HK..** BATERIA UMYWALKOWA STOJĄCA (KOREK CLICK CLACK)  
**SK075H..** BATERIA UMYWALKOWA STOJĄCA (KOREK AUTOMATYCZNY)  
**SK071H-EWS..** BATERIA UMYWALKOWA STOJĄCA (BEZ KORKA) COLD START

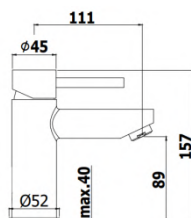

**INDEKS SK071**  
**CR** CHROM 400,00  
**\*ST** STAL SZCZOTKOWANA 600,00

**INDEKS SK071K**  
**CR** CHROM 480,00  
**\*ST** STAL SZCZOTKOWANA 840,00

**INDEKS SK075**  
**CR** CHROM 480,00  
**\*ST** STAL SZCZOTKOWANA 840,00

**INDEKS SK071-EWS**  
**CR** CHROM 420,00  
**\*ST** STAL SZCZOTKOWANA 700,00



**SK071H..120** BATERIA UMYWALKOWA WYSOKA (BEZ KORKA)  
**SK071H..120K** BATERIA UMYWALKOWA WYSOKA (KOREK CLICK CLACK)

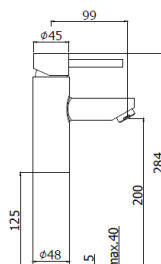

**INDEKS SK071..120**  
**CR** CHROM 550,00  
**\*ST** STAL SZCZOTKOWANA 900,00

**INDEKS SK071..120K**  
**CR** CHROM 630,00  
**\*ST** STAL SZCZOTKOWANA 1140,00

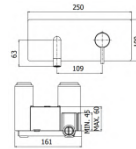

- SK104..** BATERIA UMYWALKOWA PODTYNKOWA L-123MM
- SK105..** BATERIA UMYWALKOWA PODTYNKOWA L-178MM
- SK106..** BATERIA UMYWALKOWA PODTYNKOWA L-248MM

<b>CR</b>	CHROM	<b>1000,00</b>
<b>*ST</b>	STAL SZCZOTKOWANA	<b>1500,00</b>

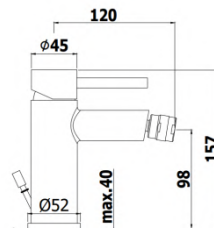

- SK131..** BATERIA BIDETOWA STOJĄCA (BEZ KORKA)
- SK131K..** BATERIA BIDETOWA STOJĄCA (KOREK CLICK CLACK)
- SK135..** BATERIA BIDETOWA STOJĄCA (KOREK AUTOMATYCZNY)

	<b>INDEKS SK131</b>	
<b>CR</b>	CHROM	<b>400,00</b>
<b>*ST</b>	STAL SZCZOTKOWANA	<b>600,00</b>

	<b>INDEKS SK131K</b>	
<b>CR</b>	CHROM	<b>480,00</b>
<b>*ST</b>	STAL SZCZOTKOWANA	<b>840,00</b>

	<b>INDEKS SK135</b>	
<b>CR</b>	CHROM	<b>480,00</b>
<b>*ST</b>	STAL SZCZOTKOWANA	<b>840,00</b>

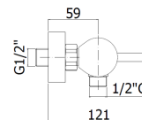

- SK168..** BATERIA NATRYSKOWA ŚCIENNA (KORPUS)
- SK168D..** BATERIA NATRYSKOWA ŚCIENNA (KOMPLETNA)

	<b>INDEKS SK168</b>	
<b>CR</b>	CHROM	<b>590,00</b>
<b>*ST</b>	STAL SZCZOTKOWANA	<b>880,00</b>

	<b>INDEKS SK168D</b>	
<b>CR</b>	CHROM	<b>740,00</b>
<b>*ST</b>	STAL SZCZOTKOWANA	<b>1100,00</b>

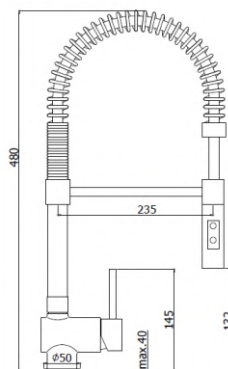

- SK176..** BATERIA ZLEWOZMYWAKOWA STOJĄCA Z WĘŻEM OPERACYJNYM
- SK177..** BATERIA ZLEWOZMYWAKOWA STOJĄCA Z WĘŻEM OPERACYJNYM
- SK178..** BATERIA ZLEWOZMYWAKOWA STOJĄCA Z WĘŻEM OPERACYJNYM
- SK179..** BATERIA ZLEWOZMYWAKOWA STOJĄCA Z WĘŻEM OPERACYJNYM

176 - 177 - 178 - 179



<b>CR</b>	CHROM	<b>1190,00</b>
<b>ST</b>	STAL SZCZOTKOWANA	<b>1800,00</b>

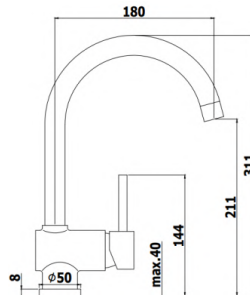

**CR** CHROM 540,00  
**\*ST** STAL SZCZOTKOWANA 800,00

**SK180..** BATERIA ZLEWOZMYWAKOWA STOJĄCA

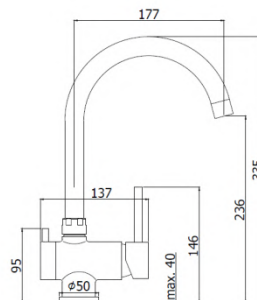

**CR** CHROM 800,00  
**\*ST** STAL SZCZOTKOWANA 1300,00

**SK184..** BATERIA ZLEWOZMYWAKOWA STOJĄCA (Z PODŁĄCZENIEM DO ZMYWARKI)  
**SK190..** BATERIA ZLEWOZMYWAKOWA STOJĄCA (Z PODŁĄCZENIEM DO WODY FILTROWANEJ)

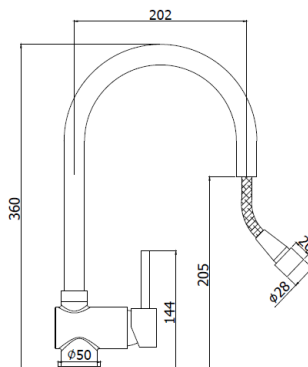

**CR** CHROM 840,00  
**ST** STAL SZCZOTKOWANA 1300,00

**SK185..** BATERIA ZLEWOZMYWAKOWA STOJĄCA Z WĘŻEM OPERACYJNYM

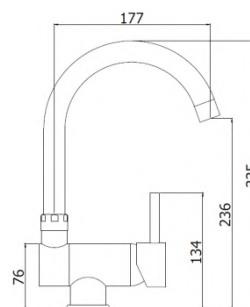

**CR** CHROM 760,00  
**\*ST** STAL SZCZOTKOWANA 1150,00

**SK189..** BATERIA ZLEWOZMYWAKOWA PODOKIENNA



**22704..**  
**ZDUP110..**

BATERIA BIDETOWA PODTYNKOWA **SANY** (KOMPLETNA)

BATERIA BIDETOWA PODTYNKOWA **SANY** (KOMPLETNA)

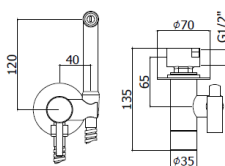

INDEKS **22704**

**CR** CHROM **520,00**

INDEKS **ZDUP110**

**ST** STAL SZCZOTKOWANA **950,00**



**MDE001..**

BATERIA WANNOWA PODTYNKOWA (ZESPOLONA) TERMOSTAT L-208MM

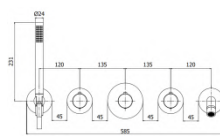

**CR** CHROM **6000,00**

**ST** STAL SZCZOTKOWANA **7000,00**



**SK010CR70ZWW**

ZESTAW WANNOWY Z WYLEWKĄ

- ZESTAW 3w1 ZDUP094  
- WYLEWKĄ ŚCIENNA L-17,5cm ZBOC081

**1460,00**



**SK015ZWW**  
**SK015ZWW.ST**

ZESTAW WANNOWY Z WYLEWKĄ L-175MM

ZESTAW WANNOWY Z WYLEWKĄ L-175MM **STAL SZCZOTKOWANA**

- ZESTAW 3w1 ZDUP094  
- WYLEWKĄ ŚCIENNA L-17,5cm ZBOC081

**1290,00**

**2360,00**



**SKŁAD ZESTAWU:**

- DESZCZOWNICA:  
(INDEKS A) ZSOF074 **Ø225MM**,  
(INDEKS B) SNO300 **Ø300MM**, WERSJA **SLIM** –AP-  
(INDEKS F) SNO250 **Ø250MM**, WERSJA **SLIM** –AP-
- RAMIĘ ŚCIENNE **L-400MM**
- ZESTAW 3w1 ZDUP094
- WYLEWKA ŚCIENNA **L-17,5cm** ZBOC081



	<b>INDEKS A</b>	ZSOF074	<b>Ø225mm</b>
<b>A.CR</b>		CHROM	<b>2515,00</b>
<b>A.ST</b>		STAL SZCZOTKOWANA	<b>4260,00</b>

	<b>INDEKS B</b>	SNO300	<b>Ø300mm</b>
<b>B.CR</b>		CHROM	<b>2485,00</b>

	<b>INDEKS F</b>	SNO250	<b>Ø250mm</b>
<b>F.CR</b>		CHROM	<b>2405,00</b>

**SK019ZSCW3..** ZESTAW WANNOWY PODTYNKOWY Z WYLEWKĄ



**SKŁAD ZESTAWU:**

- DESZCZOWNICA:  
(INDEKS A) ZSOF074 **Ø225MM**,  
(INDEKS B) SNO300 **Ø300MM**, WERSJA **SLIM** –AP-  
(INDEKS F) SNO250 **Ø250MM**, WERSJA **SLIM** –AP-
- RAMIĘ ŚCIENNE **L-400MM**
- ZESTAW 3w1 ZDUP094
- SYFON WANNOWY Z NAPEŁNIENIEM PRZEZ PRZELEW D6 –CRS-



	<b>INDEKS A</b>	ZSOF074	<b>Ø225mm</b>
<b>A.CR</b>		CHROM	<b>2685,00</b>
<b>A.ST</b>		STAL SZCZOTKOWANA	<b>4530,00</b>

	<b>INDEKS B</b>	SNO300	<b>Ø300mm</b>
<b>B.CR</b>		CHROM	<b>2655,00</b>

	<b>INDEKS F</b>	SNO250	<b>Ø250mm</b>
<b>F.CR</b>		CHROM	<b>2575,00</b>

**SK019ZWSCSU3..** ZESTAW WANNOWY P/T Z NAPEŁNIENIEM PRZEZ PRZELEW



**SKŁAD ZESTAWU:**

- DESZCZOWNICA:  
(INDEKS **A**) ZSOF074 **Ø225mm**,
- (INDEKS **B**) SNO300 **Ø300mm**, WERSJA **SLIM** –AP-
- (INDEKS **F**) SNO250 **Ø250mm**, WERSJA **SLIM** –AP-
- RAMIĘ ŚCIENNE **L-400mm**
- ZESTAW 3w1 ZDUP094



**INDEKS A** ZSOF074 **Ø225mm**  
**3A.CR** CHROM **1805,00**

**INDEKS B** SNO300 **Ø300mm**  
**3B.CR** CHROM **1775,00**

**INDEKS F** SNO250 **Ø250mm**  
**F.CR** CHROM **1695,00**

**SK010CR70ZSC..**

ZESTAW NATRYSKOWY PODTYNKOWY



**SKŁAD ZESTAWU:**

- DESZCZOWNICA:  
(INDEKS **A**) ZSOF074 **Ø225mm**
- (INDEKS **B**) SNO300 **Ø300mm**, WERSJA **SLIM** –AP-
- (INDEKS **F**) SNO250 **Ø250mm**, WERSJA **SLIM** –AP-
- RAMIĘ ŚCIENNE **L-400mm**
- ZESTAW 3w1 ZDUP094



**INDEKS A** ZSOF074 **Ø225mm**  
**A.CR** CHROM **1675,00**

**A.ST** STAL SZCZOTKOWANA **3080,00**

**INDEKS B** SNO300 **Ø300mm**  
**B.CR** CHROM **1525,00**

**INDEKS F** SNO250 **Ø250mm**  
**F.CR** CHROM **1445,00**

**SK015ZSC3..**

ZESTAW NATRYSKOWY PODTYNKOWY (RAMIĘ L-400MM)



**SKŁAD ZESTAWU:**

- DESZCZOWNICA:  
(INDEKS A) ZSOF074 **Ø225MM**  
(INDEKS B) SNO300 **Ø300MM**, WERSJA SLIM –AP-  
(INDEKS F) SNO250 **Ø250MM**, WERSJA SLIM –AP-
- RAMIĘ SUFITOWE L-120MM
- ZESTAW Z RĄCZKĄ I WĘŻEM ZDUP094



	<b>INDEKS A</b>	ZSOF074	<b>Ø225mm</b>
<b>A.CR</b>	CHROM		<b>1580,00</b>
<b>A.ST</b>	STAL SZCZOTKOWANA		<b>2870,00</b>
	<b>INDEKS B</b>	SNO300	<b>Ø300mm</b>
<b>B.CR</b>	CHROM		<b>1435,00</b>
	<b>INDEKS F</b>	SNO250	<b>Ø250mm</b>
<b>F.CR</b>	CHROM		<b>1355,00</b>

**SK015ZSU2..** ZESTAW NATRYSKOWY PODTYNKOWY



**SKŁAD ZESTAWU:**

- DESZCZOWNICA:  
(INDEKS A) ZSOF074 **Ø225MM**  
(INDEKS B) SNO300 **Ø300MM**, WERSJA SLIM –AP-  
(INDEKS F) SNO250 **Ø250MM**, WERSJA SLIM –AP-
- RAMIĘ ŚCIENNE L-400MM
- PODŁĄCZENIE PODTYNKOWE ZACC130
- ZESTAW NATRYSKOWY ZSAL135



	<b>INDEKS A</b>	ZSOF074	<b>Ø225mm</b>
<b>A.CR</b>	CHROM		<b>2010,00</b>
<b>A.ST</b>	STAL SZCZOTKOWANA		<b>3595,00</b>
	<b>INDEKS B</b>	SNO300	<b>Ø300mm</b>
<b>B.CR</b>	CHROM		<b>1980,00</b>
	<b>INDEKS F</b>	SNO250	<b>Ø250mm</b>
<b>F.CR</b>	CHROM		<b>1900,00</b>

**SK015ZN5..** ZESTAW NATRYSKOWY PODTYNKOWY (RAMIĘ L-400MM)



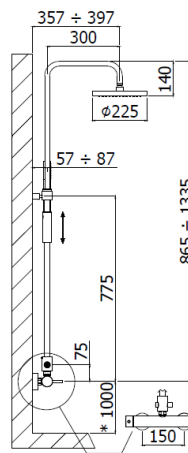

**ZCOL601..**

KOLUMNY NATRYSKOWA **MASTER PLUS**

**CR**

CHROM

**2200,00**

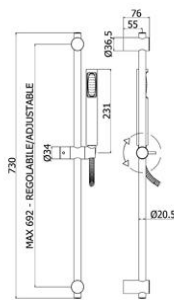

**ZSAL150..**

ZESTAW NATRYSKOWY **STICK NEW**

**CR**

CHROM

**300,00**

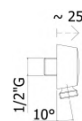

**ZACC130..**

PRZYŁĄCZE KĄTOWE METALOWE

**CR**  
**ST**

CHROM  
STAL SZCZOTKOWANA

**75,00**  
**115,00**

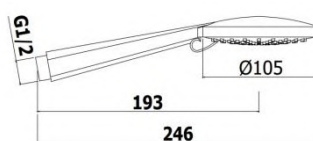

**ZDOC104..**

RĄCZKA NATRYSKOWA **BRIO**

**CR**

CHROM

**85,00**

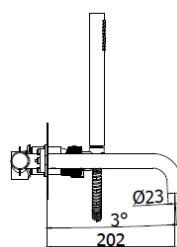

**JO/JK001..** BATERIA WANNOWA PODTYNKOWA ZESPOLONA

**CR** CHROM 2000,00  
**NO** CZARNY MAT 2560,00

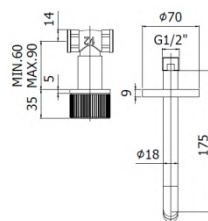

**JO003..** BATERIA UMYWALKOWA PODTYNKOWA L-175MM (BEZ KORKA)

**JO003K..** BATERIA UMYWALKOWA PODTYNKOWA L-175MM (KOREK CLICK CLACK)

**INDEKS JO003**  
**CR** CHROM 850,00  
**NO** CZARNY MAT 1105,00

**INDEKS JO003K**  
**CR** CHROM 930,00  
**NO** CZARNY MAT 1225,00

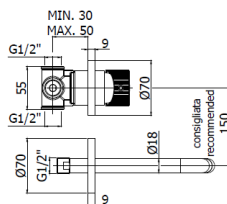

**JO/JK006..** BATERIA UMYWALKOWA PODTYNKOWA L-178MM (BEZ KORKA)

**JO/JK007..** BATERIA UMYWALKOWA PODTYNKOWA L-248MM (BEZ KORKA)

**CR** CHROM 630,00  
**NO** CZARNY MAT 800,00

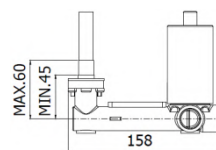

**JO/JK104..70** BATERIA UMYWALKOWA P/T ZINTEGROWANA L-128MM

**JO/JK105..70** BATERIA UMYWALKOWA P/T ZINTEGROWANA L-178MM

**JO/JK106..70** BATERIA UMYWALKOWA P/T ZINTEGROWANA L-248MM

**CR** CHROM 820,00  
**NO** CZARNY MAT 1060,00

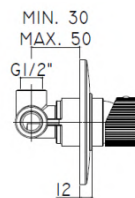

**JO/JK010..**

BATERIA PODTYNKOWA 1-DROŻNA  $\varnothing$ 116MM

**CR**  
**NO**

CHROM  
CZARNY MAT

**330,00**  
**590,00**

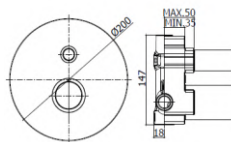

**JO/JK015..**

BATERIA PODTYNKOWA 2-DROŻNA

**CR**  
**NO**

CHROM  
CZARNY MAT

**675,00**  
**880,00**

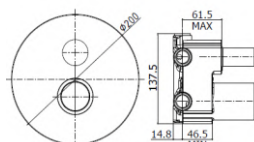

**JO/JK018..**

BATERIA PODTYNKOWA 2-DROŻNA Z PRZEŁĄCZNIKIEM MECHANICZNYM

**CR**  
**NO**

CHROM  
CZARNY MAT

**1100,00**  
**1425,00**

**JO/JK019..**

BATERIA PODTYNKOWA 3-DROŻNA Z PRZEŁĄCZNIKIEM MECHANICZNYM

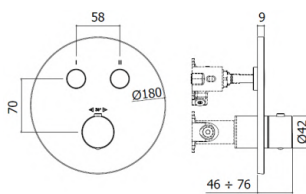

**CPT013..**

BATERIA PODTYNKOWA TERMOSTATYCZNA 1-DROŻNA (KOMPLETNA Z CPBOX)



**CR**  
**NO**

CHROM  
CZARNY MAT

**2800,00**  
**3700,00**

**CPT018..**

BATERIA PODTYNKOWA TERMOSTATYCZNA 2-DROŻNA (KOMPLETNA Z CPBOX)

**CPT019..**

BATERIA PODTYNKOWA TERMOSTATYCZNA 3-DROŻNA (KOMPLETNA Z CPBOX)

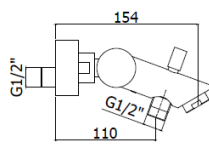

**JO/JK022..**

BATERIA WANNOWA ŚCIENNA (KORPUS)

**CR**  
**NO**

**INDEKS JO022 LUB JK022**  
CHROM **1100,00**  
CZARNY MAT **1420,00**

**JO/JK023..**

BATERIA WANNOWA ŚCIENNA (KOMPLETNA)

**CR**  
**NO**

**INDEKS JO023 LUB JK023**  
CHROM **1350,00**  
CZARNY MAT **1780,00**



**JO/JK047..**  
**JO/JK048..**

**BATERIA WANNOWA 3-OTWOROWA**  
**BATERIA WANNOWA 2-OTWOROWA (BEZ WYLEWKI)**

**INDEKS JO047 LUB JK047**  
**CR** CHROM **1700,00**  
**NO** CZARNY MAT **2200,00**

**INDEKS JO048 LUB JK048**  
**CR** CHROM **1260,00**  
**NO** CZARNY MAT **1700,00**



**JO044..**

**BATERIA WANNOWA 5-OTWOROWA**

**CR** CHROM **2300,00**  
**NO** CZARNY MAT **3000,00**



**JO052K..**

**BATERIA UMYWALKOWA 3-OTWOROWA (KOREK CLICK CLACK)**

**CR** CHROM **1100,00**  
**NO** CZARNY MAT **1420,00**



**JO/JK071..**  
**JO/JK071K..**

**BATERIA UMYWALKOWA STOJĄCA (BEZ KORKA)**  
**BATERIA UMYWALKOWA STOJĄCA (KOREK CLICK CLACK)**

**INDEKS JO071 LUB JK071**  
**CR** CHROM **680,00**  
**NO** CZARNY MAT **910,00**

**INDEKS JO071K LUB JK071K**  
**CR** CHROM **760,00**  
**NO** CZARNY MAT **1030,00**

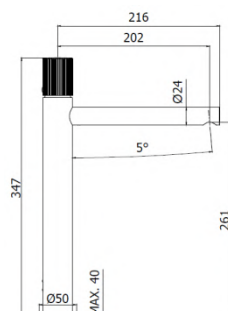

**JO/JK081..** BATERIA UMYWALKOWA WYSOKA (BEZ KORKA)  
**JO/JK0081K..** BATERIA UMYWALKOWA WYSOKA (KOREK CLICK CLACK)

**INDEKS JO081 LUB JK081**  
**CR** CHROM 1100,00  
**NO** CZARNY MAT 1450,00

**INDEKS JO081K LUB JK081K**  
**CR** CHROM 1180,00  
**NO** CZARNY MAT 1570,00

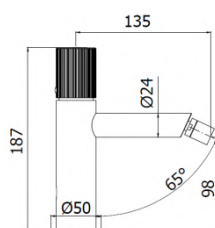

**JO/JK131..** BATERIA BIDETOWA STOJĄCA (BEZ KORKA)  
**JO/JK131K..** BATERIA BIDETOWA STOJĄCA (KOREK CLICK CLACK)

**INDEKS JO131 LUB JK131**  
**CR** CHROM 680,00  
**NO** CZARNY MAT 910,00

**INDEKS JO131K LUB JK131K**  
**CR** CHROM 760,00  
**NO** CZARNY MAT 1030,00

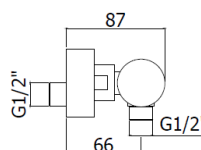

**JO/JK168..** BATERIA NATRYSKOWA ŚCIENNA (KORPUS)  
**JO/JK168D..** BATERIA NATRYSKOWA ŚCIENNA (KOMPLETNA)

**INDEKS JO168 LUB JK168**  
**CR** CHROM 970,00  
**NO** CZARNY MAT 1260,00

**INDEKS JO168D LUB JK168D**  
**CR** CHROM 1300,00  
**NO** CZARNY MAT 1660,00

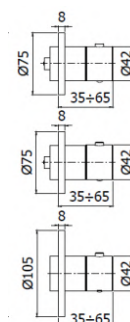
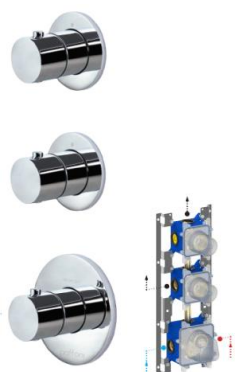

**MDE018..** BATERIA PODTYNKOWA 2-DROŻNA TERMOSTAT (PIONOWO-POZIOMO)



**CR** CHROM 3840,00  
**NO** CZARNY MAT 4100,00

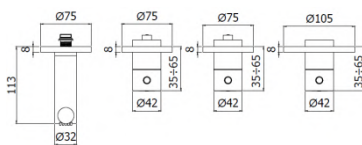

CR  
NO

CHROM  
CZARNY MAT

5000,00  
5400,00

**MDE000..** BATERIA PODTYNKOWA 2-DROŻNA (ZESPOLONA)

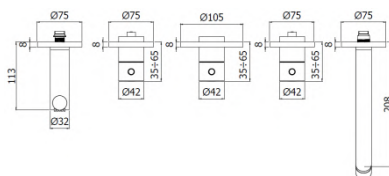
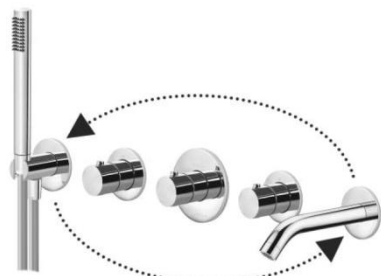

CR  
NO

CHROM  
CZARNY MAT

6000,00  
6600,00

**MDE001** BATERIA WANNOWA PODTYNKOWA (ZESPOLONA) TERMOSTAT L-208MM

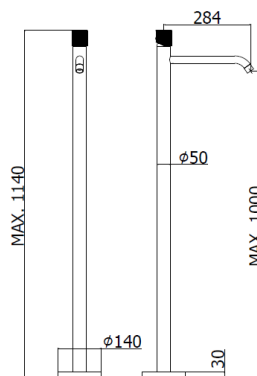

CR  
NO

CHROM  
CZARNY MAT

6000,00  
7500,00

**JO/JK031..** BATERIA UMYWALKOWA WOLNOSTOJĄCA (KOMPLETNA)

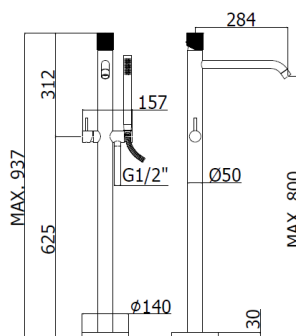

CR  
NO

CHROM  
CZARNY MAT

6500,00  
8200,00

**JO/JK032..** BATERIA WANNOWA WOLNOSTOJĄCA (KOMPLETNA)



**SKŁAD ZESTAWU:**  
 - ZESTAW 3w1 ZDUP094  
 - WYLEWKA ŚCIENNA L-17,5cm



<b>CR</b>	CHROM	<b>1360,00</b>
<b>NO</b>	CZARNY MAT	<b>1900,00</b>

**JO/JK015ZWW..** ZESTAW WANNOWY PODTYNKOWY



**SKŁAD ZESTAWU:**  
 - DESZCZOWNICA:  
 (INDEKS A) ZSOF074 **Ø225MM**  
 (INDEKS C) ZSOF079 **Ø300MM**  
 (INDEKS E) C06657 **Ø300MM -EMMEVI-**  
 - RAMIĘ ŚCIENNE L-400MM  
 - ZESTAW 3w1 ZDUP094  
 - WYLEWKA ŚCIENNA L-175MM



	<b>INDEKS A</b>	<b>ZSOF074</b>	<b>Ø225mm</b>
<b>CR</b>	CHROM		<b>2415,00</b>
<b>NO</b>	CZARNY MAT		<b>3525,00</b>

	<b>INDEKS C</b>	<b>ZSOF079</b>	<b>Ø300mm</b>
<b>CR</b>	CHROM		<b>2785,00</b>

	<b>INDEKS E</b>	<b>C06657</b>	<b>Ø300mm</b>
<b>NO</b>	CZARNY MAT		<b>4165,00</b>

**JO/JK019ZSCW3..** ZESTAW WANNOWY P/T Z WYLEWKĄ



**SKŁAD ZESTAWU:**  
 - DESZCZOWNICA:  
 (INDEKS A) ZSOF074 **Ø225MM**  
 (INDEKS C) ZSOF079 **Ø300MM**  
 (INDEKS E) C06657 **Ø300MM -EMMEVI-**  
 (INDEKS F) SNO250 **Ø250MM, WERSJA SLIM -AP-**  
 - RAMIĘ ŚCIENNE L-400MM  
 - ZESTAW 3w1 ZDUP094

	<b>INDEKS A</b>	<b>ZSOF074</b>	<b>Ø225mm</b>
<b>CR</b>	CHROM		<b>1705,00</b>
<b>NO</b>	CZARNY MAT		<b>2480,00</b>

	<b>INDEKS C</b>	<b>ZSOF079</b>	<b>Ø300mm</b>
<b>CR</b>	CHROM		<b>2085,00</b>

	<b>INDEKS E</b>	<b>C06657</b>	<b>Ø300mm</b>
<b>NO</b>	CZARNY MAT		<b>3220,00</b>

	<b>INDEKS F</b>	<b>SNO250</b>	<b>Ø250mm</b>
<b>CR</b>	CHROM		<b>1595,00</b>

**JO/JK015ZSC2..** ZESTAW NATRYSKOWY PODTYNKOWY

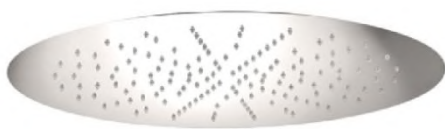

**SKŁAD ZESTAWU:**  
**DESZCZOWNICA:**  
 - ZSOF303 ø40CM  
 - A578EFCM44 ø44CM (CZARNY MAT) –DANIEL-  
 - ZESTAW 3W1 ZDUP094



<b>CR</b>	CHROM	<b>3790,00</b>
<b>NO</b>	CZARNY MAT	<b>4870,00</b>

**JO/JK015ZES01..** ZESTAW NATRYSKOWY Z DESZCZOWNICĄ SUFITOWĄ

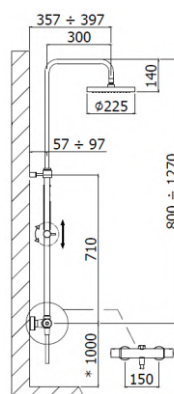

**INDEKS ZCOL638LIQ**

<b>CR</b>	CHROM	<b>2000,00</b>
<b>NO</b>	CZARNY MAT	<b>3300,00</b>

**ZCOL638LIQ..** KOLUMNA NATRYSKOWA TERMOSTATYCZNA ø225MM  
**ZCOL638KLIQ..** KOLUMNA NATRYSKOWA TERMOSTATYCZNA ø300MM

**INDEKS ZCOL638KLIQ**

<b>CR</b>	CHROM	<b>2600,00</b>
<b>NO</b>	CZARNY MAT	<b>3800,00</b>



**INDEKS 22704**

<b>CR</b>	CHROM	<b>520,00</b>
-----------	-------	---------------

**22704..** BIDETKA PODTYNKOWA KOMPLETNA PEONIA

**INDEKS ZDUP110**

<b>NO</b>	CZARNY MAT	<b>800,00</b>
-----------	------------	---------------





**LIG001..** BATERIA WANNOWA PODTYNKOWA ZESPOLONA

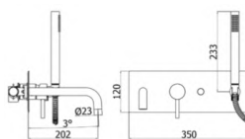

<b>CR</b>	CHROM	1960,00
<b>*BO</b>	BIAŁY MAT	2600,00
<b>NO</b>	CZARNY MAT	2600,00
<b>ST</b>	STAL SZCZOTKOWANA	3000,00
<b>MG</b>	GRAFITOWY	2810,00
<b>RMSP</b>	MIEDŹ SZCZOTKOWANA	3920,00
<b>*HG</b>	ZŁOTY BŁYSZCZĄCY	4900,00
<b>*HGSP</b>	ZŁOTY SZCZOTKOWANY	5300,00



**LIG004..** BATERIA UMYWALKOWA PODTYNKOWA L-128MM  
**LIG006..** BATERIA UMYWALKOWA PODTYNKOWA L-178MM  
**LIG007..** BATERIA UMYWALKOWA PODTYNKOWA L-248MM

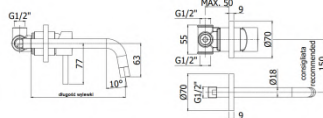

<b>CR</b>	CHROM	620,00
<b>BO</b>	BIAŁY MAT	800,00
<b>NO</b>	CZARNY MAT	800,00
<b>ST</b>	STAL SZCZOTKOWANA	930,00
<b>MG</b>	GRAFITOWY	910,00
<b>RMSP</b>	MIEDŹ SZCZOTKOWANA	1200,00
<b>HG</b>	ZŁOTY BŁYSZCZĄCY	1550,00
<b>*HGSP</b>	ZŁOTY SZCZOTKOWANY	1680,00



**LIG104..70** BATERIA UMYWALKOWA P/T ZINTEGROWANA L-128MM  
**LIG105..70** BATERIA UMYWALKOWA P/T ZINTEGROWANA L-178MM  
**LIG106..70** BATERIA UMYWALKOWA P/T ZINTEGROWANA L-248MM

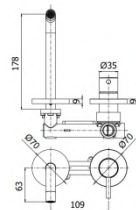

<b>CR</b>	CHROM	790,00
<b>*BO</b>	BIAŁY MAT	1030,00
<b>NO</b>	CZARNY MAT	1030,00
<b>ST</b>	STAL SZCZOTKOWANA	1200,00
<b>MG</b>	GRAFITOWY	1160,00
<b>RMSP</b>	MIEDŹ SZCZOTKOWANA	1600,00
<b>HG</b>	ZŁOTY BŁYSZCZĄCY	1980,00
<b>*HGSP</b>	ZŁOTY SZCZOTKOWANY	2150,00



**LIG010..** BATERIA PODTYNKOWA 1-DROŻNA

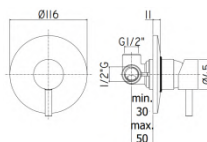

<b>CR</b>	CHROM	310,00
<b>*BO</b>	BIAŁY MAT	540,00
<b>NO</b>	CZARNY MAT	540,00
<b>ST</b>	STAL SZCZOTKOWANA	620,00
<b>*MG</b>	GRAFITOWY	590,00
<b>*RMSP</b>	MIEDŹ SZCZOTKOWANA	820,00
<b>*HG</b>	ZŁOTY BŁYSZCZĄCY	1000,00
<b>*HGSP</b>	ZŁOTY SZCZOTKOWANY	1100,00



**LIG010..70**

BATERIA PODTYNKOWA 1-DROŻNA

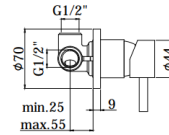

<b>CR</b>	CHROM	<b>400,00</b>
<b>BO</b>	BIAŁY MAT	<b>600,00</b>
<b>NO</b>	CZARNY MAT	<b>600,00</b>
<b>ST</b>	STAL SZCZOTKOWANA	<b>700,00</b>
<b>MG</b>	GRAFITOWY	<b>600,00</b>
<b>RMSP</b>	MIEDŹ SZCZOTKOWANA	<b>850,00</b>
<b>*HG</b>	ZŁOTY BŁYSZCZĄCY	<b>1200,00</b>
<b>*HGSP</b>	ZŁOTY SZCZOTKOWANY	<b>1350,00</b>



**LIG015..**

BATERIA PODTYNKOWA 2-DROŻNA

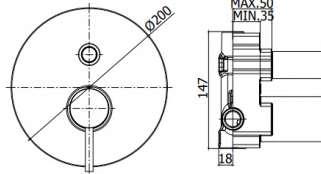

<b>CR</b>	CHROM	<b>680,00</b>
<b>BO</b>	BIAŁY MAT	<b>880,00</b>
<b>NO</b>	CZARNY MAT	<b>880,00</b>
<b>ST</b>	STAL SZCZOTKOWANA	<b>1050,00</b>
<b>MG</b>	GRAFITOWY	<b>1000,00</b>
<b>RMSP</b>	MIEDŹ SZCZOTKOWANA	<b>1450,00</b>
<b>HG</b>	ZŁOTY BŁYSZCZĄCY	<b>1700,00</b>
<b>*HGSP</b>	ZŁOTY SZCZOTKOWANY	<b>1850,00</b>



**LIG018..**

BATERIA PODTYNKOWA 2-DROŻNA Z PRZEŁĄCZNIKIEM MECHANICZNYM

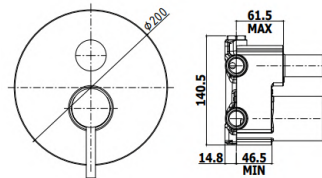

<b>CR</b>	CHROM	<b>1080,00</b>
<b>*BO</b>	BIAŁY MAT	<b>1390,00</b>
<b>NO</b>	CZARNY MAT	<b>1390,00</b>
<b>ST</b>	STAL SZCZOTKOWANA	<b>1600,00</b>
<b>MG</b>	GRAFITOWY	<b>1550,00</b>
<b>RMSP</b>	MIEDŹ SZCZOTKOWANA	<b>2200,00</b>
<b>HG</b>	ZŁOTY BŁYSZCZĄCY	<b>2700,00</b>
<b>*HGSP</b>	ZŁOTY SZCZOTKOWANY	<b>2900,00</b>

**LIG019..**

BATERIA PODTYNKOWA 3-DROŻNA Z PRZEŁĄCZNIKIEM MECHANICZNYM



**CPT013..**

BATERIA PODTYNKOWA **TERMOSAT** 1-DROŻNA (CPBOX)

**CPT018..**

BATERIA PODTYNKOWA **TERMOSAT** 2-DROŻNA (CPBOX)

**CPT019..**

BATERIA PODTYNKOWA **TERMOSAT** 3-DROŻNA (CPBOX)

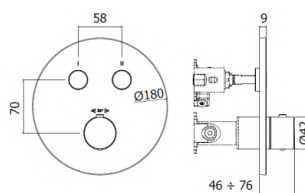

<b>CR</b>	CHROM	<b>2800,00</b>
<b>*BO</b>	BIAŁY MAT	<b>3700,00</b>
<b>NO</b>	CZARNY MAT	<b>3700,00</b>
<b>ST</b>	STAL SZCZOTKOWANA	<b>3900,00</b>
<b>*HG</b>	ZŁOTY BŁYSZCZĄCY	<b>4600,00</b>
<b>*HGSP</b>	ZŁOTY SZCZOTKOWANY	<b>5100,00</b>



**LIQ013..**

BATERIA PODTYNKOWA **TERMOSAT** 1-DROŻNA

**LIQ018..**

BATERIA PODTYNKOWA **TERMOSAT** 2-DROŻNA

**LIQ019..**

BATERIA PODTYNKOWA **TERMOSAT** 3-DROŻNA

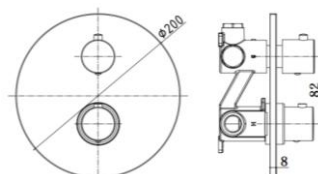

<b>CR</b>	CHROM	<b>1420,00</b>
<b>*BO</b>	BIAŁY MAT	<b>2000,00</b>
<b>NO</b>	CZARNY MAT	<b>2000,00</b>
<b>ST</b>	STAL SZCZOTKOWANA	<b>2200,00</b>
<b>*MG</b>	GRAFITOWY	<b>2000,00</b>
<b>*RMSP</b>	MIEDŹ SZCZOTKOWANA	<b>2750,00</b>
<b>*HG</b>	ZŁOTY BŁYSZCZĄCY	<b>3400,00</b>
<b>*HGSP</b>	ZŁOTY SZCZOTKOWANY	<b>3700,00</b>



**LIG022..** BATERIA WANNOWA ŚCIENNA (KORPUS)  
**LIG023..** BATERIA WANNOWA ŚCIENNA (KOMPLETNA)

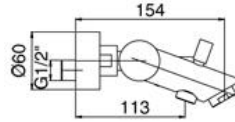

INDEKS LIG022		
<b>CR</b>	CHROM	1100,00
<b>*BO</b>	BIAŁY MAT	1440,00
<b>NO</b>	CZARNY MAT	1440,00
<b>ST</b>	STAL SZCZOTKOWANA	1640,00
<b>MG</b>	GRAFITOWY	1580,00
<b>RMSP</b>	MIEDŹ SZCZOTKOWANA	2200,00
<b>*HG</b>	ZŁOTY BŁYSZCZĄCY	2700,00
<b>*HGSP</b>	ZŁOTY SZCZOTKOWANY	3500,00

INDEKS LIG023		
<b>CR</b>	CHROM	1340,00
<b>*BO</b>	BIAŁY MAT	1730,00
<b>NO</b>	CZARNY MAT	1730,00
<b>ST</b>	STAL SZCZOTKOWANA	2000,00
<b>MG</b>	GRAFITOWY	1905,00
<b>RMSP</b>	MIEDŹ SZCZOTKOWANA	2700,00
<b>*HG</b>	ZŁOTY BŁYSZCZĄCY	3500,00
<b>*HGSP</b>	ZŁOTY SZCZOTKOWANY	3800,00



**LIQ022..** BATERIA WANNOWA ŚCIENNA TERMOŚAT (KORPUS)  
**LIQ023..** BATERIA WANNOWA ŚCIENNA TERMOSTATYCZNA (KOMPLETNA)

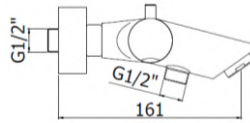

INDEKS LIQ022		
<b>CR</b>	CHROM	1300,00
<b>*BO</b>	BIAŁY MAT	1600,00
<b>NO</b>	CZARNY MAT	1600,00
<b>*ST</b>	STAL SZCZOTKOWANA	1850,00
<b>*MG</b>	GRAFITOWY	1600,00
<b>*RMSP</b>	MIEDŹ SZCZOTKOWANA	2200,00
<b>*HG</b>	ZŁOTY BŁYSZCZĄCY	2700,00
<b>*HGSP</b>	ZŁOTY SZCZOTKOWANY	2950,00

INDEKS LIQ023		
<b>CR</b>	CHROM	1600,00
<b>*BO</b>	BIAŁY MAT	2000,00
<b>NO</b>	CZARNY MAT	2000,00
<b>*ST</b>	STAL SZCZOTKOWANA	2400,00
<b>*MG</b>	GRAFITOWY	2000,00
<b>*RMSP</b>	MIEDŹ SZCZOTKOWANA	2800,00
<b>*HG</b>	ZŁOTY BŁYSZCZĄCY	3400,00
<b>*HGSP</b>	ZŁOTY SZCZOTKOWANY	3850,00



**LIG040..** BATERIA WANNOWA 3-OTWOROWA

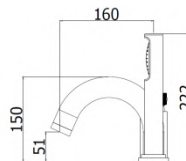

<b>CR</b>	CHROM	1500,00
<b>*BO</b>	BIAŁY MAT	2150,00
<b>NO</b>	CZARNY MAT	2150,00
<b>ST</b>	STAL SZCZOTKOWANA	2480,00
<b>MG</b>	GRAFITOWY	2350,00
<b>RMSP</b>	MIEDŹ SZCZOTKOWANA	3300,00
<b>*HG</b>	ZŁOTY BŁYSZCZĄCY	4000,00
<b>*HGSP</b>	ZŁOTY SZCZOTKOWANY	4300,00



**LIG071..** BATERIA UMYWALKOWA STOJĄCA (BEZ KORKA)  
**LIG071K..** BATERIA UMYWALKOWA STOJĄCA (KOREK CLICK CLACK)

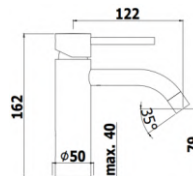

INDEKS LIG071		
<b>CR</b>	CHROM	555,00
<b>BO</b>	BIAŁY MAT	720,00
<b>NO</b>	CZARNY MAT	720,00
<b>ST</b>	STAL SZCZOTKOWANA	835,00
<b>MG</b>	GRAFITOWY	780,00
<b>RMSP</b>	MIEDŹ SZCZOTKOWANA	1100,00
<b>HG</b>	ZŁOTY BŁYSZCZĄCY	1350,00
<b>*HGSP</b>	ZŁOTY SZCZOTKOWANY	1450,00

INDEKS LIG071K		
<b>CR</b>	CHROM	635,00
<b>BO</b>	BIAŁY MAT	885,00
<b>NO</b>	CZARNY MAT	840,00
<b>ST</b>	STAL SZCZOTKOWANA	1085,00
<b>MG</b>	GRAFITOWY	985,00
<b>RMSP</b>	MIEDŹ SZCZOTKOWANA	1520,00
<b>HG</b>	ZŁOTY BŁYSZCZĄCY	1800,00
<b>*HGSP</b>	ZŁOTY SZCZOTKOWANY	1900,00



**LIGX071..** BATERIA UMYWALKOWA STOJĄCA (BEZ KORKA)  
**LIGX071K..** BATERIA UMYWALKOWA STOJĄCA (KOREK CLICK CLACK)

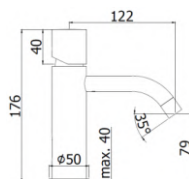

	<b>INDEKS LIGX071</b>	
<b>CR</b>	CHROM	<b>610,00</b>
<b>*NO</b>	CZARNY MAT	<b>840,00</b>
<b>*ST</b>	STAL SZCZOTKOWANA	<b>960,00</b>

	<b>INDEKS LIGX071K</b>	
<b>CR</b>	CHROM	<b>690,00</b>
<b>*NO</b>	CZARNY MAT	<b>960,00</b>
<b>*ST</b>	STAL SZCZOTKOWANA	<b>1200,00</b>



**LIG078..** BATERIA UMYWALKOWA STOJĄCA (BEZ KORKA)  
**LIG078K..** BATERIA UMYWALKOWA STOJĄCA (KOREK CLICK CLACK)

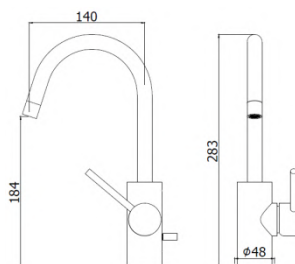

	<b>INDEKS LIG078</b>	
<b>CR</b>	CHROM	<b>725,00</b>
<b>*BO</b>	BIAŁY MAT	<b>950,00</b>
<b>NO</b>	CZARNY MAT	<b>950,00</b>
<b>*ST</b>	STAL SZCZOTKOWANA	<b>1090,00</b>
<b>MG</b>	GRAFITOWY	<b>1050,00</b>
<b>RMSP</b>	MIEDŹ SZCZOTKOWANA	<b>1450,00</b>
<b>HG</b>	ZŁOTY BŁYSZCZĄCY	<b>1800,00</b>
<b>*HGSP</b>	ZŁOTY SZCZOTKOWANY	<b>1960,00</b>

	<b>INDEKS LIG078K</b>	
<b>CR</b>	CHROM	<b>805,00</b>
<b>*BO</b>	BIAŁY MAT	<b>1070,00</b>
<b>NO</b>	CZARNY MAT	<b>1070,00</b>
<b>HG</b>	ZŁOTY BŁYSZCZĄCY	<b>2250,00</b>



**LIG081..** BATERIA UMYWALKOWA WYSOKA (BEZ KORKA)  
**LIG081K..** BATERIA UMYWALKOWA WYSOKA (KOREK CLICK CLACK)

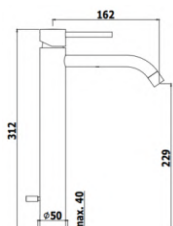

	<b>INDEKS LIG081</b>	
<b>CR</b>	CHROM	<b>925,00</b>
<b>BO</b>	BIAŁY MAT	<b>1200,00</b>
<b>NO</b>	CZARNY MAT	<b>1200,00</b>
<b>ST</b>	STAL SZCZOTKOWANA	<b>1390,00</b>
<b>MG</b>	GRAFITOWY	<b>1340,00</b>
<b>RMSP</b>	MIEDŹ SZCZOTKOWANA	<b>1850,00</b>
<b>HG</b>	ZŁOTY BŁYSZCZĄCY	<b>2250,00</b>
<b>*HGSP</b>	ZŁOTY SZCZOTKOWANY	<b>2450,00</b>

	<b>INDEKS LIG081K</b>	
<b>CR</b>	CHROM	<b>1005,00</b>
<b>BO</b>	BIAŁY MAT	<b>1360,00</b>
<b>NO</b>	CZARNY MAT	<b>1320,00</b>
<b>ST</b>	STAL SZCZOTKOWANA	<b>1630,00</b>
<b>MG</b>	GRAFITOWY	<b>1555,00</b>
<b>RMSP</b>	MIEDŹ SZCZOTKOWANA	<b>2190,00</b>
<b>HG</b>	ZŁOTY BŁYSZCZĄCY	<b>2650,00</b>
<b>*HGSP</b>	ZŁOTY SZCZOTKOWANY	<b>2900,00</b>



**LIGX081..** BATERIA UMYWALKOWA WYSOKA (BEZ KORKA)  
**LIGX081K..** BATERIA UMYWALKOWA WYSOKA (KOREK CLICK CLACK)

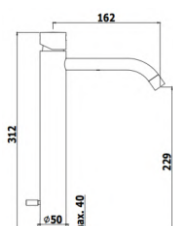

	<b>INDEKS LIGX081</b>	
<b>CR</b>	CHROM	<b>1010,00</b>
<b>*NO</b>	CZARNY MAT	<b>1400,00</b>
<b>*ST</b>	STAL SZCZOTKOWANA	<b>1600,00</b>

	<b>INDEKS LIGX081K</b>	
<b>CR</b>	CHROM	<b>1090,00</b>
<b>*NO</b>	CZARNY MAT	<b>1520,00</b>
<b>*ST</b>	STAL SZCZOTKOWANA	<b>1840,00</b>



**LIG105..** BATERIA UMYWALKOWA PODTYNKOWA L-178MM  
**LIG106..** BATERIA UMYWALKOWA PODTYNKOWA L-248MM

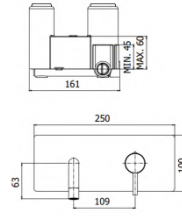

<b>CR</b>	CHROM	1010,00
<b>*BO</b>	BIAŁY MAT	1320,00
<b>NO</b>	CZARNY MAT	1320,00
<b>*ST</b>	STAL SZCZOTKOWANA	1520,00
<b>*MG</b>	GRAFITOWY	1320,00
<b>*RMSP</b>	MIEDŹ SZCZOTKOWANA	2000,00
<b>*HG</b>	ZŁOTY BŁYSZCZĄCY	2510,00
<b>*HGSP</b>	ZŁOTY SZCZOTKOWANY	2750,00



**LIG131..** BATERIA BIDETOWA STOJĄCA (BEZ KORKA)  
**LIG131K..** BATERIA BIDETOWA STOJĄCA (KOREK CLICK CLACK)

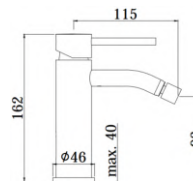

**INDEKS LIG131**

<b>CR</b>	CHROM	555,00
<b>*BO</b>	BIAŁY MAT	720,00
<b>NO</b>	CZARNY MAT	720,00
<b>ST</b>	STAL SZCZOTKOWANA	835,00
<b>MG</b>	GRAFITOWY	780,00
<b>RMSP</b>	MIEDŹ SZCZOTKOWANA	1100,00
<b>HG</b>	ZŁOTY BŁYSZCZĄCY	1350,00
<b>*HGSP</b>	ZŁOTY SZCZOTKOWANY	1450,00

**INDEKS LIG131K**

<b>CR</b>	CHROM	635,00
<b>*BO</b>	BIAŁY MAT	885,00
<b>NO</b>	CZARNY MAT	840,00
<b>ST</b>	STAL SZCZOTKOWANA	1085,00
<b>MG</b>	GRAFITOWY	985,00
<b>RMSP</b>	MIEDŹ SZCZOTKOWANA	1520,00
<b>HG</b>	ZŁOTY BŁYSZCZĄCY	1800,00
<b>*HGSP</b>	ZŁOTY SZCZOTKOWANY	1900,00



**LIGX131..** BATERIA BIDETOWA STOJĄCA (BEZ KORKA)  
**LIGX131K..** BATERIA BIDETOWA STOJĄCA (KOREK CLICK CLACK)

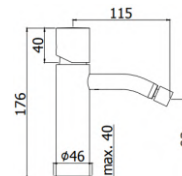

**INDEKS LIGX131**

<b>CR</b>	CHROM	610,00
<b>*NO</b>	CZARNY MAT	840,00
<b>*ST</b>	STAL SZCZOTKOWANA	960,00

**INDEKS LIGX131K**

<b>CR</b>	CHROM	690,00
<b>*NO</b>	CZARNY MAT	960,00
<b>*ST</b>	STAL SZCZOTKOWANA	1200,00



**LIG168..** BATERIA NATRYSKOWA ŚCIENNA (KORPUS)  
**LIG168D..** BATERIA NATRYSKOWA ŚCIENNA (KOMPLETNA)

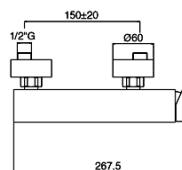

**INDEKS LIG168**

<b>CR</b>	CHROM	880,00
<b>*BO</b>	BIAŁY MAT	1140,00
<b>NO</b>	CZARNY MAT	1140,00
<b>*ST</b>	STAL SZCZOTKOWANA	1350,00
<b>*MG</b>	GRAFITOWY	1280,00
<b>*RMSP</b>	MIEDŹ SZCZOTKOWANA	1760,00
<b>*HG</b>	ZŁOTY BŁYSZCZĄCY	2200,00
<b>*HGSP</b>	ZŁOTY SZCZOTKOWANY	2400,00

**INDEKS LIG168D**

<b>CR</b>	CHROM	1160,00
<b>*BO</b>	BIAŁY MAT	1500,00
<b>NO</b>	CZARNY MAT	1500,00
<b>*ST</b>	STAL SZCZOTKOWANA	1730,00
<b>*MG</b>	GRAFITOWY	1660,00
<b>*RMSP</b>	MIEDŹ SZCZOTKOWANA	2320,00
<b>*HG</b>	ZŁOTY BŁYSZCZĄCY	3050,00
<b>*HGSP</b>	ZŁOTY SZCZOTKOWANY	3300,00

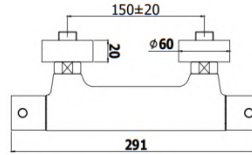

<b>CR</b>	CHROM	<b>930,00</b>
<b>*BO</b>	BIAŁY MAT	<b>1220,00</b>
<b>NO</b>	CZARNY MAT	<b>1220,00</b>
<b>*ST</b>	STAL SZCZOTKOWANA	<b>1400,00</b>
<b>*MG</b>	GRAFITOWY	<b>1220,00</b>
<b>*RMSP</b>	MIEDŹ SZCZOTKOWANA	<b>1700,00</b>
<b>*HG</b>	ZŁOTY BŁYSZCZĄCY	<b>2050,00</b>
<b>*HGSP</b>	ZŁOTY SZCZOTKOWANY	<b>2200,00</b>

**LIQ168..** BATERIA NATRYSKOWA **TERMOSTAT** ŚCIENNA (KORPUS)

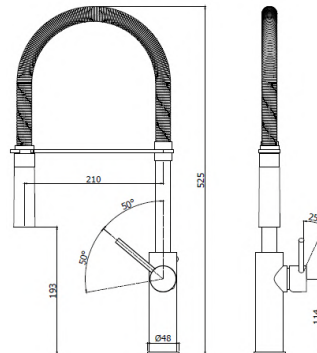

**INDEKS LIG179**

<b>CR</b>	CHROM	<b>1320,00</b>
-----------	-------	----------------

**INDEKS LIG179..NO**

<b>CR</b>	CHROM	<b>1390,00</b>
<b>NO</b>	CZARNY MAT	<b>1800,00</b>
<b>ST</b>	STAL SZCZOTKOWANA	<b>2080,00</b>
<b>MG</b>	GRAFITOWY	<b>1890,00</b>
<b>RMSP</b>	MIEDŹ SZCZOTKOWANA	<b>2800,00</b>
<b>HG</b>	ZŁOTY BŁYSZCZĄCY	<b>3400,00</b>
<b>HGSP</b>	ZŁOTY SZCZOTKOWANY	<b>3750,00</b>

**LIG179..** BATERIA ZLEWOZMYWAKOWA STOJĄCA ZE **SREBRNYM** WĘŻEM

**LIG179..NO** BATERIA ZLEWOZMYWAKOWA STOJĄCA Z **CZARNYM** WĘŻEM

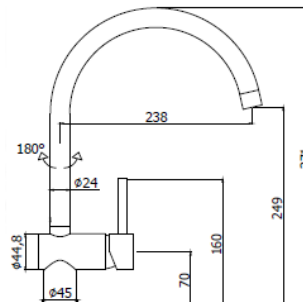

<b>CR</b>	CHROM	<b>740,00</b>
<b>*BO</b>	BIAŁY MAT	<b>955,00</b>
<b>NO</b>	CZARNY MAT	<b>955,00</b>
<b>*ST</b>	STAL SZCZOTKOWANA	<b>1100,00</b>
<b>MG</b>	GRAFITOWY	<b>1050,00</b>
<b>RMSP</b>	MIEDŹ SZCZOTKOWANA	<b>1500,00</b>
<b>HG</b>	ZŁOTY BŁYSZCZĄCY	<b>1800,00</b>
<b>*HGSP</b>	ZŁOTY SZCZOTKOWANY	<b>1950,00</b>

**LIG280..** BATERIA ZLEWOZMYWAKOWA STOJĄCA

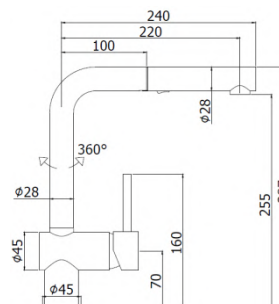

<b>CR</b>	CHROM	<b>900,00</b>
<b>BO</b>	BIAŁY MAT	<b>1170,00</b>
<b>NO</b>	CZARNY MAT	<b>1170,00</b>
<b>ST</b>	STAL SZCZOTKOWANA	<b>1350,00</b>
<b>MG</b>	GRAFITOWY	<b>1290,00</b>
<b>RMSP</b>	MIEDŹ SZCZOTKOWANA	<b>1800,00</b>
<b>HG</b>	ZŁOTY BŁYSZCZĄCY	<b>2200,00</b>
<b>HGSP</b>	ZŁOTY SZCZOTKOWANY	<b>2380,00</b>

**LIG285..** BATERIA ZLEWOZMYWAKOWA STOJĄCA Z WĘŻEM OPERACYJNYM

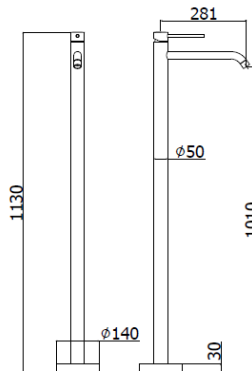
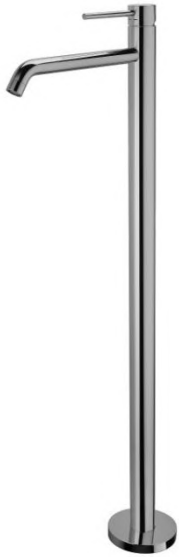

**LIG031..**

BATERIA UMYWALKOWA WOLNOSTOJĄCA (KOMPLETNA)

<b>CR</b>	CHROM	<b>6000,00</b>
<b>NO</b>	CZARNY MAT	<b>7400,00</b>

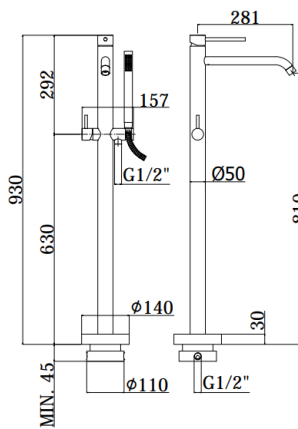

**LIG032..**

BATERIA WANNOWA WOLNOSTOJĄCA (KOMPLETNA)



<b>CR</b>	CHROM	<b>6400,00</b>
<b>*BO</b>	BIAŁY MAT	<b>8000,00</b>
<b>NO</b>	CZARNY MAT	<b>8000,00</b>
<b>ST</b>	STAL SZCZOTKOWANA	<b>9100,00</b>
<b>*MG</b>	GRAFITOWY	<b>8000,00</b>
<b>*RMSP</b>	MIEDŹ SZCZOTKOWANA	<b>11700,00</b>
<b>*HG</b>	ZŁOTY BŁYSZCZĄCY	<b>15000,00</b>
<b>*HGSP</b>	ZŁOTY SZCZOTKOWANY	<b>15500,00</b>

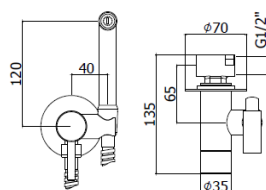

**22704..**

BATERIA BIDETOWA PODTYNKOWA SANY

-AP-

**ZDUP110..**

BATERIA BIDETOWA PODTYNKOWA SANY

-PAFFONI-



**INDEKS 22704**

<b>CR</b>	CHROM	<b>520,00</b>
-----------	-------	---------------

**INDEKS ZDUP110**

<b>BO</b>	BIAŁY MAT	<b>800,00</b>
<b>NO</b>	CZARNY MAT	<b>800,00</b>
<b>ST</b>	STAL SZCZOTKOWANA	<b>950,00</b>
<b>BR</b>	STARE ZŁOTO	<b>1050,00</b>
<b>HG</b>	ZŁOTY BŁYSZCZĄCY	<b>1200,00</b>
<b>*HGSP</b>	ZŁOTY SZCZOTKOWANY	<b>1350,00</b>



SKŁAD ZESTAWU:  
- ZESTAW 3w1 ZDUP094  
- WYLEWKA ŚCIENNA L-175MM

**LIG010..70ZWW**

ZESTAW WANNOWY PODTYNKOWY



<b>CR</b>	CHROM	1500,00
<b>BO</b>	BIAŁY MAT	2390,00
<b>NO</b>	CZARNY MAT	2390,00
<b>ST</b>	STAL SZCZOTKOWANA	2770,00
<b>MG</b>	GRAFITOWY	2390,00
<b>RMSP</b>	MIEDŹ SZCZOTKOWANA	3600,00
<b>HG</b>	ZŁOTY BŁYSZCZĄCY	4320,00
<b>*HGSP</b>	ZŁOTY SZCZOTKOWANY	4740,00



SKŁAD ZESTAWU:  
- ZESTAW 3w1 ZDUP094  
- WYLEWKA ŚCIENNA L-175MM

**LIG015ZWW..**

ZESTAW WANNOWY PODTYNKOWY



<b>CR</b>	CHROM	1380,00
<b>BO</b>	BIAŁY MAT	1890,00
<b>NO</b>	CZARNY MAT	1890,00
<b>ST</b>	STAL SZCZOTKOWANA	2280,00
<b>MG</b>	GRAFITOWY	1960,00
<b>RMSP</b>	MIEDŹ SZCZOTKOWANA	3100,00
<b>HG</b>	ZŁOTY BŁYSZCZĄCY	3620,00
<b>*HGSP</b>	ZŁOTY SZCZOTKOWANY	3890,00



SKŁAD ZESTAWU:  
- ZESTAW 3w1 ZDUP094  
- WYLEWKA ŚCIENNA L-175MM

**LIG018ZWW..**

ZESTAW WANNOWY PODTYNKOWY



<b>CR</b>	CHROM	1900,00
<b>*BO</b>	BIAŁY MAT	2400,00
<b>NO</b>	CZARNY MAT	2400,00
<b>ST</b>	STAL SZCZOTKOWANA	2830,00
<b>MG</b>	GRAFITOWY	2540,00
<b>RMSP</b>	MIEDŹ SZCZOTKOWANA	3860,00
<b>HG</b>	ZŁOTY BŁYSZCZĄCY	4720,00
<b>*HGSP</b>	ZŁOTY SZCZOTKOWANY	4990,00



SKŁAD ZESTAWU:  
- DESZCZOWNICA:  
(INDEKS A) ZSOF074 **Ø225MM**  
(INDEKS C) ZSOF079 **Ø300MM**  
(INDEKS E) C06657 **Ø300MM** -EMMEVI-  
- RAMIĘ ŚCIENNE L-400MM  
- ZESTAW Z RĄCZKĄ I WĘŻEM ZDUP094  
- PÓLSYFON Z NAPEŁNIENIEM PRZEZ PRZELEW D6 -CRS-

**LIG019ZWSCSU3..**

ZESTAW WANNOWY P/T Z NAPEŁNIENIEM PRZEZ PRZELEW



<b>INDEKS A ZSOF074 Ø225mm</b>		
<b>CR</b>	CHROM	2685,00
<b>*BO</b>	BIAŁY MAT	3760,00
<b>NO</b>	CZARNY MAT	3760,00
<b>ST</b>	STAL SZCZOTKOWANA	4250,00
<b>HG</b>	ZŁOTY BŁYSZCZĄCY	6430,00

<b>INDEKS C ZSOF079 Ø300mm</b>		
<b>CR</b>	CHROM	3055,00
<b>NO</b>	CZARNY MAT	4400,00
<b>ST</b>	STAL SZCZOTKOWANA	5050,00
<b>HG</b>	ZŁOTY BŁYSZCZĄCY	7680,00

<b>INDEKS E C06657 Ø300mm</b>		
<b>NO</b>	CZARNY MAT	5150,00





**SKŁAD ZESTAWU:**  
 - DESZCZOWNICA:  
 (INDEKS A) ZSOF074  $\varnothing$ 225MM  
 (INDEKS C) ZSOF079  $\varnothing$ 300MM  
 (INDEKS E) C06657  $\varnothing$ 300MM -EMMEVI-  
 - RAMIĘ ŚCIENNE L-400MM  
 - ZESTAW 3W1 ZDUP094  
 - WYLEWKA ŚCIENNA L-175MM

**LIG019ZSCW3..** ZESTAW WANNOWY PODTYNKOWY



**INDEKS A ZSOF074  $\varnothing$ 225mm**

<b>CR</b>	CHROM	<b>2515,00</b>
<b>*BO</b>	BIAŁY MAT	<b>3400,00</b>
<b>NO</b>	CZARNY MAT	<b>3400,00</b>
<b>ST</b>	STAL SZCZOTKOWANA	<b>4080,00</b>
<b>MG</b>	GRAFITOWY	<b>3550,00</b>
<b>RMSP</b>	MIEDŹ SZCZOTKOWANA	<b>5830,00</b>
<b>HG</b>	ZŁOTY BŁYSZCZĄCY	<b>6520,00</b>
<b>*HGSP</b>	ZŁOTY SZCZOTKOWANY	<b>6990,00</b>

**INDEKS C ZSOF079  $\varnothing$ 300mm**

<b>CR</b>	CHROM	<b>2885,00</b>
<b>NO</b>	CZARNY MAT	<b>4140,00</b>
<b>ST</b>	STAL SZCZOTKOWANA	<b>4780,00</b>
<b>MG</b>	GRAFITOWY	<b>4290,00</b>
<b>RMSP</b>	MIEDŹ SZCZOTKOWANA	<b>7210,00</b>
<b>HG</b>	ZŁOTY BŁYSZCZĄCY	<b>7770,00</b>
<b>*HGSP</b>	ZŁOTY SZCZOTKOWANY	<b>8340,00</b>

**INDEKS E C06657  $\varnothing$ 300mm**

<b>NO</b>	CZARNY MAT	<b>4240,00</b>
-----------	------------	----------------



**SKŁAD ZESTAWU:**  
 - DESZCZOWNICA:  
 (INDEKS A) ZSOF074  $\varnothing$ 225MM  
 (INDEKS C) ZSOF079  $\varnothing$ 300MM  
 (INDEKS E) C06657  $\varnothing$ 300MM -EMMEVI-  
 - RAMIĘ ŚCIENNE L-400MM  
 - ZESTAW 3W1 ZDUP094

**LIG010..70ZSC3** ZESTAW NATRYSKOWY PODTYNKOWY



**INDEKS A ZSOF074  $\varnothing$ 225mm**

<b>CR</b>	CHROM	<b>1845,00</b>
<b>BO</b>	BIAŁY MAT	<b>3000,00</b>
<b>NO</b>	CZARNY MAT	<b>3000,00</b>
<b>ST</b>	STAL SZCZOTKOWANA	<b>3490,00</b>
<b>MG</b>	GRAFITOWY	<b>3000,00</b>
<b>RMSP</b>	MIEDŹ SZCZOTKOWANA	<b>4800,00</b>
<b>HG</b>	ZŁOTY BŁYSZCZĄCY	<b>5330,00</b>
<b>*HGSP</b>	ZŁOTY SZCZOTKOWANY	<b>5850,00</b>

**INDEKS C ZSOF079  $\varnothing$ 300mm**

<b>CR</b>	CHROM	<b>2215,00</b>
<b>NO</b>	CZARNY MAT	<b>3740,00</b>
<b>ST</b>	STAL SZCZOTKOWANA	<b>4190,00</b>
<b>MG</b>	GRAFITOWY	<b>3740,00</b>
<b>RMSP</b>	MIEDŹ SZCZOTKOWANA	<b>6100,00</b>
<b>HG</b>	ZŁOTY BŁYSZCZĄCY	<b>6580,00</b>
<b>*HGSP</b>	ZŁOTY SZCZOTKOWANY	<b>7200,00</b>

**INDEKS E C06657  $\varnothing$ 300mm**

<b>NO</b>	CZARNY MAT	<b>3840,00</b>
-----------	------------	----------------



**SKŁAD ZESTAWU:**

- DESZCZOWNICA:  
(INDEKS A) ZSOF074 **Ø225MM**  
(INDEKS C) ZSOF079 **Ø300MM**  
(INDEKS E) C06657 **Ø300MM** -EMMEVI-  
(INDEKS F) SNO250 **Ø250MM**, WERSJA **SLIM** -AP-
- RAMIĘ ŚCIENNE **L-400MM**
- ZESTAW 3W1 ZDUP094

**LIG015ZSC2..** ZESTAW NATRYSKOWY PODTYNKOWY



**INDEKS A ZSOF074 Ø225mm**

<b>CR</b>	CHROM	<b>1685,00</b>
<b>BO</b>	BIAŁY MAT	<b>2500,00</b>
<b>NO</b>	CZARNY MAT	<b>2500,00</b>
<b>ST</b>	STAL SZCZOTKOWANA	<b>3000,00</b>
<b>MG</b>	GRAFITOWY	<b>2570,00</b>
<b>RMSP</b>	MIEDŹ SZCZOTKOWANA	<b>4550,00</b>
<b>HG</b>	ZŁOTY BŁYSZCZĄCY	<b>4630,00</b>
<b>*HGSP</b>	ZŁOTY SZCZOTKOWANY	<b>5000,00</b>

**INDEKS C ZSOF079 Ø300mm**

<b>CR</b>	CHROM	<b>2065,00</b>
<b>NO</b>	CZARNY MAT	<b>3210,00</b>
<b>ST</b>	STAL SZCZOTKOWANA	<b>3700,00</b>
<b>MG</b>	GRAFITOWY	<b>3310,00</b>
<b>RMSP</b>	MIEDŹ SZCZOTKOWANA	<b>5900,00</b>
<b>HG</b>	ZŁOTY BŁYSZCZĄCY	<b>5880,00</b>
<b>*HGSP</b>	ZŁOTY SZCZOTKOWANY	<b>6350,00</b>

**INDEKS E C06657 Ø300mm**

<b>NO</b>	CZARNY MAT	<b>3310,00</b>
-----------	------------	----------------

**INDEKS F SNO250 Ø250mm**

<b>CR</b>	CHROM	<b>1585,00</b>
-----------	-------	----------------



**SKŁAD ZESTAWU:**

- DESZCZOWNICA:  
(INDEKS A) ZSOF074 **Ø225MM**  
(INDEKS E) C06657 **Ø300MM** -EMMEVI-  
(INDEKS F) SNO250 **Ø250MM**, WERSJA **SLIM** -AP-
- RAMIĘ ŚCIENNE **L-400MM**
- ZESTAW 3W1 ZDUP094

**LIG018ZSC2..** ZESTAW NATRYSKOWY PODTYNKOWY



**INDEKS A ZSOF074 Ø225mm**

<b>CR</b>	CHROM	<b>2205,00</b>
<b>*BO</b>	BIAŁY MAT	<b>3000,00</b>
<b>NO</b>	CZARNY MAT	<b>3000,00</b>
<b>ST</b>	STAL SZCZOTKOWANA	<b>3550,00</b>
<b>MG</b>	GRAFITOWY	<b>3150,00</b>
<b>RMSP</b>	MIEDŹ SZCZOTKOWANA	<b>5300,00</b>
<b>HG</b>	ZŁOTY BŁYSZCZĄCY	<b>5630,00</b>
<b>*HGSP</b>	ZŁOTY SZCZOTKOWANY	<b>6050,00</b>

**INDEKS C ZSOF079 Ø300mm**

<b>CR</b>	CHROM	<b>2575,00</b>
<b>NO</b>	CZARNY MAT	<b>3740,00</b>
<b>ST</b>	STAL SZCZOTKOWANA	<b>4250,00</b>
<b>MG</b>	GRAFITOWY	<b>3890,00</b>
<b>RMSP</b>	MIEDŹ SZCZOTKOWANA	<b>6500,00</b>
<b>HG</b>	ZŁOTY BŁYSZCZĄCY	<b>6880,00</b>
<b>*HGSP</b>	ZŁOTY SZCZOTKOWANY	<b>7400,00</b>

**INDEKS E C06657 Ø300mm**

<b>NO</b>	CZARNY MAT	<b>3840,00</b>
-----------	------------	----------------

**INDEKS F SNO250 Ø250mm**

<b>CR</b>	CHROM	<b>2095,00</b>
-----------	-------	----------------



**SKŁAD ZESTAWU:**

- DESZCZOWNICA:  
(INDEKS A) ZSOF074 **Ø225MM**  
(INDEKS C) ZSOF079 **Ø300MM**  
(INDEKS E) C06657 **Ø300MM** -EMMEVI-  
(INDEKS F) SNO250 **Ø250MM**, WERSJA **SLIM** -AP-
- RAMIĘ ŚCIENNE **L-400MM**
- ZESTAW NATRYSKOWY ZSAL135
- PRZYŁĄCZE KĄTOWE ZACC130



**INDEKS A ZSOF074 Ø225mm**

<b>CR</b>	CHROM	<b>2490,00</b>
<b>*BO</b>	BIAŁY MAT	<b>3300,00</b>
<b>NO</b>	CZARNY MAT	<b>3300,00</b>
<b>ST</b>	STAL SZCZOTKOWANA	<b>3915,00</b>
<b>MG</b>	GRAFITOWY	<b>3555,00</b>
<b>RMSP</b>	MIEDŹ SZCZOTKOWANA	<b>5200,00</b>
<b>HG</b>	ZŁOTY BŁYSZCZĄCY	<b>5400,00</b>
<b>*HGSP</b>	ZŁOTY SZCZOTKOWANY	<b>5850,00</b>

**INDEKS C ZSOF079 Ø300mm**

<b>CR</b>	CHROM	<b>2780,00</b>
<b>NO</b>	CZARNY MAT	<b>4045,00</b>
<b>ST</b>	STAL SZCZOTKOWANA	<b>4615,00</b>
<b>MG</b>	GRAFITOWY	<b>4295,00</b>
<b>RMSP</b>	MIEDŹ SZCZOTKOWANA	<b>6200,00</b>
<b>HG</b>	ZŁOTY BŁYSZCZĄCY	<b>6650,00</b>
<b>*HGSP</b>	ZŁOTY SZCZOTKOWANY	<b>7200,00</b>

**INDEKS E C06657 Ø300mm**

<b>NO</b>	CZARNY MAT	<b>4145,00</b>
-----------	------------	----------------

**INDEKS F SNO250 Ø250mm**

<b>CR</b>	CHROM	<b>2470,00</b>
-----------	-------	----------------

**LIG018ZN5..** ZESTAW NATRYSKOWY PODTYNKOWY

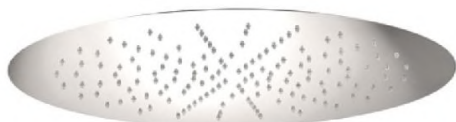

**SKŁAD ZESTAWU:**

- DESZCZOWNICA:  
- ZSOF303 **Ø400MM**  
- A578EFCM44 **Ø440MM** (CZARNY MAT)-DANIEL-  
- ZESTAW 3W1 ZDUP094



<b>CR</b>	CHROM	<b>4100,00</b>
<b>NO</b>	CZARNY MAT	<b>5400,00</b>

**LIG018ZES01..** ZESTAW NATRYSKOWY Z DESZCZOWNICĄ SUFITOWĄ



**INDEKS A ZSOF074 Ø225mm**

<b>CR</b>	CHROM	<b>2425,00</b>
<b>*BO</b>	BIAŁY MAT	<b>3500,00</b>
<b>NO</b>	CZARNY MAT	<b>3500,00</b>
<b>ST</b>	STAL SZCZOTKOWANA	<b>4150,00</b>
<b>MG</b>	GRAFITOWY	<b>3650,00</b>
<b>RMSP</b>	MIEDŹ SZCZOTKOWANA	<b>6000,00</b>
<b>HG</b>	ZŁOTY BŁYSZCZĄCY	<b>6330,00</b>
<b>*HGSP</b>	ZŁOTY SZCZOTKOWANY	<b>6850,00</b>



**SKŁAD ZESTAWU:**  
 - DESZCZOWNICA:  
 (INDEKS A) ZSOF074 **Ø225mm**  
 (INDEKS C) ZSOF079 **Ø300mm**  
 (INDEKS E) C06657 **Ø300mm** -EMMEVI-  
 (INDEKS F) SNO250 **Ø250mm**, WERSJA SLIM -AP-  
 - RAMIĘ ŚCIENNE L-400MM  
 - ZESTAW 3W1 ZDUP094

**INDEKS C ZSOF079 Ø300mm**

<b>CR</b>	CHROM	<b>2575,00</b>
<b>NO</b>	CZARNY MAT	<b>4340,00</b>
<b>ST</b>	STAL SZCZOTKOWANA	<b>4850,00</b>
<b>MG</b>	GRAFITOWY	<b>4340,00</b>
<b>RMSP</b>	MIEDŹ SZCZOTKOWANA	<b>6950,00</b>
<b>HG</b>	ZŁOTY BŁYSZCZĄCY	<b>7580,00</b>
<b>*HGSP</b>	ZŁOTY SZCZOTKOWANY	<b>8200,00</b>

**INDEKS E C06657 Ø300mm**

<b>NO</b>	CZARNY MAT	<b>4440,00</b>
-----------	------------	----------------

**INDEKS F SNO250 Ø250mm**

<b>CR</b>	CHROM	<b>2415,00</b>
-----------	-------	----------------

**LIQ018ZSC2..** ZESTAW NATRYSKOWY P/T TERMOSTATYCZNY



**SKŁAD ZESTAWU:**  
 DESZCZOWNICA:  
 - ZSOF303 **Ø400mm**  
 - ZESTAW 3W1 ZDUP094



**CR CHROM 4600,00**

**LIQ018ZES01..** ZESTAW NATRYSKOWY Z DESZCZOWNICĄ SUFITOWĄ

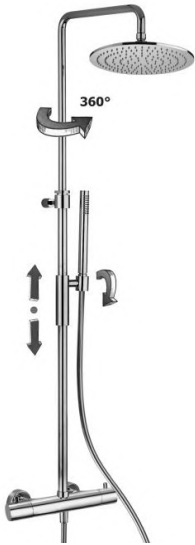

**ZCOL646..** KOLUMNA NATRYSKOWA TERMOSTATYCZNA **∅225MM**  
**ZCOL646K..** KOLUMNA NATRYSKOWA TERMOSTATYCZNA **∅300MM**  
**ZCOL646X..** KOLUMNA NATRYSKOWA TERMOSTATYCZNA **∅250MM** -AP-

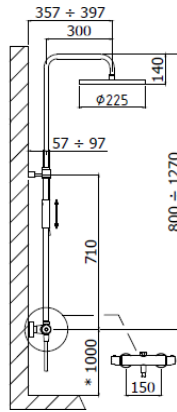

INDEKS **ZCOL646**

<b>CR</b>	CHROM	<b>2600,00</b>
<b>ST</b>	STAL SZCZOTKOWANA	<b>4400,00</b>

INDEKS **ZCOL646K**

<b>CR</b>	CHROM	<b>2750,00</b>
<b>ST</b>	STAL SZCZOTKOWANA	<b>5100,00</b>
<b>*RMSP</b>	MIEDŹ SZCZOTKOWANA	<b>5700,00</b>
<b>*HG</b>	ZŁOTY BŁYSZCZĄCY	<b>5300,00</b>
<b>*HGSP</b>	ZŁOTY SZCZOTKOWANY	<b>5700,00</b>

INDEKS **ZCOL646X**

<b>CR</b>	CHROM	<b>2300,00</b>
-----------	-------	----------------



**ZCOL638LIQ..** KOLUMNA NATRYSKOWA TERMOSTATYCZNA **∅225MM**  
**ZCOL638KLIQ..** KOLUMNA NATRYSKOWA TERMOSTATYCZNA **∅300MM**

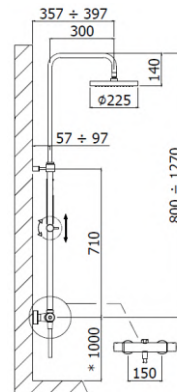

INDEKS **ZCOL638LIQ**

<b>CR</b>	CHROM	<b>2000,00</b>
<b>*BO</b>	BIAŁY MAT	<b>3300,00</b>
<b>NO</b>	CZARNY MAT	<b>3300,00</b>
<b>*MG</b>	GRAFITOWY	<b>3450,00</b>

INDEKS **ZCOL638KLIQ**

<b>CR</b>	CHROM	<b>2600,00</b>
<b>NO</b>	CZARNY MAT	<b>3800,00</b>
<b>MG</b>	GRAFITOWY	<b>4100,00</b>



**ZCOL632..** KOLUMNA WANNOWA

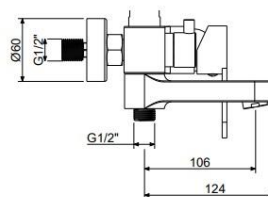

<b>CR</b>	CHROM	<b>1700,00</b>
<b>*BO</b>	BIAŁY MAT	<b>2600,00</b>
<b>NO</b>	CZARNY MAT	<b>2600,00</b>

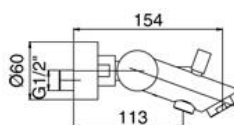

**BI022..** BATERIA WANNOWA ŚCIENNA (KORPUS)  
**BI023..** BATERIA WANNOWA ŚCIENNA (KOMPLETNA)

**INDEKS BI022**  
**CR** CHROM **1100,00**

**INDEKS BI023**  
**CR** CHROM **1360,00**

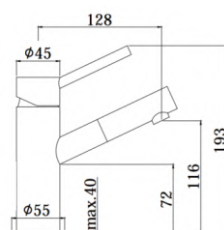

**BI071..** BATERIA UMYWALKOWA STOJĄCA (BEZ KORKA)  
**BI071K..** BATERIA UMYWALKOWA STOJĄCA (KOREK CLICK CLACK)

**INDEKS BI071**  
**CR** CHROM **585,00**

**INDEKS BI071K**  
**CR** CHROM **665,00**

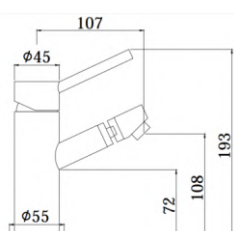

**BI131..** BATERIA BIDETOWA STOJĄCA (BEZ KORKA)  
**BI131K..** BATERIA BIDETOWA STOJĄCA (KOREK CLICK CLACK)

**INDEKS BI131**  
**CR** CHROM **585,00**

**INDEKS BI131K**  
**CR** CHROM **665,00**

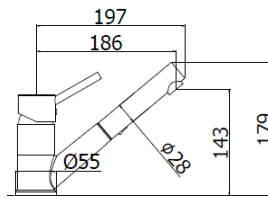

**BI183..**

BATERIA ZLEWOZMYWAKOWA STOJĄCA Z WYCIĄGANYM WĘŻEM

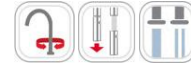

CR

CHROM

620,00



SKŁAD ZESTAWU:

- DESZCZOWNICA:  
(INDEKS F) SNO250
- RAMIĘ ŚCIENNE L-300MM
- ZESTAW 3W1 ZDUP094

Ø250MM, WERSJA SLIM –AP-



CR

CHROM

1605,00

**BI015ZSCF..**

ZESTAW NATRYSKOWY PODTYNKOWY

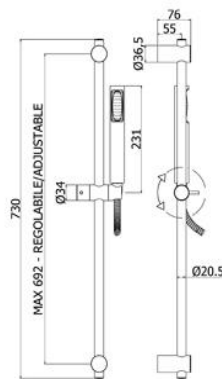

**ZSAL150..**

ZESTAW NATRYSKOWY **STICK NEW**



CR

CHROM

300,00



**CA004..** BATERIA UMYWALKOWA PODTYNKOWA L-120MM

**CA006..** BATERIA UMYWALKOWA PODTYNKOWA L-175MM

**CA007..** BATERIA UMYWALKOWA PODTYNKOWA L-245MM

CR CHROM 600,00

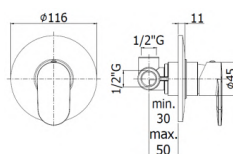

**CA010..** BATERIA PODTYNKOWA 1-DROŻNA

CR CHROM 260,00

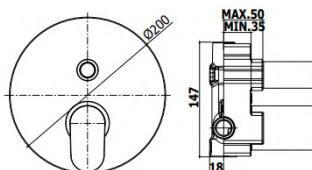

**CA015..** BATERIA PODTYNKOWA 2-DROŻNA

CR CHROM 575,00

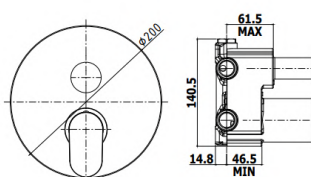

**CA018..** BATERIA PODTYNKOWA 2-DROŻNA Z PRZEŁĄCZNIKIEM MECHANICZNYM

**CA019..** BATERIA PODTYNKOWA 3-DROŻNA Z PRZEŁĄCZNIKIEM MECHANICZNYM

CR CHROM 1000,00



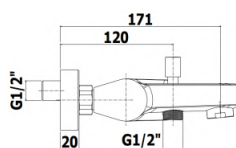

**CA022..** BATERIA WANNOWA ŚCIENNA (KORPUS)  
**CA023..** BATERIA WANNOWA ŚCIENNA (KOMPLETNA)

**INDEKS CA022**  
**CR** CHROM 820,00

**INDEKS CA023**  
**CR** CHROM 950,00

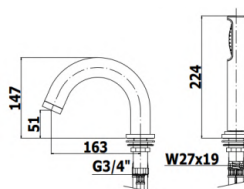

**CA040..** BATERIA WANNOWA 3-OTWOROWA  
**CA041..** BATERIA WANNOWA 2-OTWOROWA (BEZ WYLEWKI)

**INDEKS CA040**  
**CR** CHROM 1400,00

**INDEKS CA041**  
**CR** CHROM 940,00

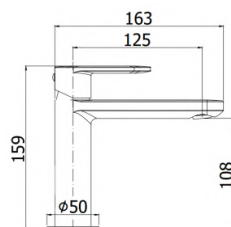

**CA071..** BATERIA UMYWALKOWA STOJĄCA (BEZ KORKA)  
**CA071K..** BATERIA UMYWALKOWA STOJĄCA (KOREK CLICK CLACK)

**INDEKS CA071**  
**CR** CHROM 420,00

**INDEKS CA071K**  
**CR** CHROM 500,00

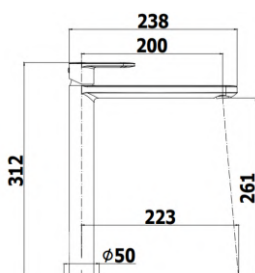

**CA081..** BATERIA UMYWALKOWA WYSOKA (BEZ KORKA)  
**CA081K..** BATERIA UMYWALKOWA WYSOKA (KOREK CLICK CLACK)

**INDEKS CA081**  
**CR** CHROM 840,00

**INDEKS CA081K**  
**CR** CHROM 920,00

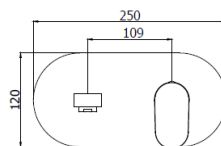

**CA105..**

BATERIA UMYWALKOWA PODTYNKOWA L-200MM

CR

CHROM

1080,00

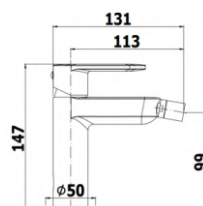

**CA131..**

BATERIA BIDETOWA STOJĄCA (BEZ KORKA)

INDEKS CA131

CR

CHROM

420,00

**CA131K..**

BATERIA BIDETOWA STOJĄCA (KOREK CLICK CLACK)

INDEKS CA131K

CR

CHROM

500,00

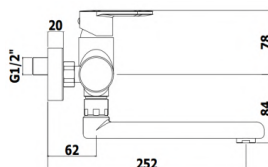

**CA161..**

BATERIA UMYWALKOWA ŚCIENNA

CR

CHROM

580,00

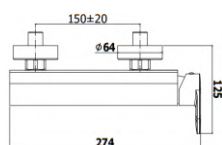

**CA168..**

BATERIA NATRYSKOWA ŚCIENNA (KORPUS)

INDEKS CA168

CR

CHROM

590,00

**CA168D..**

BATERIA NATRYSKOWA ŚCIENNA (KOMPLETNA)

INDEKS CA168D

CR

CHROM

740,00

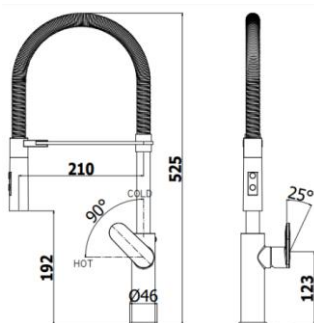

**CR** CHROM/SREBRNY **1480,00**  
**CRNO** CHROM/CZARNY **1505,00**

**CA179..** BATERIA ZLEWOZMYWAKOWA STOJĄCA Z WĘŻEM OPERACYJNYM

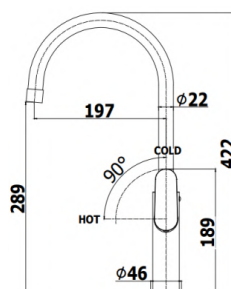

**CR** CHROM **710,00**

**CA180..** BATERIA ZLEWOZMYWAKOWA STOJĄCA



- PODŁĄCZENIE PODTYNKOWE ZACC130CR  
 - ZESTAW NATRYSKOWY:  
 (INDEKS 3) ZSAL150  
 (INDEKS 6) C06685 -EMMEVI-

**CA010ZN3** ZESTAW NATRYSKOWY PODTYNKOWY **655,00**

**CA010ZN6** ZESTAW NATRYSKOWY PODTYNKOWY **725,00**



**SKŁAD ZESTAWU:**  
 - DESZCZOWNICA:  
 (INDEKS A) ZSOF074 **Ø225MM**  
 (INDEKS B) SNO300 **Ø300MM, SLIM** -AP-  
 (INDEKS F) SNO250 **Ø250MM, SLIM** -AP-  
 - RAMIĘ ŚCIENNE L-400MM  
 - PODŁĄCZENIE PODTYNKOWE ZACC130  
 - ZESTAW NATRYSKOWY C06685 -EMMEVI-



**INDEKS A** ZSOF074 **Ø225mm**  
**CR** CHROM **1700,00**

**INDEKS B** SNO300 **Ø300mm**  
**CR** CHROM **1670,00**

**INDEKS F** SNO250 **Ø250mm**  
**CR** CHROM **1590,00**

**CA015ZN3..**

ZESTAW NATRYSKOWY PODTYNKOWY



**SKŁAD ZESTAWU:**  
 - DESZCZOWNICA:  
 (INDEKS A) ZSOF074 **Ø225MM**  
 (INDEKS F) SNO250 **Ø250MM, SLIM** -AP-  
 - RAMIĘ ŚCIENNE L-400MM  
 - ZESTAW 3W1 ZDUP094



**INDEKS A** ZSOF074 **Ø225mm**  
**CR** CHROM **1605,00**

**INDEKS F** SNO250 **Ø250mm**  
**CR** CHROM **1495,00**

**CA015ZSC3..**

ZESTAW NATRYSKOWY PODTYNKOWY

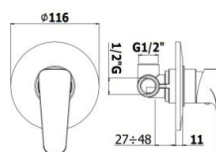

**SY010..**

BATERIA PODTYNKOWA 1-DROŻNA

CR

CHROM

240,00

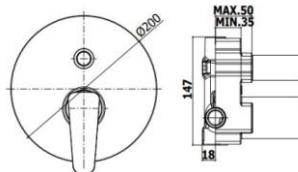

**SY015..**

BATERIA PODTYNKOWA 2-DROŻNA

CR

CHROM

555,00

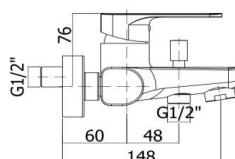

INDEKS SY022

CR

CHROM

650,00

**SY022..**

BATERIA WANNOWA ŚCIENNA (KORPUS)

**SY024..**

BATERIA WANNOWA ŚCIENNA (KOMPLETNA)

CR

INDEKS SY024

CHROM

750,00

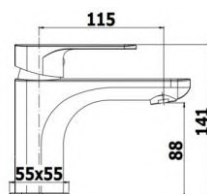

**SY071..**  
**SY071K..**

BATERIA UMYWALKOWA STOJĄCA (BEZ KORKA)  
BATERIA UMYWALKOWA STOJĄCA (KOREK CLICK CLACK)

**INDEKS SY071**  
**CR** CHROM **440,00**

**INDEKS SY071K**  
**CR** CHROM **520,00**

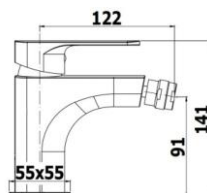

**SY131..**

BATERIA BIDETOWA STOJĄCA (BEZ KORKA)

**CR** CHROM **440,00**

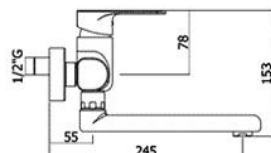

**SY161..**

BATERIA UMYWALKOWA ŚCIENNA

**CR** CHROM **580,00**

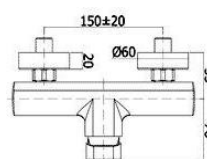

**SY168..**  
**SY168D..**

BATERIA NATRYSKOWA ŚCIENNA (KORPUS)  
BATERIA NATRYSKOWA ŚCIENNA (KOMPLETNA)



**INDEKS SY168**  
**CR** CHROM **520,00**

**INDEKS SY168D**  
**CR** CHROM **590,00**

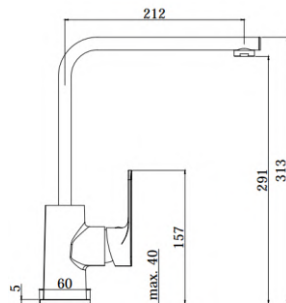

**SY180..**

BATERIA ZLEWOZMYWAKOWA STOJĄCA

CR

CHROM

875,00

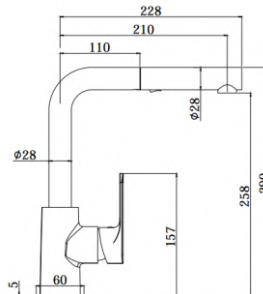

**SY285..**

BATERIA ZLEWOZMYWAKOWA STOJĄCA

CR

CHROM

820,00



SKŁAD ZESTAWU:

- DESZCZOWNICA:

(INDEKS A) ZSOF074

(INDEKS B) SNO300

(INDEKS F) SNO250

- RAMIĘ ŚCIENNE L-400MM

- ZESTAW 3W1 ZDUP094

Ø225MM

Ø300MM, SLIM -AP-

Ø250MM, SLIM -AP-



**INDEKS A** ZSOF074 Ø225mm  
A.CR CHROM 1675,00

**INDEKS B** SNO300 Ø300mm  
B.CR CHROM 1580,00

**INDEKS F** SNO250 Ø250mm  
F.CR CHROM 1520,00

**SY015ZSC3..**

ZESTAW NATRYSKOWY PODTYNKOWY

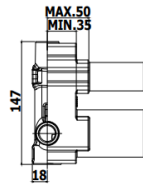
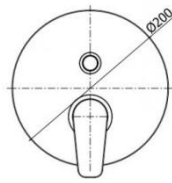

LM015..

BATERIA PODTYNKOWA 2-DROŻNA

CR

CHROM

610,00

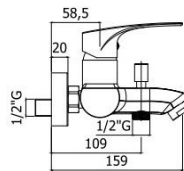

LM022..

BATERIA WANNOWA ŚCIENNA (KORPUS)

CR

CHROM

630,00

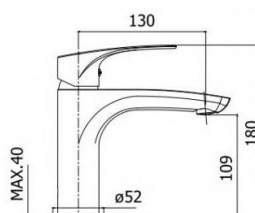

LM071..

BATERIA UMYWALKOWA STOJĄCA (BEZ KORKA)

INDEKS LM071

CR

CHROM

400,00

LM071K..

BATERIA UMYWALKOWA STOJĄCA (KOREK CLICK CLACK)

INDEKS LM071K

CR

CHROM

480,00



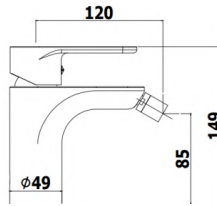

**LM135..** BATERIA BIDETOWA STOJĄCA (KOREK AUTOMATYCZNY)

**CR** CHROM 470,00

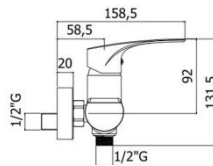

**LM168..** BATERIA NATRYSKOWA ŚCIENNA (KORPUS)

**CR** CHROM 500,00



- SKŁAD ZESTAWU:**
- PODŁĄCZENIE PODTYNKOWE Z UCHWYTEM 2W1 ZSUP031CR
  - RĄCZKA NATRYSKOWA ZDOC104
  - WĄŻ PRYSZNICOWY L-150CM
  - WYLEWKA ŚCIENNA L-17,5CM



**LM015ZWW..** BATERIA WANNOWA PODTYNKOWA Z WYLEWKĄ L-175MM

**CR** CHROM 1280,00



- SKŁAD ZESTAWU:**
- DESZCZOWNICA:
    - (INDEKS A) ZSOF074 Ø225MM
    - (INDEKS B) SNO300 Ø300MM, SLIM -AP-
    - (INDEKS F) SNO250 Ø250MM, SLIM -AP-
  - RAMIĘ ŚCIENNE L-400MM
  - PODŁĄCZENIE PODTYNKOWE Z UCHWYTEM 2W1 ZSUP031CR
  - RĄCZKA NATRYSKOWA ZDOC104
  - WĄŻ PRYSZNICOWY L-150CM



**A.CR** indeks A ZSOF074 Ø200mm CHROM 1620,00

**B.CR** indeks B SNO300 Ø300mm CHROM 1600,00

**F.CR** indeks F SNO250 Ø250mm CHROM 1500,00

**LM015ZSC3..** ZESTAW NATRYSKOWY PODTYNKOWY

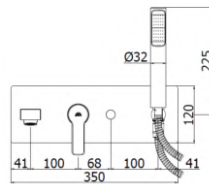

**RED001..**

BATERIA WANNOWA PODTYNKOWA ZESPOLONA

CR

CHROM

1980,00

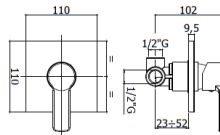

**RED10..**

BATERIA PODTYNKOWA 1-DROŻNA

CR

CHROM

270,00

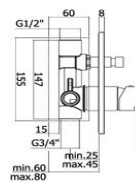

**RED15..**

BATERIA PODTYNKOWA 2-DROŻNA

CR

CHROM

530,00

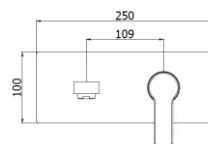

**RED105..**

BATERIA UMYWALKOWA PODTYNKOWA L-200MM

CR

CHROM

1030,00

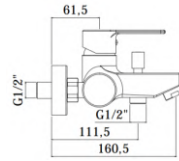

INDEKS **RED022**

**CR** CHROM 610,00

**RED022..** BATERIA WANNOWA ŚCIENNA (KORPUS)  
**RED024..** BATERIA WANNOWA ŚCIENNA (KOMPLETNA)

INDEKS **RED024**

**CR** CHROM 690,00

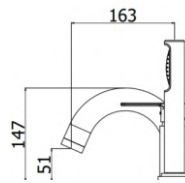

**CR** CHROM 1370,00

**RED040L..** BATERIA WANNOWA 3-OTWOROWA

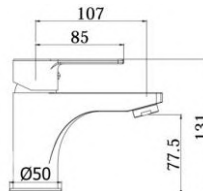

INDEKS **RED071**

**CR** CHROM 330,00

**RED071..** BATERIA UMYWALKOWA STOJĄCA (BEZ KORKA)

INDEKS **RED071K**

**CR** CHROM 395,00

**RED071K..** BATERIA UMYWALKOWA STOJĄCA (KOREK CLICK CLACK)

INDEKS **RED071EWS**

**\*CR** CHROM 365,00

**RED071EWS..** BATERIA UMYWALKOWA STOJĄCA (BEZ KORKA) COLD START

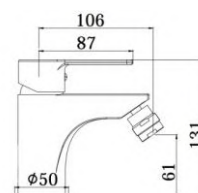

INDEKS **RED131**

**CR** CHROM 330,00

**RED131..** BATERIA UMYWALKOWA STOJĄCA (BEZ KORKA)

INDEKS **RED131K**

**CR** CHROM 395,00

**RED131K..** BATERIA UMYWALKOWA STOJĄCA (KOREK CLICK CLACK)

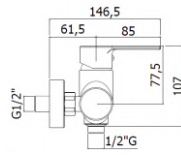

**RED168..** BATERIA NATRYSKOWA SCIENNA (KORPUS)  
**RED168D..** BATERIA NATRYSKOWA SCIENNA (KOMPLETNA)

**INDEKS RED168**  
**CR** CHROM 450,00

**INDEKS RED168D**  
**CR** CHROM 520,00

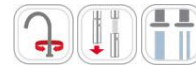
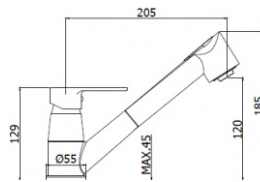

**RED183..** BATERIA ZLEWOZMYWAKOWA STOJĄCA Z WĘŻEM OPERACYJNYM

**CR** CHROM 555,00



**SKŁAD ZESTAWU:**

- DESZCZOWNICA:  
 (INDEKS A) ZSOF075 200x200mm  
 (INDEKS B) SNK300 300x300mm, SLIM -AP-  
 (INDEKS F) SNK250 250x250mm, SLIM -AP-
- RAMIĘ ŚCIENNE L-400MM
- ZESTAW 3W1 ZDUP095



**INDEKS A** ZSOF075 200x200mm  
**A.CR** CHROM 1775,00

**INDEKS B** SNK300 300x300mm  
**B.CR** CHROM 1695,00

**INDEKS B** SNK250 250x250mm  
**F.CR** CHROM 1615,00

**RED015ZSC3..** ZESTAW NATRYSKOWY PODTYNKOWY

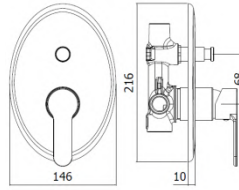

**BLU015..**

BATERIA PODTYNKOWA 2-DROŻNA

**CR**

CHROM

**570,00**

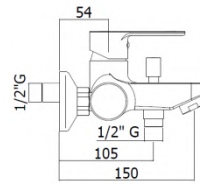

**INDEKS BLU022**

**CR**

CHROM

**520,00**

**BLU022..**

BATERIA WANNOWA ŚCIENNA (KORPUS)

**BLU023..**

BATERIA WANNOWA ŚCIENNA (KOMPLETNA)

**INDEKS BLU023**

**CR**

CHROM

**590,00**

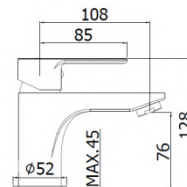

**INDEKS BLU071**

**CR**

CHROM

**285,00**

**BLU071..**

BATERIA UMYWALKOWA STOJĄCA (BEZ KORKA)

**BLU071K..**

BATERIA UMYWALKOWA STOJĄCA (KOREK CLICK CLACK)

**INDEKS BLU071K**

**CR**

CHROM

**365,00**

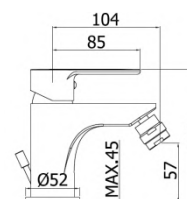

**BLU135..**

BATERIA BIDETOWA STOJĄCA (KOREK AUTOMATYCZNY)

**CR**

CHROM

**350,00**



**BLU161..** BATERIA UMYWALKOWA ŚCIENNA

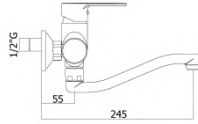

**CR** CHROM 460,00



**BLU168..** BATERIA NATRYSKOWA ŚCIENNA (KORPUS)  
**BLU168D..** BATERIA NATRYSKOWA ŚCIENNA (KOMPLETNA)

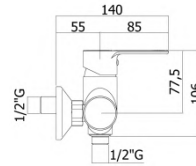

**CR** INDEKS **BLU168** CHROM 380,00

**CR** INDEKS **BLU168D** CHROM 455,00



**BLU183..** BATERIA ZLEWOZMYWAKOWA STOJĄCA Z WĘŻEM OPERACYJNYM

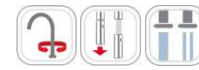
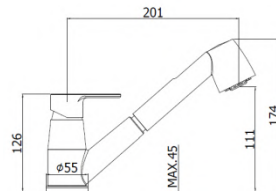

**CR** CHROM 590,00



**SKŁAD ZESTAWU:**  
- DESZCZOWNICA:  
(INDEKS **A**) ZSOF074 Ø225MM  
(INDEKS **B**) SNO300 Ø300MM, SLIM -AP-  
(INDEKS **F**) SNO250 Ø250MM, SLIM -AP-  
- RAMIĘ ŚCIENNE L-400MM  
- ZESTAW 3W1 ZDUP094



**A.CR** indeks **A** ZSOF074 Ø225mm CHROM 1590,00

**B.CR** indeks **B** SNO300 Ø300mm CHROM 1545,00

**F.CR** indeks **F** SNO250 Ø250mm CHROM 1465,00

**BLU015ZSC3..** ZESTAW NATRYSKOWY PODTYNKOWY

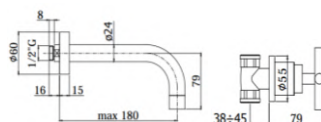

- QTV004..** BATERIA UMYWALKOWA PODTYNKOWA L-120MM
- QTV003..** BATERIA UMYWALKOWA PODTYNKOWA L-175MM
- QTV008..** BATERIA UMYWALKOWA PODTYNKOWA L-245MM

**CR** CHROM **770,00**

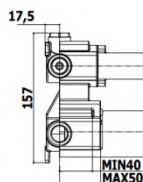
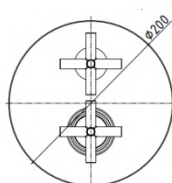

- QTV018..** BATERIA PODTYNKOWA 2-DROŻNA **TERMOSTAT**
- QTV019..** BATERIA PODTYNKOWA 3-DROŻNA **TERMOSTAT**

**CR** CHROM **1750,00**

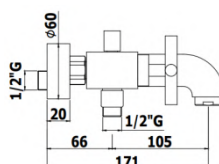

- QTV022..** BATERIA WANNOWA ŚCIENNA (KORPUS)
- QTV023..** BATERIA WANNOWA ŚCIENNA (KOMPLETNA)
- QTV023KOL..** BATERIA WANNOWA WOLNOSTOJĄCA (KOLANA C02850 \*EMMEVI\*)

**CR** CHROM **INDEKS QTV022** **920,00**

**CR** CHROM **INDEKS QTV023** **1180,00**

**CR** CHROM **INDEKS QTV023KOL** **1800,00**

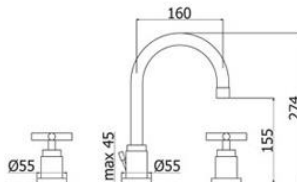

**QTV052..** BATERIA UMYWALKOWA 3-OTWOROWA (BEZ KORKA)  
**QTV052K..** BATERIA UMYWALKOWA 3-OTWOROWA (KOREK CLICK CLACK)

**CR** CHROM **INDEKS QTV052** 1160,00

**CR** CHROM **INDEKS QTV052K** 1240,00

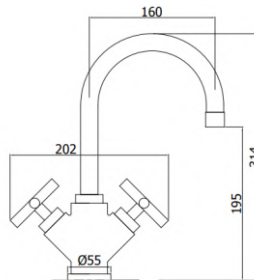

**QTV078..** BATERIA UMYWALKOWA STOJĄCA (BEZ KORKA)  
**QTV078K..** BATERIA UMYWALKOWA STOJĄCA (KOREK CLICK CLACK)

**CR** CHROM **INDEKS QTV078** 920,00

**CR** CHROM **INDEKS QTV078K** 1000,00

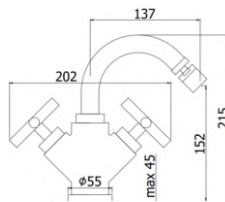

**QTV137..** BATERIA BIDETOWA STOJĄCA (KOREK AUTOMATYCZNY)

**CR** CHROM 1010,00

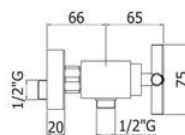

**QTV168..** BATERIA NATRYSKOWA ŚCIENNA (KORPUS)  
**QTV168D..** BATERIA NATRYSKOWA ŚCIENNA (KOMPLETNA)

**CR** CHROM **INDEKS QTV168** 650,00

**CR** CHROM **INDEKS QTV168D** 920,00



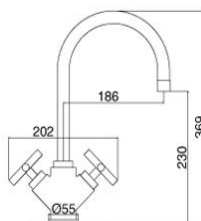

**QTV180..**

BATERIA ZLEWOZMYWAKOWA STOJĄCA

CR

CHROM

980,00



**SKŁAD ZESTAWU:**  
- ZESTAW 3W1 ZDUP094  
- WYLEWKA ŚCIENNA L-175MM



**QTV010ZWW..**

ZESTAW WANNOWY PODTYNKOWY (WYLEWKA L-175MM)

CR

CHROM

1760,00



**SKŁAD ZESTAWU:**  
- DESZCZOWNICA:  
(INDEKS F) SNO250 Ø250MM, SLIM -AP-  
- RAMIĘ ŚCIENNE L-400MM  
- ZESTAW 3W1 ZDUP094



**QTV010ZSC3F..**

ZESTAW NATRYSKOWY PODTYNKOWY

CR

CHROM

2105,00



- SKŁAD ZESTAWU:**  
 - DESZCZOWNICA:  
 (INDEKS F) SNO250 **Ø250MM, SLIM -AP-**  
 - RAMIĘ ŚCIENNE L-400MM  
 - ZESTAW 3W1 ZDUP094



**QTV018ZSC3F..**

ZESTAW NATRYSKOWY P/T TERMOSTATYCZNY (RAMIĘ 400MM)

CR

CHROM

2755,00

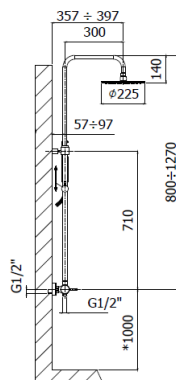
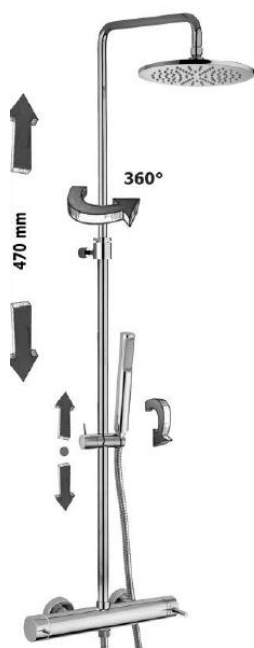

**ZCOL599..**

KOLUMNA NATRYSKOWA **MINI MASTER NEW**



CR

CHROM

2150,00

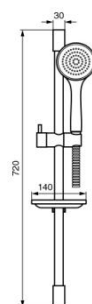

**C06685..**

ZESTAW NATRYSKOWY **NEFER**

-EMMEVI-



CR

CHROM

370,00

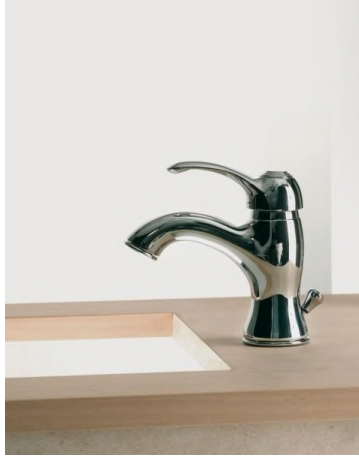
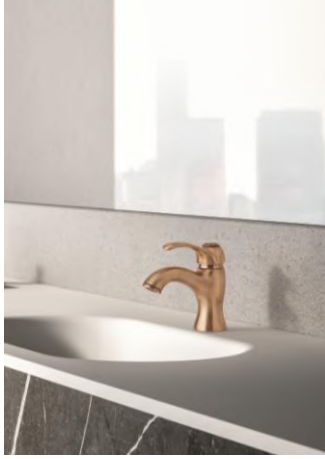

**FA015..**

BATERIA PODTYNKOWA 2-DROŻNA

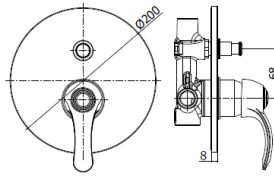

<b>CR</b>	CHROM	<b>680,00</b>
<b>CO</b>	CHROM/ZŁOTO	<b>850,00</b>
<b>BR</b>	STARE ZŁOTO	<b>1220,00</b>
<b>*RM</b>	MIEDŹ SZCZOTKOWANA	<b>1220,00</b>



**FA022..**

BATERIA WANNOWA ŚCIENNA (KORPUS)

**FA024..**

BATERIA WANNOWA ŚCIENNA (KOMPLETNA)

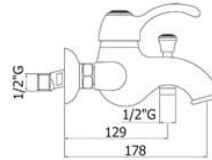

**INDEKS FA022**

<b>CR</b>	CHROM	<b>900,00</b>
<b>CO</b>	CHROM/ZŁOTO	<b>1100,00</b>
<b>BR</b>	STARE ZŁOTO	<b>1620,00</b>
<b>*RM</b>	MIEDŹ SZCZOTKOWANA	<b>1620,00</b>

**INDEKS FA024**

<b>CR</b>	CHROM	<b>1050,00</b>
<b>CO</b>	CHROM/ZŁOTO	<b>1250,00</b>
<b>BR</b>	STARE ZŁOTO	<b>1850,00</b>
<b>*RM</b>	MIEDŹ SZCZOTKOWANA	<b>1850,00</b>



**FA045..**

BATERIA WANNOWA 3-OTWOROWA



<b>CR</b>	CHROM	<b>1910,00</b>
<b>*CO</b>	CHROM/ZŁOTO	<b>2300,00</b>
<b>BR</b>	STARE ZŁOTO	<b>3500,00</b>
<b>*RM</b>	MIEDŹ SZCZOTKOWANA	<b>3500,00</b>

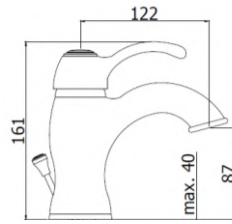

**FA075..**

BATERIA UMYWALKOWA STOJĄCA (KOREK AUTOMATYCZNY)

<b>CR</b>	CHROM	<b>710,00</b>
<b>CO</b>	CHROM/ZŁOTO	<b>850,00</b>
<b>BR</b>	STARE ZŁOTO	<b>1280,00</b>
<b>*RM</b>	MIEDŹ SZCZOTKOWANA	<b>1280,00</b>

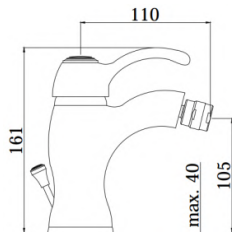

**FA135..**

BATERIA BIDETOWA STOJĄCA (KOREK AUTOMATYCZNY)

<b>CR</b>	CHROM	<b>710,00</b>
<b>CO</b>	CHROM/ZŁOTO	<b>850,00</b>
<b>BR</b>	STARE ZŁOTO	<b>1280,00</b>
<b>*RM</b>	MIEDŹ SZCZOTKOWANA	<b>1280,00</b>

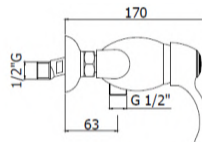

**FA168..**

BATERIA NATRYSKOWA ŚCIENNA (KORPUS)

**FA168D..**

BATERIA NATRYSKOWA ŚCIENNA (KOMPLETNA)



**INDEKS FA168**

<b>*CR</b>	CHROM	<b>650,00</b>
<b>*CO</b>	CHROM/ZŁOTO	<b>800,00</b>
<b>*BR</b>	STARE ZŁOTO	<b>1150,00</b>
<b>*RM</b>	MIEDŹ SZCZOTKOWANA	<b>1150,00</b>

**INDEKS FA168D**

<b>*CR</b>	CHROM	<b>820,00</b>
<b>*CO</b>	CHROM/ZŁOTO	<b>980,00</b>
<b>*BR</b>	STARE ZŁOTO	<b>1500,00</b>
<b>*RM</b>	MIEDŹ SZCZOTKOWANA	<b>1500,00</b>

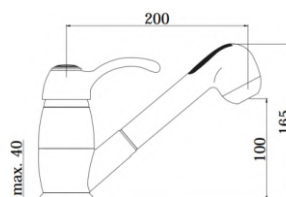

**FA183..**

BATERIA ZLEWOZMYWAKOWA STOJĄCA Z WĘŻEM OPERACYJNYM

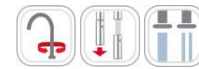

<b>*CR</b>	CHROM	<b>680,00</b>
<b>*CO</b>	CHROM/ZŁOTO	<b>830,00</b>
<b>*BR</b>	STARE ZŁOTO	<b>1230,00</b>
<b>*RM</b>	MIEDŹ SZCZOTKOWANA	<b>1230,00</b>



**FA015ZWW..** ZESTAW WANNOWY PODTYNKOWY

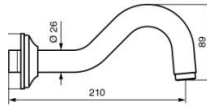

<b>CR</b>	CHROM	<b>1290,00</b>
<b>*CO</b>	CHROM/ZŁOTO	<b>1510,00</b>
<b>BR</b>	STARE ZŁOTO	<b>2255,00</b>



**FA015ZSCF..** ZESTAW NATRYSKOWY PODTYNKOWY

**SKŁAD ZESTAWU:**  
 - DESZCZOWNICA:  
 (INDEKS F) C00655-205MM -EMMEVI-  
 - RAMIĘ ŚCIENNE C00684 L-325MM -EMMEVI-  
 - ZESTAW 3W1 157 -EMMEVI-



<b>CR</b>	CHROM	<b>2000,00</b>
<b>*CO</b>	CHROM/ZŁOTO	<b>2350,00</b>
<b>BR</b>	STARE ZŁOTO	<b>3380,00</b>



**FA015ZNF..** ZESTAW NATRYSKOWY PODTYNKOWY

**SKŁAD ZESTAWU:**  
 - DESZCZOWNICA:  
 (INDEKS F) C00655-205MM -EMMEVI-  
 - RAMIĘ ŚCIENNE C00684 L-325MM -EMMEVI-  
 - ZESTAW NATRYSKOWY C02541 - EMMEVI -  
 - PRZYŁĄCZE KĄTOWE C06908 - EMMEVI-



<b>CR</b>	CHROM	<b>2470,00</b>
<b>*CO</b>	CHROM/ZŁOTO	<b>3440,00</b>
<b>BR</b>	STARE ZŁOTO	<b>4180,00</b>

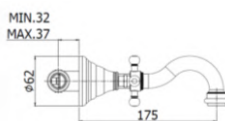

**FBLV003..** BATERIA UMYWALKOWA PODTYNKOWA L-175MM  
**FBLV008..** BATERIA UMYWALKOWA PODTYNKOWA L-245MM

<b>*CR</b>	CHROM	<b>1000,00</b>
<b>BR</b>	STARE ZŁOTO	<b>1800,00</b>
<b>*RM</b>	MIEDŹ SZCZOTKOWANA	<b>1800,00</b>

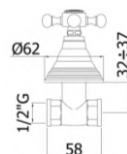

**FBLV010..** ZAWÓR PODTYNKOWY

<b>*CR</b>	CHROM	<b>320,00</b>
<b>BR</b>	STARE ZŁOTO	<b>580,00</b>
<b>*RM</b>	MIEDŹ SZCZOTKOWANA	<b>580,00</b>

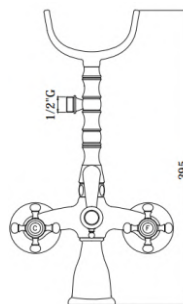

**FBLV023..** BATERIA WANNOWA ŚCIENNA (KOMPLETNA)

	<b>*CR</b>	CHROM	<b>1950,00</b>
	<b>BR</b>	STARE ZŁOTO	<b>3500,00</b>
	<b>*RM</b>	MIEDŹ SZCZOTKOWANA	<b>3500,00</b>



	<b>*CR</b>	CHROM	<b>2700,00</b>
	<b>BR</b>	STARE ZŁOTO	<b>4800,00</b>
	<b>*RM</b>	MIEDŹ SZCZOTKOWANA	<b>4800,00</b>

**FBLV040..** BATERIA WANNOWA 5-OTWOROWA

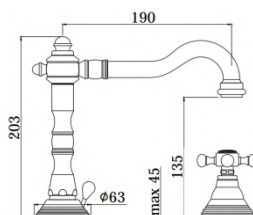

<b>*CR</b>	CHROM	<b>1500,00</b>
<b>BR</b>	STARE ZŁOTO	<b>2700,00</b>
<b>*RM</b>	MIEDŹ SZCZOTKOWANA	<b>2700,00</b>

**FBLV055..** BATERIA UMYWALKOWA STOJĄCA (KOREK AUTOMATYCZNY)

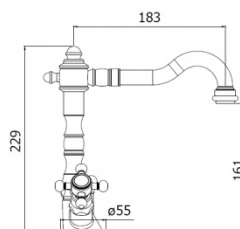

<b>*CR</b>	CHROM	<b>1200,00</b>
<b>BR</b>	STARE ZŁOTO	<b>2150,00</b>
<b>*RM</b>	MIEDŹ SZCZOTKOWANA	<b>2150,00</b>

**FBLV075..** BATERIA UMYWALKOWA STOJĄCA (KOREK AUTOMATYCZNY)

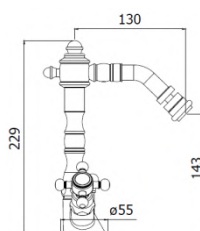

<b>*CR</b>	CHROM	<b>1200,00</b>
<b>BR</b>	STARE ZŁOTO	<b>2150,00</b>
<b>*RM</b>	MIEDŹ SZCZOTKOWANA	<b>2150,00</b>

**FBLV135..** BATERIA BIDETOWA STOJĄCA (KOREK AUTOMATYCZNY)

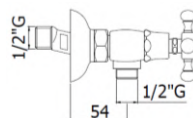

**INDEKS FBLV168**

<b>*CR</b>	CHROM	<b>600,00</b>
<b>*BR</b>	STARE ZŁOTO	<b>1100,00</b>
<b>*RM</b>	MIEDŹ SZCZOTKOWANA	<b>1100,00</b>

**FBLV168..** BATERIA NATRYSKOWA ŚCIENNA (KORPUS)

**FBLV168D..** BATERIA NATRYSKOWA ŚCIENNA (KOMPLETNA)

**INDEKS FBLV168D**

<b>*CR</b>	CHROM	<b>910,00</b>
<b>*BR</b>	STARE ZŁOTO	<b>1640,00</b>
<b>*RM</b>	MIEDŹ SZCZOTKOWANA	<b>1640,00</b>

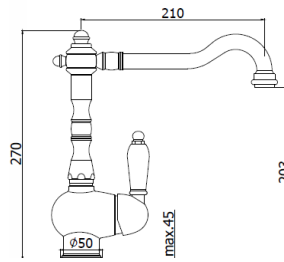

**FME181..** BATERIA ZLEWOZMYWAKOWA STOJĄCA



<b>CR</b>	CHROM	<b>1080,00</b>
<b>BR</b>	STARE ZŁOTO	<b>1910,00</b>
<b>*RM</b>	MIEDŹ SZCZOTKOWANA	<b>1910,00</b>

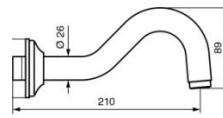

**FBLV010ZWW..** ZESTAW WANNOWY PODTYNKOWY



<b>CR</b>	CHROM	<b>1805,00</b>
<b>BR</b>	STARE ZŁOTO	<b>3065,00</b>



- SKŁAD ZESTAWU:**  
 - DESZCZOWNICA:  
 (INDEKS F) C00655-205MM -  
 EMMEVI-  
 - RAMIĘ ŚCIENNE C00684 L-325MM  
 -EMMEVI-  
 -PRZEŁĄCZNIK 2-DROŻNY 121019  
 - ZESTAW 3W1 157

**FBLV010ZSCF..** ZESTAW NATRYSKOWY PODTYNKOWY



<b>CR</b>	CHROM	<b>2515,00</b>
<b>BR</b>	STARE ZŁOTO	<b>4200,00</b>





**SKŁAD ZESTAWU:**  
 - DESZCZOWNICA:  
 (INDEKS F) C00655-205MM -EMMEVI-  
 - RAMIĘ ŚCIENNE C00684 L-325MM -EMMEVI-  
 ZESTAW NATRYSKOWY C02541  
 - PRZYŁĄCZE KĄTOWE C06908



**CR** CHROM **2985,00**  
**BR** STARE ZŁOTO **4990,00**

**FBLV010ZNF..** ZESTAW NATRYSKOWY PODTYNKOWY

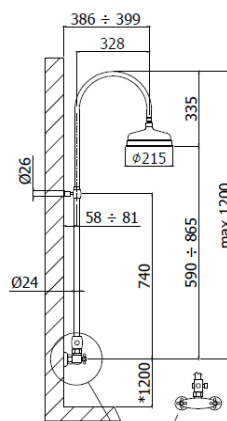
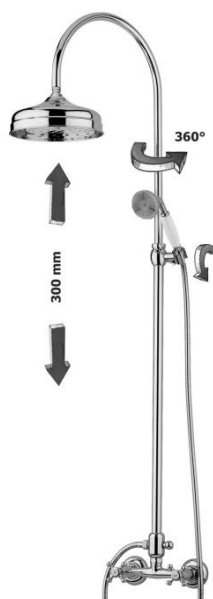

**CR** CHROM **3500,00**  
**BR** STARE ZŁOTO **6200,00**

**ZCOL000..** KOLUMNA NATRYSKOWA BELINDA

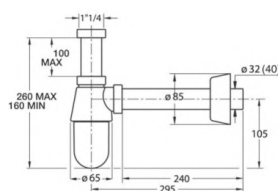
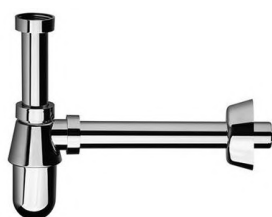

**CR** CHROM **85,00**

**BO0570..** PÓŁSYFON UMYWALKOWY THERMO -BONOMINI- ABS+BRASS



**IRV010..**

ZAWÓR PODTYNKOWY

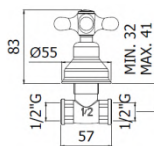

<b>CR</b>	CHROM	<b>210,00</b>
<b>*CO</b>	CHROM/ZŁOTO	<b>240,00</b>
<b>*GF</b>	ZŁOTO	<b>430,00</b>
<b>*BR</b>	STARE ZŁOTO	<b>350,00</b>



**IRV022..**

BATERIA WANNOWA ŚCIENNA (KOMPLETNA)

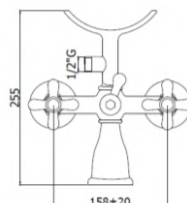

<b>CR</b>	CHROM	<b>1030,00</b>
<b>*CO</b>	CHROM/ZŁOTO	<b>1250,00</b>
<b>*GF</b>	ZŁOTO	<b>2230,00</b>
<b>*BR</b>	STARE ZŁOTO	<b>1850,00</b>



**IRV027..**

BATERIA WANNOWA ŚCIENNA (KOMPLETNA)

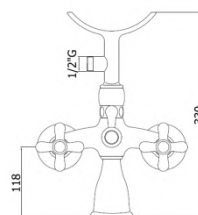

<b>CR</b>	CHROM	<b>1200,00</b>
<b>*CO</b>	CHROM/ZŁOTO	<b>1450,00</b>
<b>*GF</b>	ZŁOTO	<b>2700,00</b>
<b>*BR</b>	STARE ZŁOTO	<b>2200,00</b>



**IRV044..**

BATERIA WANNOWA 5-OTWOROWA



<b>CR</b>	CHROM	<b>2200,00</b>
<b>*CO</b>	CHROM/ZŁOTO	<b>2650,00</b>
<b>*GF</b>	ZŁOTO	<b>4800,00</b>
<b>*BR</b>	STARE ZŁOTO	<b>3950,00</b>



**IRV055..**

BATERIA UMYWALKOWA STOJĄCA (KOREK AUTOMATYCZNY)

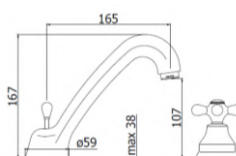

<b>CR</b>	CHROM	<b>930,00</b>
<b>*CO</b>	CHROM/ZŁOTO	<b>1100,00</b>
<b>*GF</b>	ZŁOTO	<b>2020,00</b>
<b>*BR</b>	STARE ZŁOTO	<b>1650,00</b>

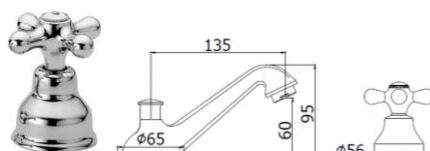

**IRV058..** BATERIA UMYWALKOWA STOJĄCA (KOREK AUTOMATYCZNY)

<b>CR</b>	CHROM	<b>900,00</b>
<b>*CO</b>	CHROM/ZŁOTO	<b>1060,00</b>
<b>*GF</b>	ZŁOTO	<b>1950,00</b>
<b>*BR</b>	STARE ZŁOTO	<b>1600,00</b>

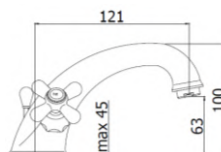

**IRV065..** BATERIA UMYWALKOWA STOJĄCA (KOREK AUTOMATYCZNY)

<b>CR</b>	CHROM	<b>580,00</b>
<b>*CO</b>	CHROM/ZŁOTO	<b>700,00</b>
<b>*GF</b>	ZŁOTO	<b>1300,00</b>
<b>*BR</b>	STARE ZŁOTO	<b>1050,00</b>

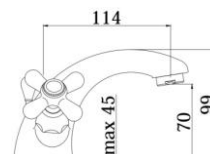

**IRV075..** BATERIA UMYWALKOWA STOJĄCA (KOREK AUTOMATYCZNY)

<b>CR</b>	CHROM	<b>580,00</b>
<b>*CO</b>	CHROM/ZŁOTO	<b>700,00</b>
<b>*GF</b>	ZŁOTO	<b>1250,00</b>
<b>*BR</b>	STARE ZŁOTO	<b>1040,00</b>

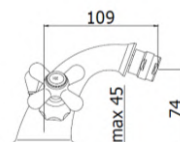

**IRV135..** BATERIA BIDETOWA STOJĄCA (KOREK AUTOMATYCZNY)

<b>CR</b>	CHROM	<b>580,00</b>
<b>*CO</b>	CHROM/ZŁOTO	<b>700,00</b>
<b>*GF</b>	ZŁOTO	<b>1250,00</b>
<b>*BR</b>	STARE ZŁOTO	<b>1040,00</b>

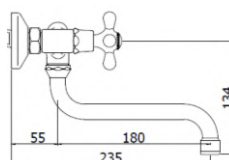

**IRV161..** BATERIA UMYWALKOWA ŚCIENNA

<b>CR</b>	CHROM	<b>500,00</b>
<b>*CO</b>	CHROM/ZŁOTO	<b>600,00</b>
<b>*GF</b>	ZŁOTO	<b>1060,00</b>
<b>*BR</b>	STARE ZŁOTO	<b>880,00</b>



**IRV168..** BATERIA NATRYSKOWA ŚCIENNA (KORPUS)  
**IRV168D..** BATERIA NATRYSKOWA ŚCIENNA (KOMPLETNA)

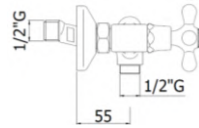

**INDEKS IRV168**

<b>CR</b>	CHROM	<b>440,00</b>
<b>*CO</b>	CHROM/ZŁOTO	<b>520,00</b>
<b>*GF</b>	ZŁOTO	<b>950,00</b>
<b>*BR</b>	STARE ZŁOTO	<b>780,00</b>

**INDEKS IRV168D**

<b>CR</b>	CHROM	<b>650,00</b>
<b>*CO</b>	CHROM/ZŁOTO	<b>760,00</b>
<b>*GF</b>	ZŁOTO	<b>1400,00</b>
<b>*BR</b>	STARE ZŁOTO	<b>1150,00</b>



**IRV180..** BATERIA ZLEWOZMYWAKOWA STOJĄCA

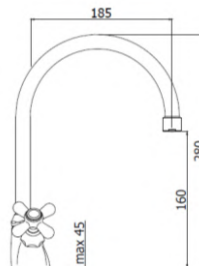

<b>CR</b>	CHROM	<b>430,00</b>
<b>*CO</b>	CHROM/ZŁOTO	<b>520,00</b>
<b>*GF</b>	ZŁOTO	<b>950,00</b>
<b>*BR</b>	STARE ZŁOTO	<b>790,00</b>



**IRV010ZWW..** ZESTAW WANNOWY PODTYNKOWY

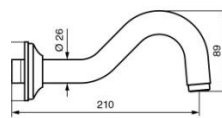

<b>CR</b>	CHROM	<b>1585,00</b>
<b>*CO</b>	CHROM/ZŁOTO	<b>1830,00</b>
<b>*GF</b>	ZŁOTO	<b>3710,00</b>
<b>*BR</b>	STARE ZŁOTO	<b>2605,00</b>



**IRV010ZSCF..** ZESTAW NATRYSKOWY PODTYNKOWY

- SKŁAD ZESTAWU:**  
 - DESZCZOWNICA:  
 (INDEKS F) C00655ø205MM -EMMEVI-  
 - RAMIĘ ŚCIENNE C00684 L-325MM -EMMEVI-  
 -PRZEŁĄCZNIK 2-DROŻNY 121019 -EMMEVI-  
 - ZESTAW 3W1 157 -EMMEVI-



<b>CR</b>	CHROM	<b>2300,00</b>
<b>*CO</b>	CHROM/ZŁOTO	<b>2600,00</b>
<b>*GF</b>	ZŁOTO	<b>5400,00</b>
<b>*BR</b>	STARE ZŁOTO	<b>3730,00</b>



**SKŁAD ZESTAWU:**  
 - DESZCZOWNICA:  
 (INDEKS F) C00655       $\varnothing$ 205MM -EMMEVI-  
 - RAMIĘ ŚCIENNE C00684      L-325MM -EMMEVI-  
 - ZESTAW NATRYSKOWY C02541 -EMMEVI-  
 - PRZYŁĄCZE KĄTOWE C06908 -EMMEVI-



<b>CR</b>	CHROM	<b>2785,00</b>
<b>*CO</b>	CHROM/ZŁOTO	<b>3640,00</b>
<b>*GF</b>	ZŁOTO	<b>6490,00</b>
<b>*BR</b>	STARE ZŁOTO	<b>4635,00</b>

**IRV010ZNF..**      ZESTAW NATRYSKOWY PODTYNKOWY

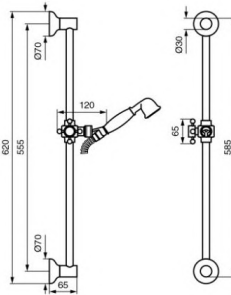

<b>CR</b>	CHROM	<b>580,00</b>
<b>*CO</b>	CHROM/ZŁOTO	<b>1140,00</b>
<b>BR</b>	STARE ZŁOTO	<b>1100,00</b>
<b>*OR</b>	ZŁOTY BŁYSZCZĄCY	<b>1510,00</b>

**C02541..**      ZESTAW NATRYSKOWY **LAGUNA**      -EMMEVI-

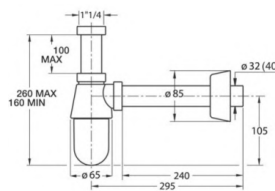
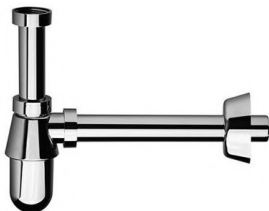

<b>CR</b>	CHROM	<b>85,00</b>
-----------	-------	--------------

**BO0570..**      PÓŁSYFON UMYWALKOWY **THERMO**      -BONOMINI-      ABS+BRASS

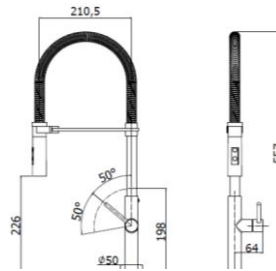

INDEKS CH179CR

CR CHROM 1450,00

**CH179CR..** BATERIA ZLEWOZMYWAKOWA STOJĄCA Z WĘŻEM OPERACYJNYM (SREBRNYM)

**CH179CRNO..** BATERIA ZLEWOZMYWAKOWA STOJĄCA Z WĘŻEM OPERACYJNYM (CZARNYM)

INDEKS CH179CRNO

CRNO CHROM 1500,00

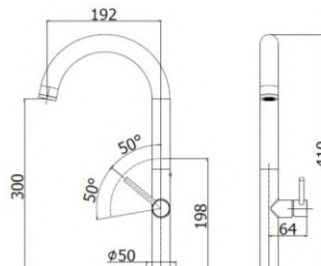

CR CHROM 850,00

**CH180..** BATERIA ZLEWOZMYWAKOWA STOJĄCA

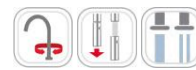
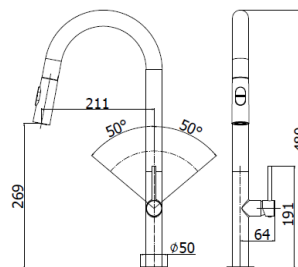

CR CHROM 1000,00

**CH185..** BATERIA ZLEWOZMYWAKOWA STOJĄCA Z WĘŻEM OPERACYJNYM

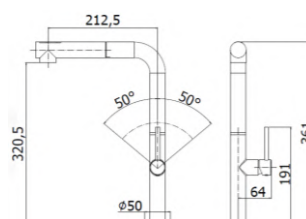

CR CHROM 920,00

**CH985..** BATERIA ZLEWOZMYWAKOWA STOJĄCA Z WĘŻEM OPERACYJNYM



**DR600H..** BATERIA WANNOWA ŚCIENNA (KORPUS)  
**DR610..** BATERIA WANNOWA ŚCIENNA (KOMPLETNA)

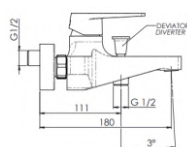

**INDEKS DR600H**

<b>CR</b>	CHROM	570,00
<b>*.FZ</b>	GUNMETAL	1150,00
<b>*FIN.A</b>		920,00
<b>*FIN.B</b>		1150,00

**INDEKS DR610**

<b>CR</b>	CHROM	680,00
<b>*.FZ</b>	GUNMETAL	1360,00
<b>*FIN.A</b>		1100,00
<b>*FIN.B</b>		1360,00



**DR602..** BATERIA PODTYNKOWA 1-DROŻNA

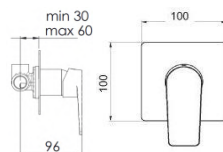

<b>CR</b>	CHROM	365,00
<b>*.FZ</b>	GUNMETAL	730,00
<b>*FIN.A</b>		590,00
<b>*FIN.B</b>		730,00



**DR604B..** BATERIA BIDETOWA STOJĄCA (BEZ KORKA)

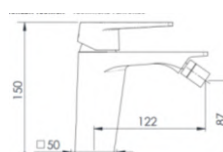

<b>CR</b>	CHROM	495,00
<b>*.FZ</b>	GUNMETAL	960,00
<b>*FIN.A</b>		770,00
<b>*FIN.B</b>		960,00



**DR606..** BATERIA UMYWALKOWA STOJĄCA (BEZ KORKA)

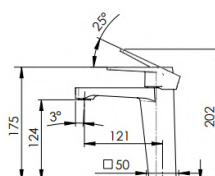

<b>CR</b>	CHROM	495,00
<b>*.FZ</b>	GUNMETAL	960,00
<b>*FIN.A</b>		770,00
<b>*FIN.B</b>		960,00

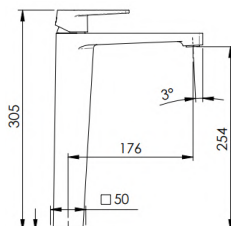

**DR607B..** BATERIA UMYWALKOWA STOJĄCA (BEZ KORKA)

<b>CR</b>	CHROM	<b>920,00</b>
<b>*.FZ</b>	GUNMETAL	<b>1900,00</b>
<b>*FIN.A</b>		<b>1520,00</b>
<b>*FIN.B</b>		<b>1900,00</b>

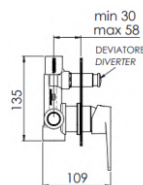

**DR612..** BATERIA PODTYNKOWA 2-DROŻNA

<b>CR</b>	CHROM	<b>600,00</b>
<b>*.FZ</b>	GUNMETAL	<b>1200,00</b>
<b>*FIN.A</b>		<b>970,00</b>
<b>*FIN.B</b>		<b>1200,00</b>

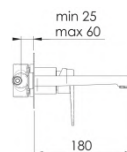

**DR632..** BATERIA UMYWALKOWA PODTYNKOWA

<b>CR</b>	CHROM	<b>1200,00</b>
<b>*.FZ</b>	GUNMETAL	<b>2400,00</b>
<b>*FIN.A</b>		<b>1950,00</b>
<b>*FIN.B</b>		<b>2400,00</b>

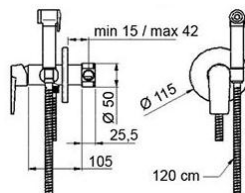

**DR6454DC..** BATERIA BIDETOWA PODTYNKOWA

<b>CR</b>	CHROM	<b>850,00</b>
<b>*.FZ</b>	GUNMETAL	<b>1700,00</b>
<b>*FIN.A</b>		<b>1360,00</b>
<b>*FIN.B</b>		<b>1700,00</b>

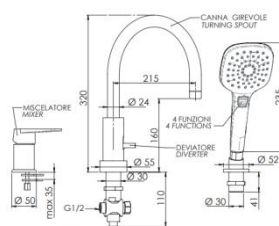

**DR691..** BATERIA WANNOWA 3-OTWOROWA

<b>CR</b>	CHROM	<b>1400,00</b>
<b>*.FZ</b>	GUNMETAL	<b>2800,00</b>
<b>*FIN.A</b>		<b>2250,00</b>
<b>*FIN.B</b>		<b>2800,00</b>





**DR84..**

BATERIA ZLEWOZMYWAKOWA STOJĄCA

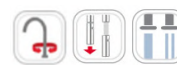
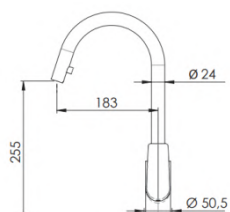

**CR** CHROM  
**\*.FZ** GUNMETAL  
**\*FIN.A**  
**\*FIN.B**

**1100,00**  
**2200,00**  
**1800,00**  
**2200,00**



**DR615Z0..**

ZESTAW NATRYSKOWY PODTYNKOWY

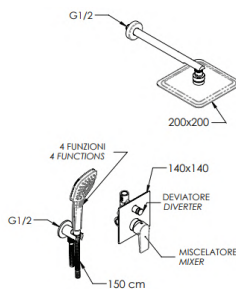

**CR** CHROM  
**\*.FZ** GUNMETAL  
**\*FIN.A**  
**\*FIN.B**

**1650,00**  
**3300,00**  
**2650,00**  
**3300,00**



**A340435..**

ZESTAW NATRYSKOWY

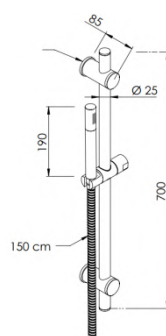

**CR** CHROM  
**\*.FZ** GUNMETAL  
**\*FIN.A**  
**\*FIN.B**

**750,00**  
**1450,00**  
**1170,00**  
**1450,00**



**A735R..**

KOREK UMYWALKOWY UNIWERSALNY **CLICK CLACK**

**CR** CHROM  
**\*.FZ** GUNMETAL  
**\*FIN.A**  
**\*FIN.B**

**80,00**  
**320,00**  
**260,00**  
**320,00**



.15

.14

.NP

.XV.

.DP

.DO



### INDEKS IR600H

CR	CHROM	660,00
*.64	MIEDŹ SZCZOTKOWANA	1060,00
*.DP	ZŁOTY SZCZOTKOWANY	1320,00
*.FZ	GUNMETAL	1320,00
*FIN.A		1060,00
*FIN.B		1320,00



IR600H..

BATERIA WANNOWA ŚCIENNA (KORPUS)

IR610..

BATERIA WANNOWA ŚCIENNA (KOMPLETNA)

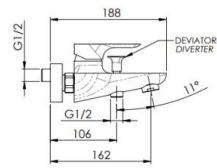

### INDEKS IR610

CR	CHROM	770,00
*.64	MIEDŹ SZCZOTKOWANA	1350,00
*.DP	ZŁOTY SZCZOTKOWANY	1440,00
*.FZ	GUNMETAL	1500,00
*FIN.A		1350,00
*FIN.B		1440,00



IR602..

BATERIA PODTYNKOWA 1-DROŻNA

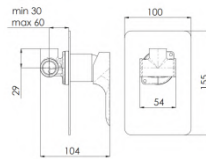

CR	CHROM	385,00
*.64	MIEDŹ SZCZOTKOWANA	620,00
*.DP	ZŁOTY SZCZOTKOWANY	770,00
*.FZ	GUNMETAL	770,00
*FIN.A		620,00
*FIN.B		770,00



IR604B..

BATERIA BIDETOWA STOJĄCA (BEZ KORKA)

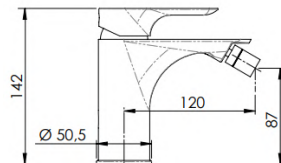

CR	CHROM	530,00
*.64	MIEDŹ SZCZOTKOWANA	860,00
*.DP	ZŁOTY SZCZOTKOWANY	1060,00
*.FZ	GUNMETAL	1060,00
*FIN.A		860,00
*FIN.B		1060,00



IR606..

BATERIA UMYWALKOWA STOJĄCA (BEZ KORKA)

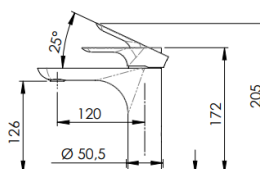

CR	CHROM	530,00
*.64	MIEDŹ SZCZOTKOWANA	860,00
*.DP	ZŁOTY SZCZOTKOWANY	1060,00
*.FZ	GUNMETAL	1060,00
*FIN.A		860,00
*FIN.B		1060,00

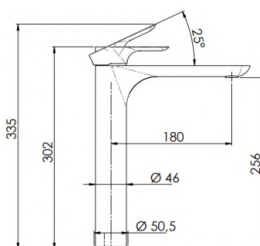

**IR607B..** BATERIA UMYWALKOWA STOJĄCA (BEZ KORKA)

<b>CR</b>	CHROM	<b>860,00</b>
<b>*.64</b>	MIEDŹ SZCZOTKOWANA	<b>1440,00</b>
<b>*.DP</b>	ZŁOTY SZCZOTKOWANY	<b>1730,00</b>
<b>*.FZ</b>	GUNMETAL	<b>1730,00</b>
<b>*FIN.A</b>		<b>1440,00</b>
<b>*FIN.B</b>		<b>1730,00</b>

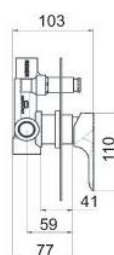

**IR612..** BATERIA PODTYNKOWA 2-DROŻNA

<b>CR</b>	CHROM	<b>610,00</b>
<b>*.64</b>	MIEDŹ SZCZOTKOWANA	<b>980,00</b>
<b>*.DP</b>	ZŁOTY SZCZOTKOWANY	<b>1220,00</b>
<b>*.FZ</b>	GUNMETAL	<b>1220,00</b>
<b>*FIN.A</b>		<b>980,00</b>
<b>*FIN.B</b>		<b>1220,00</b>

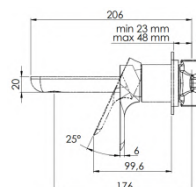

**IR632P..** BATERIA UMYWALKOWA PODTYNKOWA

<b>CR</b>	CHROM	<b>1350,00</b>
<b>*.64</b>	MIEDŹ SZCZOTKOWANA	<b>2200,00</b>
<b>*.DP</b>	ZŁOTY SZCZOTKOWANY	<b>2700,00</b>
<b>*.FZ</b>	GUNMETAL	<b>2700,00</b>
<b>*FIN.A</b>		<b>2200,00</b>
<b>*FIN.B</b>		<b>2700,00</b>

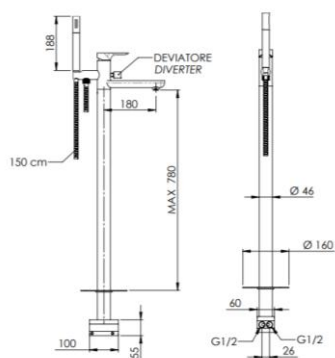

**IR678..** BATERIA WANNOWA WOLNOSTOJĄCA

<b>CR</b>	CHROM	<b>5300,00</b>
<b>*.64</b>	MIEDŹ SZCZOTKOWANA	<b>8500,00</b>
<b>*.DP</b>	ZŁOTY SZCZOTKOWANY	<b>10600,00</b>
<b>*.FZ</b>	GUNMETAL	<b>1500,00</b>
<b>*FIN.A</b>		<b>8500,00</b>
<b>*FIN.B</b>		<b>10600,00</b>

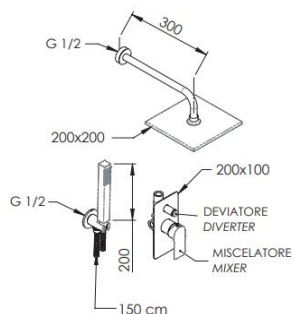

<b>CR</b>	CHROM	<b>1700,00</b>
<b>*.64</b>	MIEDŹ SZCZOTKOWANA	<b>2750,00</b>
<b>*.DP</b>	ZŁOTY SZCZOTKOWANY	<b>3400,00</b>
<b>*.FZ</b>	GUNMETAL	<b>3400,00</b>
<b>*FIN.A</b>		<b>2750,00</b>
<b>*FIN.B</b>		<b>3400,00</b>

**IR015ZSC1A..**

ZESTAW NATRYSKOWY PODTYNKOWY

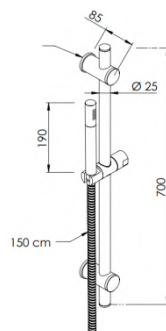

<b>CR</b>	CHROM	<b>750,00</b>
<b>.64</b>	MIEDŹ SZCZOTKOWANA	<b>1170,00</b>
<b>.DP</b>	ZŁOTY SZCZOTKOWANY	<b>1450,00</b>
<b>*.FZ</b>	GUNMETAL	<b>1450,00</b>
<b>*FIN.A</b>		<b>1170,00</b>
<b>*FIN.B</b>		<b>1450,00</b>

**A340435..**

ZESTAW NATRYSKOWY



**A735R..**

KOREK UMYWALKOWY UNIWERSALNY **CLICK CLACK**

<b>CR</b>	CHROM	<b>80,00</b>
<b>.64</b>	MIEDŹ SZCZOTKOWANA	<b>260,00</b>
<b>.DP</b>	ZŁOTY SZCZOTKOWANY	<b>320,00</b>
<b>*.FZ</b>	GUNMETAL	<b>320,00</b>
<b>*FIN.A</b>		<b>260,00</b>
<b>*FIN.B</b>		<b>320,00</b>

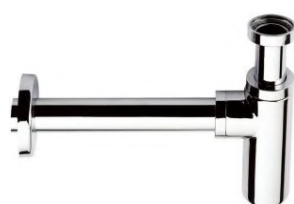

**A750..**

PÓŁSYFON UMYWALKOWY METALOWY

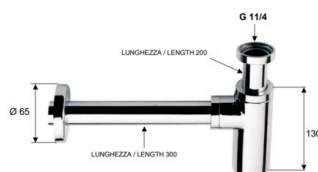

<b>CR</b>	CHROM	<b>320,00</b>
<b>.64</b>	MIEDŹ SZCZOTKOWANA	<b>500,00</b>
<b>.DP</b>	ZŁOTY SZCZOTKOWANY	<b>620,00</b>
<b>*.FZ</b>	GUNMETAL	<b>620,00</b>
<b>*FIN.A</b>		<b>500,00</b>
<b>*FIN.B</b>		<b>620,00</b>



### INDEKS ER600H

<b>CR</b>	CHROM	<b>520,00</b>
<b>*.15</b>	CZARNY MAT	<b>840,00</b>
<b>*.14</b>	BIAŁY MAT	<b>840,00</b>
<b>*.NP</b>	STAL SZCZOTKOWANA	<b>840,00</b>
<b>*.64</b>	MIEDŹ SZCZOTKOWANA	<b>840,00</b>
<b>*.DP</b>	ZŁOTY SZCZOTKOWANY	<b>1040,00</b>



**ER600H..**  
**ER610..**

BATERIA WANNOWA ŚCIENNA (KORPUS)  
BATERIA WANNOWA ŚCIENNA (KOMPLETNA)

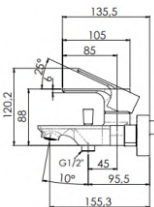

### INDEKS ER610

<b>CR</b>	CHROM	<b>610,00</b>
<b>*.15</b>	CZARNY MAT	<b>980,00</b>
<b>*.14</b>	BIAŁY MAT	<b>980,00</b>
<b>*.NP</b>	STAL SZCZOTKOWANA	<b>980,00</b>
<b>*.64</b>	MIEDŹ SZCZOTKOWANA	<b>980,00</b>
<b>*.DP</b>	ZŁOTY SZCZOTKOWANY	<b>1220,00</b>



**ER604B..**

BATERIA BIDETOWA STOJĄCA (BEZ KORKA)

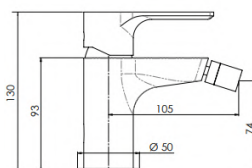

<b>CR</b>	CHROM	<b>345,00</b>
<b>*.15</b>	CZARNY MAT	<b>560,00</b>
<b>*.14</b>	BIAŁY MAT	<b>560,00</b>
<b>*.NP</b>	STAL SZCZOTKOWANA	<b>560,00</b>
<b>*.64</b>	MIEDŹ SZCZOTKOWANA	<b>560,00</b>
<b>*.DP</b>	ZŁOTY SZCZOTKOWANY	<b>690,00</b>



**ER606..**

BATERIA UMYWALKOWA STOJĄCA (BEZ KORKA)

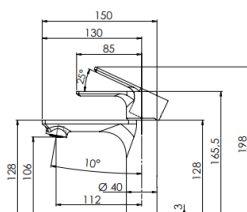

<b>CR</b>	CHROM	<b>345,00</b>
<b>*.15</b>	CZARNY MAT	<b>560,00</b>
<b>*.14</b>	BIAŁY MAT	<b>560,00</b>
<b>*.NP</b>	STAL SZCZOTKOWANA	<b>560,00</b>
<b>*.64</b>	MIEDŹ SZCZOTKOWANA	<b>560,00</b>
<b>*.DP</b>	ZŁOTY SZCZOTKOWANY	<b>690,00</b>

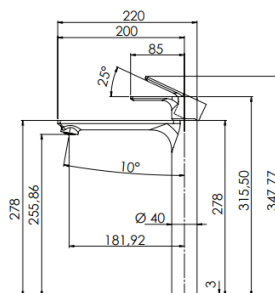

**ER607B..** BATERIA UMYWALKOWA WYSOKA (BEZ KORKA)

<b>CR</b>	CHROM	<b>850,00</b>
<b>*.15</b>	CZARNY MAT	<b>1400,00</b>
<b>*.14</b>	BIAŁY MAT	<b>1400,00</b>
<b>*.NP</b>	STAL SZCZOTKOWANA	<b>1400,00</b>
<b>*.64</b>	MIEDŹ SZCZOTKOWANA	<b>1400,00</b>
<b>*.DP</b>	ZŁOTY SZCZOTKOWANY	<b>1700,00</b>

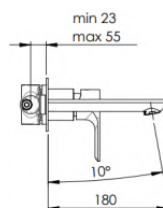

**ER632P..** BATERIA UMYWALKOWA PODTYNKOWA

<b>CR</b>	CHROM	<b>1350,00</b>
<b>*.15</b>	CZARNY MAT	<b>2200,00</b>
<b>*.14</b>	BIAŁY MAT	<b>2200,00</b>
<b>*.NP</b>	STAL SZCZOTKOWANA	<b>2200,00</b>
<b>*.64</b>	MIEDŹ SZCZOTKOWANA	<b>2200,00</b>
<b>*.DP</b>	ZŁOTY SZCZOTKOWANY	<b>2700,00</b>

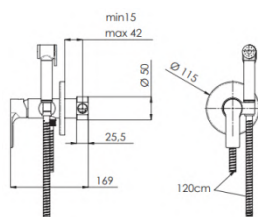

**ER6454DC..** BATERIA BIDETOWA PODTYNKOWA

<b>CR</b>	CHROM	<b>850,00</b>
<b>*.15</b>	CZARNY MAT	<b>1360,00</b>
<b>*.14</b>	BIAŁY MAT	<b>1360,00</b>
<b>*.NP</b>	STAL SZCZOTKOWANA	<b>1360,00</b>
<b>*.64</b>	MIEDŹ SZCZOTKOWANA	<b>1360,00</b>
<b>*.DP</b>	ZŁOTY SZCZOTKOWANY	<b>1700,00</b>

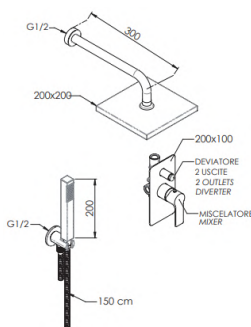

**ER015ZSC1A..** ZESTAW NATRYSKOWY PODTYNKOWY

<b>CR</b>	CHROM	<b>1700,00</b>
<b>*.15</b>	CZARNY MAT	<b>2750,00</b>
<b>*.14</b>	BIAŁY MAT	<b>2750,00</b>
<b>*.NP</b>	STAL SZCZOTKOWANA	<b>2750,00</b>
<b>*.64</b>	MIEDŹ SZCZOTKOWANA	<b>2750,00</b>
<b>*.DP</b>	ZŁOTY SZCZOTKOWANY	<b>3400,00</b>



**ER015ZWW..** ZESTAW WANNOWY PODTYNKOWY



<b>CR</b>	CHROM	<b>1600,00</b>
<b>*.15</b>	CZARNY MAT	<b>2600,00</b>
<b>*.14</b>	BIAŁY MAT	<b>2600,00</b>
<b>*.NP</b>	STAL SZCZOTKOWANA	<b>2600,00</b>
<b>*.64</b>	MIEDŹ SZCZOTKOWANA	<b>2600,00</b>
<b>*.DP</b>	ZŁOTY SZCZOTKOWANY	<b>3200,00</b>

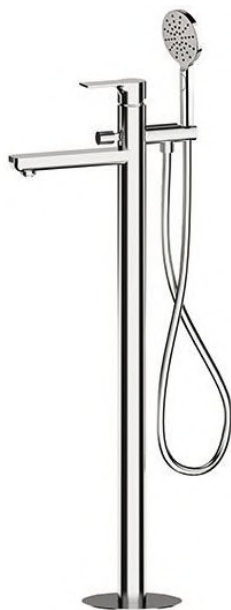

**ER678..** BATERIA WANNOWA WOLNOSTOJĄCA

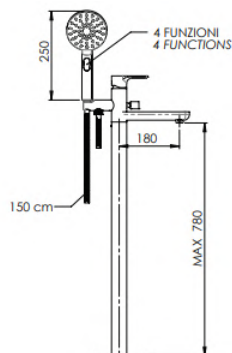

<b>*CR</b>	CHROM	<b>5250,00</b>
<b>*.15</b>	CZARNY MAT	<b>8400,00</b>
<b>*.14</b>	BIAŁY MAT	<b>8400,00</b>
<b>*.NP</b>	STAL SZCZOTKOWANA	<b>8400,00</b>
<b>*.64</b>	MIEDŹ SZCZOTKOWANA	<b>8400,00</b>
<b>*.DP</b>	ZŁOTY SZCZOTKOWANY	<b>10500,00</b>



**A340435..** ZESTAW NATRYSKOWY

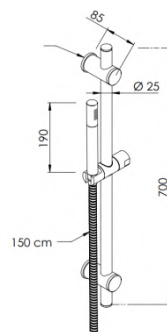

<b>CR</b>	CHROM	<b>750,00</b>
<b>*.15</b>	CZARNY MAT	<b>1170,00</b>
<b>*.14</b>	BIAŁY MAT	<b>1170,00</b>
<b>*.NP</b>	STAL SZCZOTKOWANA	<b>1170,00</b>
<b>*.64</b>	MIEDŹ SZCZOTKOWANA	<b>1170,00</b>
<b>*.DP</b>	ZŁOTY SZCZOTKOWANY	<b>1450,00</b>



**A735R..** KOREK UMYWALKOWY UNIWERSALNY **CLICK CLACK**

<b>CR</b>	CHROM	<b>80,00</b>
<b>*.15</b>	CZARNY MAT	<b>260,00</b>
<b>*.14</b>	BIAŁY MAT	<b>260,00</b>
<b>*.NP</b>	STAL SZCZOTKOWANA	<b>260,00</b>
<b>*.64</b>	MIEDŹ SZCZOTKOWANA	<b>260,00</b>
<b>*.DP</b>	ZŁOTY SZCZOTKOWANY	<b>320,00</b>



**OM600H..**

BATERIA WANNOWA ŚCIENNA (KORPUS)

**OM610..**

BATERIA WANNOWA ŚCIENNA (KOMPLETNA)

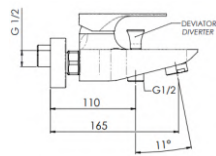

INDEKS **OM600H**

<b>CR</b>	CHROM	<b>530,00</b>
<b>*FIN.A</b>		<b>875,00</b>
<b>*FIN.B</b>		<b>1080,00</b>

INDEKS **OM610**

<b>CR</b>	CHROM	<b>640,00</b>
<b>*FIN.A</b>		<b>1040,00</b>
<b>*FIN.B</b>		<b>1300,00</b>



**OM602..**

BATERIA PODTYNKOWA 1-DROŻNA

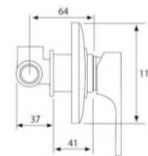

<b>CR</b>	CHROM	<b>225,00</b>
<b>*FIN.A</b>		<b>330,00</b>
<b>*FIN.B</b>		<b>410,00</b>



**OM604B..**

BATERIA BIDETOWA STOJĄCA (BEZ KORKA)

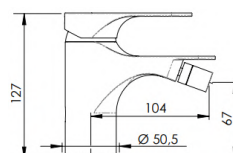

<b>CR</b>	CHROM	<b>380,00</b>
<b>*FIN.A</b>		<b>610,00</b>
<b>*FIN.B</b>		<b>760,00</b>



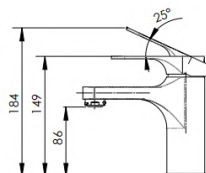

**OM606..** BATERIA UMYWALKOWA STOJĄCA (BEZ KORKA)

**CR** CHROM 380,00  
**\*FIN.A** 610,00  
**\*FIN.B** 760,00

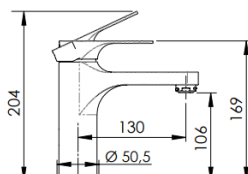

**OM607B..** BATERIA UMYWALKOWA XL STOJĄCA (BEZ KORKA)

**CR** CHROM 435,00  
**\*FIN.A** 695,00  
**\*FIN.B** 870,00

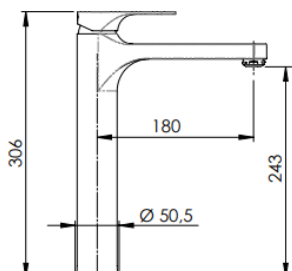

**OM607XB..** BATERIA UMYWALKOWA WYSOKA (BEZ KORKA)

**CR** CHROM 815,00  
**\*FIN.A** 1305,00  
**\*FIN.B** 1650,00

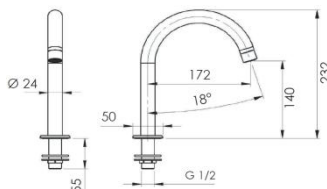

**OM655..** BATERIA UMYWALKOWA 2-OTWOROWA

**CR** CHROM 760,00  
**\*FIN.A** 1230,00  
**\*FIN.B** 1550,00



**OM609S..** BATERIA UMYWALKOWA ŚCIENNA L-20cm

**CR** CHROM 490,00  
**\*FIN.A** 780,00  
**\*FIN.B** 970,00

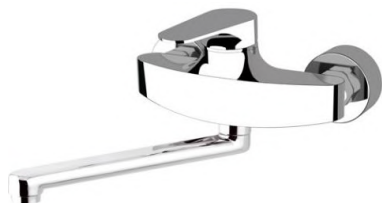

**OM609T..** BATERIA UMYWALKOWA ŚCIENNA L-20CM

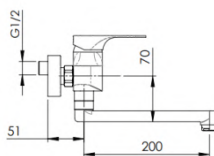

**CR** CHROM 490,00  
**\*FIN.A** 780,00  
**\*FIN.B** 970,00



**OM611..** BATERIA NATRYSKOWA ŚCIENNA (KORPUS)  
**OM611A..** BATERIA NATRYSKOWA ŚCIENNA (KOMPLETNA)

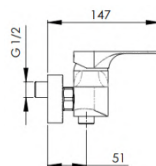

**INDEKS OM611**  
**CR** CHROM 400,00  
**\*FIN.A** 650,00  
**\*FIN.B** 800,00

**INDEKS OM611A**  
**CR** CHROM 520,00  
**\*FIN.A** 840,00  
**\*FIN.B** 1000,00



**OM614T..** BATERIA ZLEWOZMYWAKOWA 45° Z RUCHOMĄ WYLEWKĄ  
**OM614TC..** BATERIA UMYWALKOWA 45° Z RUCHOMĄ WYLEWKĄ

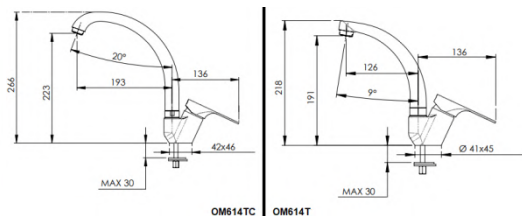

**CR** CHROM 380,00  
**\*FIN.A** 560,00  
**\*FIN.B** 700,00



**OM624..** BATERIA WANNOWA ŚCIENNA Z WYLEWKĄ L-30CM

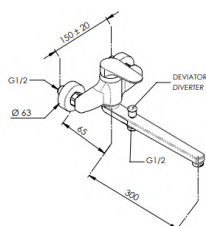

**CR** CHROM 780,00  
**\*FIN.A** 1250,00  
**\*FIN.B** 1520,00

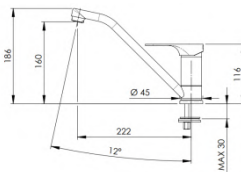

**CR**  
**\*FIN.A**  
**\*FIN.B**

CHROM

**340,00**  
**540,00**  
**680,00**

**OM629..** BATERIA ZLEWOZMYWAKOWA STOJĄCA



**CR**  
**\*FIN.A**  
**\*FIN.B**

CHROM

**570,00**  
**950,00**  
**1140,00**

**OM633..** BATERIA ZLEWOZMYWAKOWA ŚCIENNA

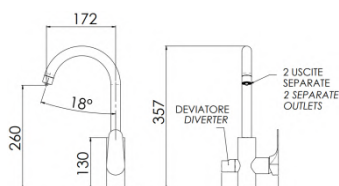

**\*CR**  
**\*FIN.A**  
**\*FIN.B**

CHROM

**1390,00**  
**2225,00**  
**2780,00**

**OM679DW..** BATERIA ZLEWOZMYWAKOWA DO WODY FILTROWANEJ

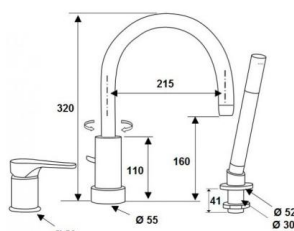

**CR**  
**\*FIN.A**  
**\*FIN.B**

CHROM

**1300,00**  
**2200,00**  
**2750,00**

**OM691..** BATERIA WANNOWA 3-OTWOROWA

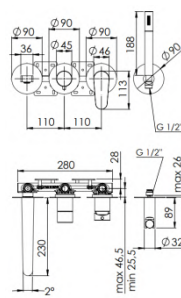

**CR**  
**\*FIN.A**  
**\*FIN.B**

CHROM

**2900,00**  
**4650,00**  
**5800,00**

**OM710D2P..** BATERIA WANNOWA PODTYNKOWA L-216MM

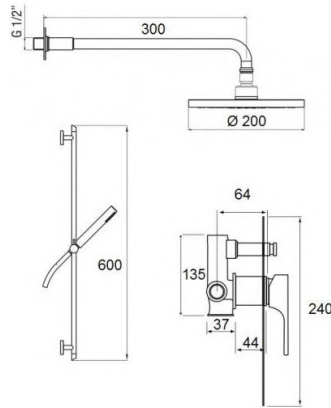

**CR**  
**\*FIN.A**  
**\*FIN.B**

CHROM

**1400,00**  
**3650,00**  
**4550,00**

**OM614Z..**

ZESTAW NATRYSKOWY PODTYNKOWY

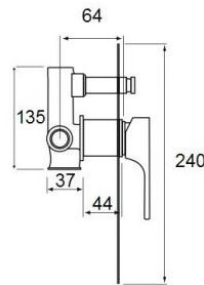

**CR**  
**\*FIN.A**  
**\*FIN.B**

CHROM

**1250,00**  
**2900,00**  
**3600,00**

**OM615Z..**

ZESTAW NATRYSKOWY PODTYNKOWY



**CR**  
**CHROM**

**2600,00**

**OM636..**

KOLUMNA WANNOWA **OMEGA**

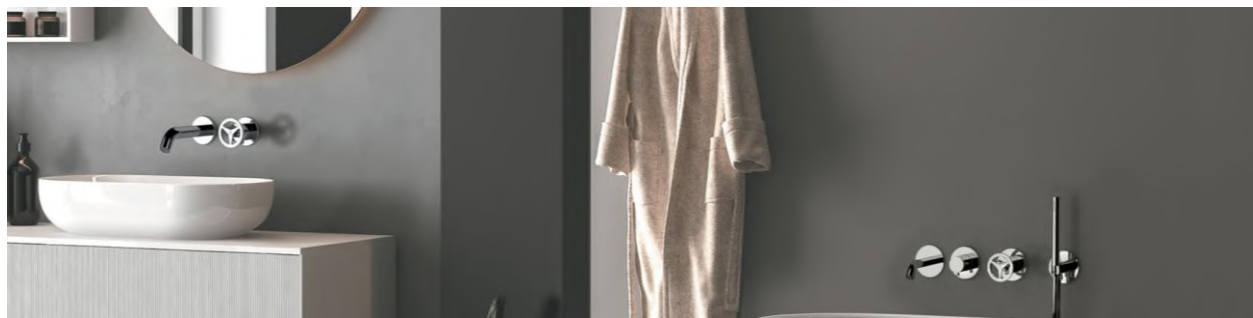

**CH606..** BATERIA UMYWALKOWA STOJĄCA (BEZ KORKA)

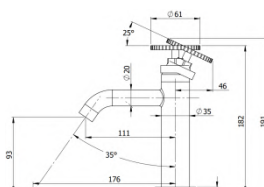

<b>*CR</b>	CHROM	<b>990,00</b>
<b>*.64</b>	MIEDŹ SZCZOTKOWANA	<b>1600,00</b>
<b>*.DP</b>	ZŁOTY SZCZOTKOWANY	<b>1990,00</b>
<b>*.FZ</b>	GUNMETAL	<b>1990,00</b>
<b>*FIN.A</b>		<b>1600,00</b>
<b>*FIN.B</b>		<b>1990,00</b>



**CH607B..** BATERIA UMYWALKOWA WYSOKA (BEZ KORKA)

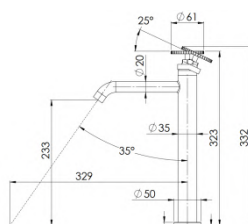

<b>*CR</b>	CHROM	<b>1150,00</b>
<b>*.64</b>	MIEDŹ SZCZOTKOWANA	<b>1800,00</b>
<b>*.DP</b>	ZŁOTY SZCZOTKOWANY	<b>2250,00</b>
<b>*.FZ</b>	GUNMETAL	<b>2250,00</b>
<b>*FIN.A</b>		<b>1800,00</b>
<b>*FIN.B</b>		<b>2250,00</b>



**CH632P..** BATERIA UMYWALKOWA PODTYNKOWA (ZINTEGROWANA)

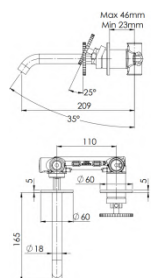

<b>*CR</b>	CHROM	<b>1660,00</b>
<b>*.64</b>	MIEDŹ SZCZOTKOWANA	<b>2650,00</b>
<b>*.DP</b>	ZŁOTY SZCZOTKOWANY	<b>3300,00</b>
<b>*.FZ</b>	GUNMETAL	<b>3300,00</b>
<b>*FIN.A</b>		<b>2650,00</b>
<b>*FIN.B</b>		<b>3300,00</b>



**CH6454DC..** BATERIA BIDCZOWA PODTYNKOWA

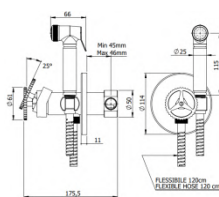

<b>*CR</b>	CHROM	<b>1200,00</b>
<b>*.64</b>	MIEDŹ SZCZOTKOWANA	<b>1860,00</b>
<b>*.DP</b>	ZŁOTY SZCZOTKOWANY	<b>2350,00</b>
<b>*.FZ</b>	GUNMETAL	<b>2350,00</b>
<b>*FIN.A</b>		<b>1860,00</b>
<b>*FIN.B</b>		<b>2350,00</b>



**CH625ZWW..** ZESTAW WANNOWY PODTYNKOWY L-165MM

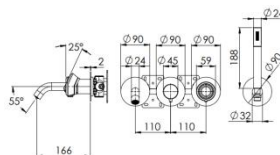

<b>*CR</b>	CHROM	<b>2950,00</b>
<b>*.64</b>	MIEDŹ SZCZOTKOWANA	<b>4720,00</b>
<b>*.DP</b>	ZŁOTY SZCZOTKOWANY	<b>5900,00</b>
<b>*.FZ</b>	GUNMETAL	<b>5900,00</b>
<b>*FIN.A</b>		<b>4720,00</b>
<b>*FIN.B</b>		<b>5900,00</b>



**CH625Z0..** ZESTAW NATRYSKOWY PODTYNKOWY

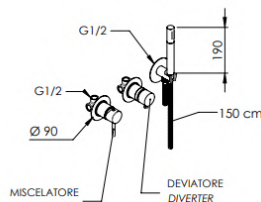

<b>*CR</b>	CHROM	<b>3100,00</b>
<b>*.64</b>	MIEDŹ SZCZOTKOWANA	<b>5000,00</b>
<b>*.DP</b>	ZŁOTY SZCZOTKOWANY	<b>6200,00</b>
<b>*.FZ</b>	GUNMETAL	<b>6200,00</b>
<b>*FIN.A</b>		<b>5000,00</b>
<b>*FIN.B</b>		<b>6200,00</b>



**A735R..** KOREK UMYWALKOWY UNIWERSALNY **CLICK CLACK**

<b>CR</b>	CHROM	<b>80,00</b>
<b>.64</b>	MIEDŹ SZCZOTKOWANA	<b>260,00</b>
<b>.DP</b>	ZŁOTY SZCZOTKOWANY	<b>320,00</b>
<b>*.FZ</b>	GUNMETAL	<b>320,00</b>
<b>*FIN.A</b>		<b>260,00</b>
<b>*FIN.B</b>		<b>320,00</b>



**A750..** PÓŁSYFON UMYWALKOWY METALOWY

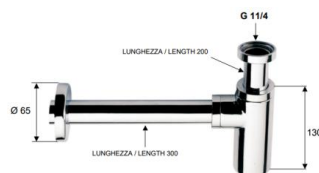

<b>CR</b>	CHROM	<b>320,00</b>
<b>.64</b>	MIEDŹ SZCZOTKOWANA	<b>500,00</b>
<b>.DP</b>	ZŁOTY SZCZOTKOWANY	<b>620,00</b>
<b>*.FZ</b>	GUNMETAL	<b>620,00</b>
<b>*FIN.A</b>		<b>500,00</b>
<b>*FIN.B</b>		<b>620,00</b>

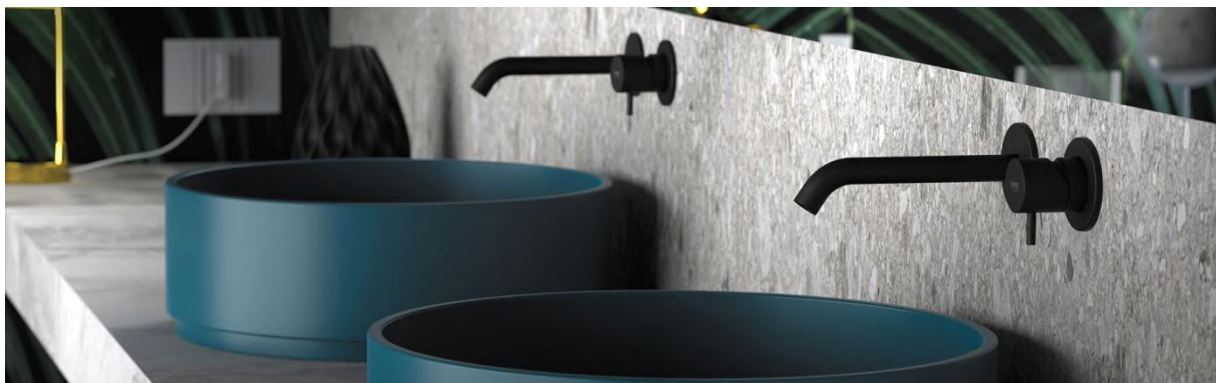

**TX600H..**  
**TX610..**

BATERIA WANNOWA ŚCIENNA (KORPUS)  
BATERIA WANNOWA ŚCIENNA (KOMPLETNA)

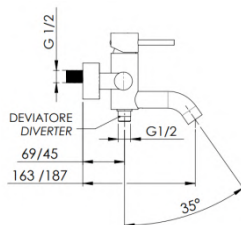

**INDEKS TX600H**

<b>*CR</b>	CHROM	<b>980,00</b>
<b>.64</b>	MIEDŹ SZCZOTKOWANA	<b>1560,00</b>
<b>.DP</b>	ZŁOTY SZCZOTKOWANY	<b>1950,00</b>
<b>*.FZ</b>	GUNMETAL	<b>1950,00</b>
<b>*FIN.A</b>		<b>1560,00</b>
<b>*FIN.B</b>		<b>1950,00</b>

**INDEKS TX610**

<b>*CR</b>	CHROM	<b>1130,00</b>
<b>.64</b>	MIEDŹ SZCZOTKOWANA	<b>1800,00</b>
<b>.DP</b>	ZŁOTY SZCZOTKOWANY	<b>2250,00</b>
<b>*.FZ</b>	GUNMETAL	<b>2250,00</b>
<b>*FIN.A</b>		<b>1800,00</b>
<b>*FIN.B</b>		<b>2250,00</b>



**TX602..**

BATERIA PODTYNKOWA 1-DROŻNA

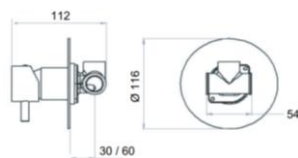

<b>*CR</b>	CHROM	<b>430,00</b>
<b>.64</b>	MIEDŹ SZCZOTKOWANA	<b>680,00</b>
<b>.DP</b>	ZŁOTY SZCZOTKOWANY	<b>850,00</b>
<b>*.FZ</b>	GUNMETAL	<b>850,00</b>
<b>*FIN.A</b>		<b>680,00</b>
<b>*FIN.B</b>		<b>850,00</b>



**TX604B..**

BATERIA BIDETOWA STOJĄCA (BEZ KORKA)

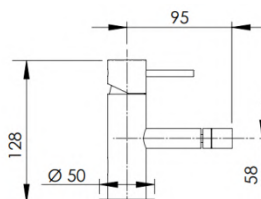

<b>*CR</b>	CHROM	<b>620,00</b>
<b>.64</b>	MIEDŹ SZCZOTKOWANA	<b>995,00</b>
<b>.DP</b>	ZŁOTY SZCZOTKOWANY	<b>1240,00</b>
<b>*.FZ</b>	GUNMETAL	<b>1240,00</b>
<b>*FIN.A</b>		<b>995,00</b>
<b>*FIN.B</b>		<b>1240,00</b>

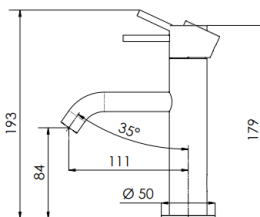

**TX606..** BATERIA UMYWALKOWA STOJĄCA (BEZ KORKA)

<b>*CR</b>	CHROM	<b>620,00</b>
<b>.64</b>	MIEDŹ SZCZOTKOWANA	<b>995,00</b>
<b>.DP</b>	ZŁOTY SZCZOTKOWANY	<b>1240,00</b>
<b>*.FZ</b>	GUNMETAL	<b>1240,00</b>
<b>*FIN.A</b>		<b>995,00</b>
<b>*FIN.B</b>		<b>1240,00</b>

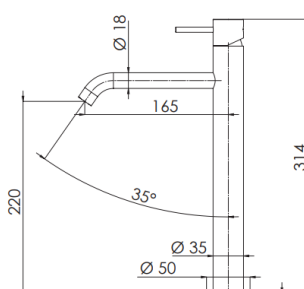

**TX607B..** BATERIA UMYWALKOWA WYSOKA (BEZ KORKA)

<b>*CR</b>	CHROM	<b>780,00</b>
<b>.64</b>	MIEDŹ SZCZOTKOWANA	<b>1250,00</b>
<b>.DP</b>	ZŁOTY SZCZOTKOWANY	<b>1550,00</b>
<b>*.FZ</b>	GUNMETAL	<b>1550,00</b>
<b>*FIN.A</b>		<b>1250,00</b>
<b>*FIN.B</b>		<b>1550,00</b>

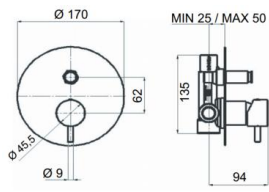

**TX612..** BATERIA PODTYNKOWA 2-DROŻNA

<b>*CR</b>	CHROM	<b>790,00</b>
<b>.64</b>	MIEDŹ SZCZOTKOWANA	<b>1260,00</b>
<b>.DP</b>	ZŁOTY SZCZOTKOWANY	<b>1600,00</b>
<b>*.FZ</b>	GUNMETAL	<b>1600,00</b>
<b>*FIN.A</b>		<b>1260,00</b>
<b>*FIN.B</b>		<b>1600,00</b>

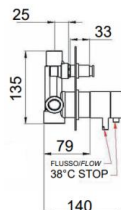

**ST20612..** BATERIA PODTYNKOWA TERMOSTATYCZNA 2-DROŻNA

<b>*CR</b>	CHROM	<b>1150,00</b>
<b>.64</b>	MIEDŹ SZCZOTKOWANA	<b>1850,00</b>
<b>.DP</b>	ZŁOTY SZCZOTKOWANY	<b>2300,00</b>
<b>*.FZ</b>	GUNMETAL	<b>2300,00</b>
<b>*FIN.A</b>		<b>1850,00</b>
<b>*FIN.B</b>		<b>2300,00</b>

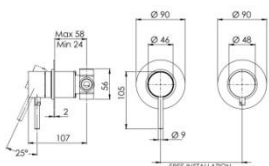

**TX625..** BATERIA PODTYNKOWA 2-DROŻNA

**TXT625..** BATERIA PODTYNKOWA 2-DROŻNA **TERMOSTAT**

<b>INDEKS TX625</b>		
<b>*CR</b>	CHROM	<b>1280,00</b>
<b>.64</b>	MIEDŹ SZCZOTKOWANA	<b>2050,00</b>
<b>.DP</b>	ZŁOTY SZCZOTKOWANY	<b>2550,00</b>
<b>*.FZ</b>	GUNMETAL	<b>2550,00</b>
<b>*FIN.A</b>		<b>2050,00</b>
<b>*FIN.B</b>		<b>2550,00</b>

<b>INDEKS TXT625</b>		
<b>*CR</b>	CHROM	<b>1800,00</b>
<b>.64</b>	MIEDŹ SZCZOTKOWANA	<b>2850,00</b>
<b>.DP</b>	ZŁOTY SZCZOTKOWANY	<b>3550,00</b>
<b>*.FZ</b>	GUNMETAL	<b>3550,00</b>
<b>*FIN.A</b>		<b>2850,00</b>
<b>*FIN.B</b>		<b>3550,00</b>





**TX612D3..**

BATERIA PODTYNKOWA 3-DROŻNA

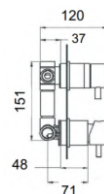

<b>*CR</b>	CHROM	<b>1300,00</b>
<b>.64</b>	MIEDŹ SZCZOTKOWANA	<b>2050,00</b>
<b>.DP</b>	ZŁOTY SZCZOTKOWANY	<b>2600,00</b>
<b>*.FZ</b>	GUNMETAL	<b>2600,00</b>
<b>*FIN.A</b>		<b>2050,00</b>
<b>*FIN.B</b>		<b>2600,00</b>



**TX632P..**

BATERIA UMYWALKOWA PODTYNKOWA (ZINTEGROWANA)

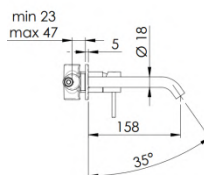

<b>*CR</b>	CHROM	<b>1230,00</b>
<b>.64</b>	MIEDŹ SZCZOTKOWANA	<b>1970,00</b>
<b>.DP</b>	ZŁOTY SZCZOTKOWANY	<b>2450,00</b>
<b>*.FZ</b>	GUNMETAL	<b>2450,00</b>
<b>*FIN.A</b>		<b>1970,00</b>
<b>*FIN.B</b>		<b>2450,00</b>



**TX6454DC..**

BATERIA BIDETOWA PODTYNKOWA

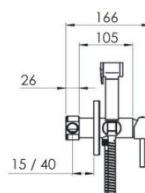



<b>*CR</b>	CHROM	<b>850,00</b>
<b>.64</b>	MIEDŹ SZCZOTKOWANA	<b>1210,00</b>
<b>.DP</b>	ZŁOTY SZCZOTKOWANY	<b>1510,00</b>
<b>*.FZ</b>	GUNMETAL	<b>1510,00</b>
<b>*FIN.A</b>		<b>1210,00</b>
<b>*FIN.B</b>		<b>1510,00</b>

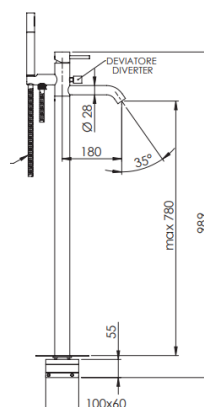

**TX678..**

BATERIA WANNOWA WOLNOSTOJĄCA (KOMPLETNA)



		
		
<b>*CR</b>	CHROM	<b>4620,00</b>
<b>*.64</b>	MIEDŹ SZCZOTKOWANA	<b>7400,00</b>
<b>.DP</b>	ZŁOTY SZCZOTKOWANY	<b>9250,00</b>
<b>*.FZ</b>	GUNMETAL	<b>9250,00</b>
<b>*FIN.A</b>		<b>7400,00</b>
<b>*FIN.B</b>		<b>9250,00</b>

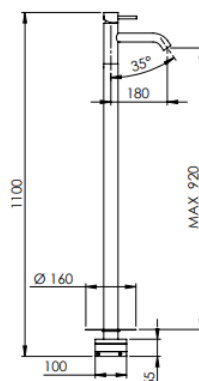
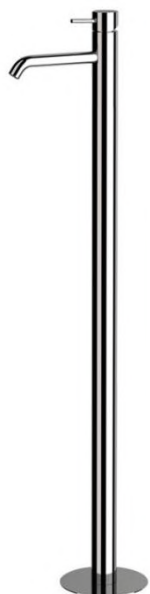

**TX688..** BATERIA UMYWALKOWA WOLNOSTOJĄCA (KOMPLETNA)

*CR	CHROM	4000,00
*.64	MIEDŹ SZCZOTKOWANA	6400,00
*.DP	ZŁOTY SZCZOTKOWANY	8000,00
*.FZ	GUNMETAL	8000,00
*FIN.A		6400,00
*FIN.B		8000,00

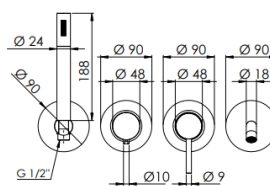

**TX625ZWW..** ZESTAW WANNOWY PODTYNKOWY L-165MM

CR	CHROM	2200,00
.64	MIEDŹ SZCZOTKOWANA	3400,00
.DP	ZŁOTY SZCZOTKOWANY	4300,00
*.FZ	GUNMETAL	4300,00
*FIN.A		3400,00
*FIN.B		4300,00

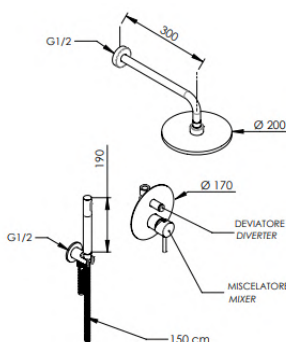

**TX61520..** ZESTAW NATRYSKOWY PODTYNKOWY

CR	CHROM	1750,00
.64	MIEDŹ SZCZOTKOWANA	2800,00
.DP	ZŁOTY SZCZOTKOWANY	3500,00
*.FZ	GUNMETAL	3500,00
*FIN.A		2800,00
*FIN.B		3500,00



**TX625ZO..** ZESTAW NATRYSKOWY PODTYNKOWY

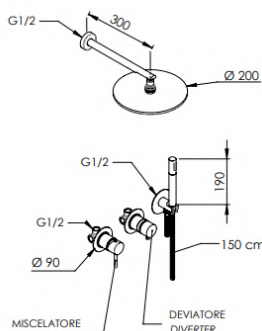

<b>CR</b>	CHROM	<b>2400,00</b>
<b>.64</b>	MIEDŹ SZCZOTKOWANA	<b>3400,00</b>
<b>.DP</b>	ZŁOTY SZCZOTKOWANY	<b>4400,00</b>
<b>*.FZ</b>	GUNMETAL	<b>4400,00</b>
<b>*FIN.A</b>		<b>3400,00</b>
<b>*FIN.B</b>		<b>4400,00</b>



**XF636A3MP7820..** KOLUMNA NATRYSKOWA TERMOSTATYCZNA



<b>CR</b>	CHROM	<b>3000,00</b>
<b>.64</b>	MIEDŹ SZCZOTKOWANA	<b>5100,00</b>
<b>.DP</b>	ZŁOTY SZCZOTKOWANY	<b>6000,00</b>
<b>*.FZ</b>	GUNMETAL	<b>6000,00</b>
<b>*FIN.A</b>		<b>5100,00</b>
<b>*FIN.B</b>		<b>6000,00</b>



**A340435..** ZESTAW NATRYSKOWY

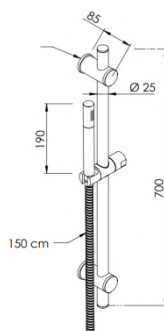

<b>CR</b>	CHROM	<b>750,00</b>
<b>.64</b>	MIEDŹ SZCZOTKOWANA	<b>1170,00</b>
<b>.DP</b>	ZŁOTY SZCZOTKOWANY	<b>1450,00</b>
<b>*.FZ</b>	GUNMETAL	<b>1450,00</b>
<b>*FIN.A</b>		<b>1170,00</b>
<b>*FIN.B</b>		<b>1450,00</b>



**A546435..**

ZESTAW 3W1

**Tokyo**

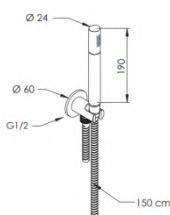

<b>CR</b>	CHROM	<b>340,00</b>
<b>.64</b>	MIEDŹ SZCZOTKOWANA	<b>540,00</b>
<b>.DP</b>	ZŁOTY SZCZOTKOWANY	<b>670,00</b>
<b>*.FZ</b>	GUNMETAL	<b>670,00</b>
<b>*FIN.A</b>		<b>540,00</b>
<b>*FIN.B</b>		<b>670,00</b>



**A525..**

PRZYŁĄCZE KĄTOWE METALOWE

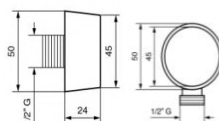

<b>CR</b>	CHROM	<b>70,00</b>
<b>.64</b>	MIEDŹ SZCZOTKOWANA	<b>115,00</b>
<b>.DP</b>	ZŁOTY SZCZOTKOWANY	<b>140,00</b>
<b>*.FZ</b>	GUNMETAL	<b>140,00</b>
<b>*FIN.A</b>		<b>115,00</b>
<b>*FIN.B</b>		<b>140,00</b>



**TK4704..**

WYLEWKA ŚCIENNA TOKYO L-165MM

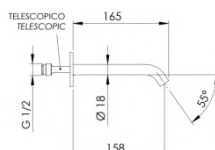

<b>CR</b>	CHROM	<b>490,00</b>
<b>.64</b>	MIEDŹ SZCZOTKOWANA	<b>780,00</b>
<b>.DP</b>	ZŁOTY SZCZOTKOWANY	<b>970,00</b>
<b>*.FZ</b>	GUNMETAL	<b>970,00</b>
<b>*FIN.A</b>		<b>780,00</b>
<b>*FIN.B</b>		<b>970,00</b>



**A735R..**

KOREK UMYWALKOWY UNIWERSALNY **CLICK CLACK**

<b>CR</b>	CHROM	<b>80,00</b>
<b>.64</b>	MIEDŹ SZCZOTKOWANA	<b>260,00</b>
<b>.DP</b>	ZŁOTY SZCZOTKOWANY	<b>320,00</b>
<b>*.FZ</b>	GUNMETAL	<b>320,00</b>
<b>*FIN.A</b>		<b>260,00</b>
<b>*FIN.B</b>		<b>320,00</b>

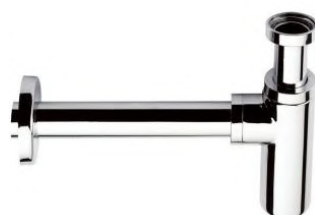

**A750..**

PÓŁSYFON UMYWALKOWY METALOWY



<b>CR</b>	CHROM	<b>320,00</b>
<b>.64</b>	MIEDŹ SZCZOTKOWANA	<b>500,00</b>
<b>.DP</b>	ZŁOTY SZCZOTKOWANY	<b>620,00</b>
<b>*.FZ</b>	GUNMETAL	<b>620,00</b>
<b>*FIN.A</b>		<b>500,00</b>
<b>*FIN.B</b>		<b>620,00</b>



**SSTXT610..** BATERIA WANNOWA ŚCIENNA TERMOSTAT

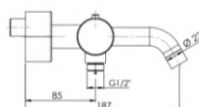

*INOX		<b>5000,00</b>
*SS1	PVD - GUNMETAL	<b>7900,00</b>
*SS2	PVD - ŻŁOTO SZCZOTK.	<b>7900,00</b>
*SS3	PVD - MIEDŹ SZCZOTK.	<b>7900,00</b>



**SSTX604B..** BATERIA BIDETOWA STOJĄCA (BEZ KORKA)

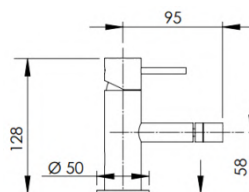

*INOX		<b>1110,00</b>
*SS1	PVD - GUNMETAL	<b>1750,00</b>
*SS2	PVD - ŻŁOTO SZCZOTK.	<b>1750,00</b>
*SS3	PVD - MIEDŹ SZCZOTK.	<b>1750,00</b>



**SSTX606..** BATERIA UMYWALKOWA STOJĄCA (BEZ KORKA)

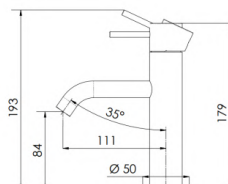

*INOX		<b>1110,00</b>
*SS1	PVD - GUNMETAL	<b>1750,00</b>
*SS2	PVD - ŻŁOTO SZCZOTK.	<b>1750,00</b>
*SS3	PVD - MIEDŹ SZCZOTK.	<b>1750,00</b>



**SSTX632P..** BATERIA UMYWALKOWA PODTYNKOWA

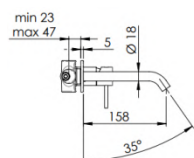

*INOX		<b>1350,00</b>
*SS1	PVD - GUNMETAL	<b>2100,00</b>
*SS2	PVD - ŻŁOTO SZCZOTK.	<b>2100,00</b>
*SS3	PVD - MIEDŹ SZCZOTK.	<b>2100,00</b>

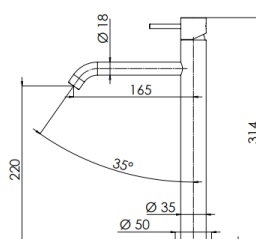

**SSTX607BN..** BATERIA UMYWALKOWA STOJĄCA (BEZ KORKA)

<b>*INOX</b>		<b>1600,00</b>
<b>*SS1</b>	PVD - GUNMETAL	<b>2500,00</b>
<b>*SS2</b>	PVD - ŻŁOTO SZCZOTK.	<b>2500,00</b>
<b>*SS3</b>	PVD - MIEDŹ SZCZOTK.	<b>2500,00</b>

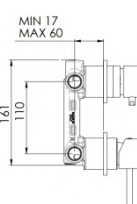

**SSTX612D2..** BATERIA PODTYNKOWA 2-DROŻNA  
**SSTX612D3..** BATERIA PODTYNKOWA 3-DROŻNA

<b>*INOX</b>		<b>2050,00</b>
<b>*SS1</b>	PVD - GUNMETAL	<b>2700,00</b>
<b>*SS2</b>	PVD - ŻŁOTO SZCZOTK.	<b>2700,00</b>
<b>*SS3</b>	PVD - MIEDŹ SZCZOTK.	<b>2700,00</b>

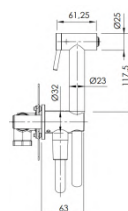

**SSTX642P..** BATERIA BIDETOWA PODTYNKOWA

<b>*INOX</b>		<b>2850,00</b>
<b>*SS1</b>	PVD - GUNMETAL	<b>4700,00</b>
<b>*SS2</b>	PVD - ŻŁOTO SZCZOTK.	<b>4700,00</b>
<b>*SS3</b>	PVD - MIEDŹ SZCZOTK.	<b>4700,00</b>

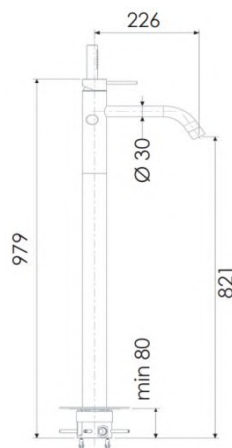

**SSTX678..** BATERIA WANNOWA WOLNOSTOJĄCA (KOMPLETNA)

<b>*INOX</b>		<b>6400,00</b>
<b>*SS1</b>	PVD - GUNMETAL	<b>10800,00</b>
<b>*SS2</b>	PVD - ŻŁOTO SZCZOTK.	<b>10800,00</b>
<b>*SS3</b>	PVD - MIEDŹ SZCZOTK.	<b>10800,00</b>

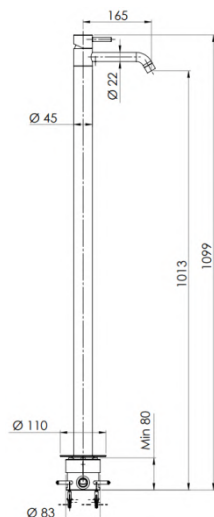

**SSTX688..** BATERIA UMYWALKOWA WOLNOSTOJĄCA (KOMPLETNA)

<b>*INOX</b>		<b>4000,00</b>
<b>*SS1</b>	PVD - GUNMETAL	<b>6500,00</b>
<b>*SS2</b>	PVD - ZŁOTO SZCZOTK.	<b>6500,00</b>
<b>*SS3</b>	PVD - MIEDŹ SZCZOTK.	<b>6500,00</b>

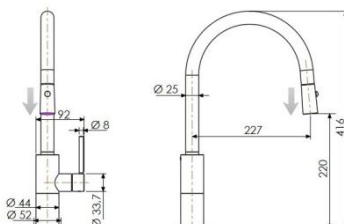

**SSTX684DJ..** BATERIA ZLEWOZMYWAKOWA STOJĄCA



<b>*INOX</b>		<b>2995,00</b>
<b>*SS1</b>	PVD - GUNMETAL	<b>4400,00</b>
<b>*SS2</b>	PVD - ZŁOTO SZCZOTK.	<b>4400,00</b>
<b>*SS3</b>	PVD - MIEDŹ SZCZOTK.	<b>4400,00</b>

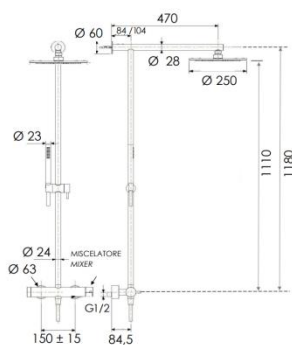

**SSTX6367825..** KOLUMNA NATRYSKOWA TK STEEL

<b>*INOX</b>		<b>5400,00</b>
<b>*SS1</b>	PVD - GUNMETAL	<b>9500,00</b>
<b>*SS2</b>	PVD - ZŁOTO SZCZOTK.	<b>9500,00</b>
<b>*SS3</b>	PVD - MIEDŹ SZCZOTK.	<b>9500,00</b>



**SSTX612D2ZWW..**

ZESTAW WANNOWY PODTYNKOWY L-165MM

<b>*INOX</b>		<b>3800,00</b>
<b>*SS1</b>	PVD - GUNMETAL	<b>4990,00</b>
<b>*SS2</b>	PVD - ŻŁOTO SZCZOTK.	<b>4990,00</b>
<b>*SS3</b>	PVD - MIEDŹ SZCZOTK.	<b>4990,00</b>



**\*SSTX615ZD2P78-25..**

ZESTAW NATRYSKOWY PODTYNKOWY SSTX I

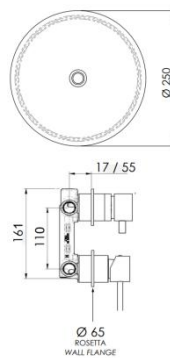

<b>*INOX</b>		<b>4800,00</b>
<b>*SS1</b>	PVD - GUNMETAL	<b>5700,00</b>
<b>*SS2</b>	PVD - ŻŁOTO SZCZOTK.	<b>5700,00</b>
<b>*SS3</b>	PVD - MIEDŹ SZCZOTK.	<b>5700,00</b>



**SSA735R..**

KOREK CLICK CLACK UNIWERSALNY

<b>*INOX</b>		<b>120,00</b>
<b>*SS1</b>	PVD - GUNMETAL	<b>260,00</b>
<b>*SS2</b>	PVD - ŻŁOTO SZCZOTK.	<b>260,00</b>
<b>*SS3</b>	PVD - MIEDŹ SZCZOTK.	<b>260,00</b>



**SSA750..**

PÓŁSYFON UMYWALKOWY 1 ¼"

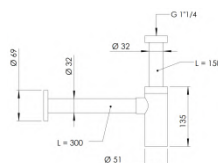

<b>*INOX</b>		<b>790,00</b>
<b>*SS1</b>	PVD - GUNMETAL	<b>1230,00</b>
<b>*SS2</b>	PVD - ŻŁOTO SZCZOTK.	<b>1230,00</b>
<b>*SS3</b>	PVD - MIEDŹ SZCZOTK.	<b>1230,00</b>



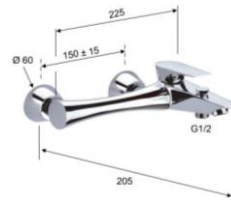

**INDEKS DV600H**

<b>CR</b>	CHROM	<b>1500,00</b>
<b>*FIN.A</b>		<b>2400,00</b>
<b>*FIN.B</b>		<b>3000,00</b>

**DV600H..** BATERIA WANNOWA ŚCIENNA (KORPUS)  
**DV610..** BATERIA WANNOWA ŚCIENNA (KOMPLETNA)

**INDEKS DV610**

<b>CR</b>	CHROM	<b>1800,00</b>
<b>*FIN.A</b>		<b>2810,00</b>
<b>*FIN.B</b>		<b>3500,00</b>



**DV604B..** BATERIA BIDETOWA STOJĄCA (BEZ KORKA)

<b>CR</b>	CHROM	<b>900,00</b>
<b>*FIN.A</b>		<b>1450,00</b>
<b>*FIN.B</b>		<b>1650,00</b>



**DV606..** BATERIA UMYWALKOWA STOJĄCA (BEZ KORKA)

<b>CR</b>	CHROM	<b>900,00</b>
<b>*FIN.A</b>		<b>1450,00</b>
<b>*FIN.B</b>		<b>1650,00</b>



**DV607..** BATERIA UMYWALKOWA WYSOKA (KOREK CLICK CLACK)

**CR** CHROM 1500,00  
**\*FIN.A** 2400,00  
**\*FIN.B** 2950,00

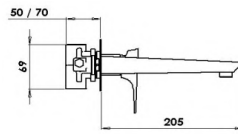

**DV632..** BATERIA UMYWALKOWA PODTYNKOWA

**CR** CHROM 1500,00  
**\*FIN.A** 2400,00  
**\*FIN.B** 3000,00

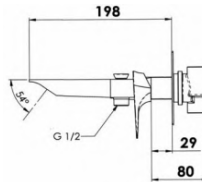

**DV652..** BATERIA WANNOWA PODTYNKOWA

  CHROM  
**CR** 2010,00  
**\*FIN.A** 3220,00  
**\*FIN.B** 4100,00

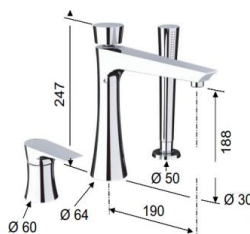

**DV691..** BATERIA WANNOWA 3-OTWOROWA

**CR** CHROM 3100,00  
**\*FIN.A** 5100,00  
**\*FIN.B** 6200,00

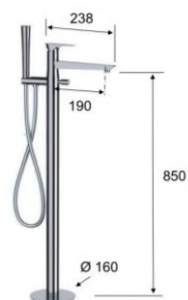

CR CHROM  
\*FIN.A  
\*FIN.B

DV678.. BATERIA WANNOWA WOLNOSTOJĄCA (KOMPLETNA)

5600,00  
8900,00  
11100,00

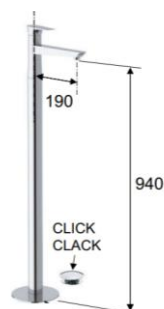
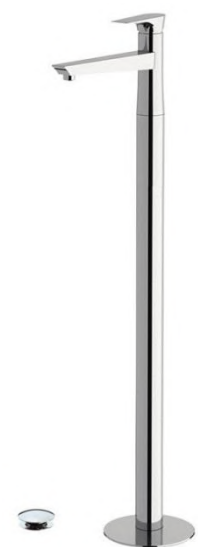

CR CHROM  
\*FIN.A  
\*FIN.B

DV688.. BATERIA UMYWALKOWA WOLNOSTOJĄCA (KOMPLETNA)

4600,00  
7400,00  
9200,00

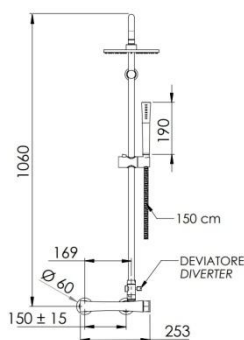

CR CHROM  
\*FIN.A  
\*FIN.B

DV636X.. KOLUMNA NATRYSKOWA

3000,00  
4800,00  
6000,00

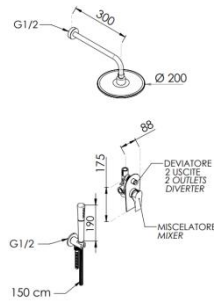

**CR** CHROM  
**\*FIN.A**  
**\*FIN.B**

**DV615ZOL..** ZESTAW NATRYSKOWY PODTYNKOWY

**2250,00**  
**3550,00**  
**4500,00**



**CR** CHROM  
**\*FIN.A**  
**\*FIN.B**

**DV4441..** ZESTAW NATRYSKOWY PODTYNKOWY

**5950,00**  
**9520,00**  
**11900,00**



**A735R..** KOREK UMYWALKOWY UNIWERSALNY **CLICK CLACK**

**CR** CHROM  
**\*FIN.A**  
**\*FIN.B**

**80,00**  
**260,00**  
**320,00**

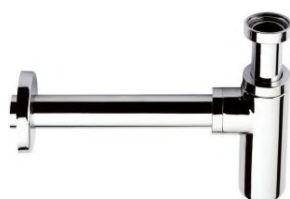

**A750..** PÓŁSYFON UMYWALKOWY METALOWY

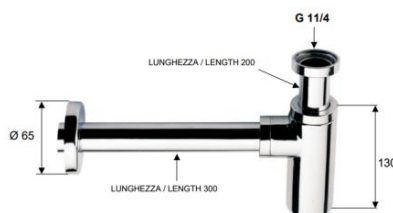

**CR** CHROM  
**\*FIN.A**  
**\*FIN.B**

**320,00**  
**500,00**  
**600,00**

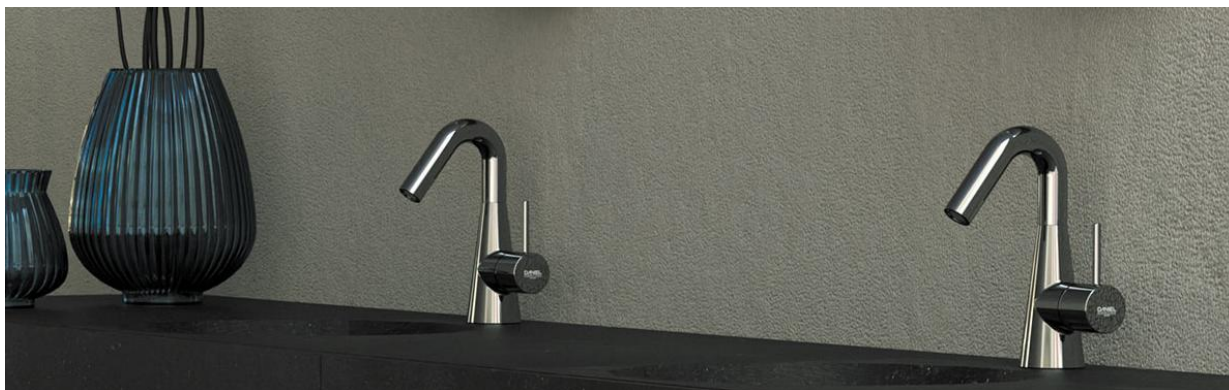

**SG604B..** BATERIA BIDETOWA STOJĄCA (BEZ KORKA)

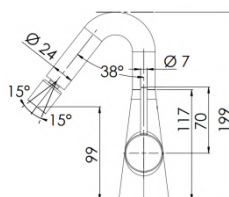

<b>*CR</b>	CHROM	<b>700,00</b>
<b>*.64</b>	MIEDŹ SZCZOTKOWANA	<b>1100,00</b>
<b>*.DP</b>	ZŁOTO SZCZOTKOWANE	<b>1400,00</b>
<b>*.FZ</b>	GUNMETAL	<b>1400,00</b>
<b>*FIN.A</b>		<b>1100,00</b>
<b>*FIN.B</b>		<b>1400,00</b>



**SG606..** BATERIA UMYWALKOWA STOJĄCA (BEZ KORKA)

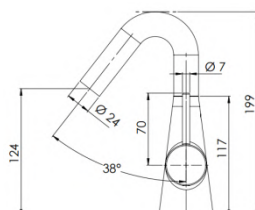

<b>*CR</b>	CHROM	<b>700,00</b>
<b>*.64</b>	MIEDŹ SZCZOTKOWANA	<b>1100,00</b>
<b>*.DP</b>	ZŁOTO SZCZOTKOWANE	<b>1400,00</b>
<b>.FZ</b>	GUNMETAL	<b>1400,00</b>
<b>*FIN.A</b>		<b>1100,00</b>
<b>*FIN.B</b>		<b>1400,00</b>



**SG655..** BATERIA UMYWALKOWA 2-OTWOROWA

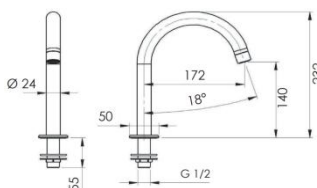

<b>*CR</b>	CHROM	<b>790,00</b>
<b>*.64</b>	MIEDŹ SZCZOTKOWANA	<b>1220,00</b>
<b>*.DP</b>	ZŁOTO SZCZOTKOWANE	<b>1500,00</b>
<b>*.FZ</b>	GUNMETAL	<b>1500,00</b>
<b>*FIN.A</b>		<b>1220,00</b>
<b>*FIN.B</b>		<b>1500,00</b>



**SG632P..** BATERIA UMYWALKOWA PODTYNKOWA (ZINTEGROWANA)

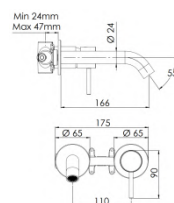

<b>*CR</b>	CHROM	<b>1220,00</b>
<b>*.64</b>	MIEDŹ SZCZOTKOWANA	<b>1950,00</b>
<b>*.DP</b>	ZŁOTO SZCZOTKOWANE	<b>2440,00</b>
<b>*.FZ</b>	GUNMETAL	<b>2440,00</b>
<b>*FIN.A</b>		<b>1950,00</b>
<b>*FIN.B</b>		<b>2440,00</b>



**SG6454DC..** BATERIA BIDETOWA PODTYNKOWA

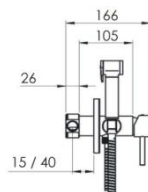

<b>*CR</b>	CHROM	<b>850,00</b>
<b>*.64</b>	MIEDŹ SZCZOTKOWANA	<b>1300,00</b>
<b>*.DP</b>	ZŁOTO SZCZOTKOWANE	<b>1500,00</b>
<b>*.FZ</b>	GUNMETAL	<b>1500,00</b>
<b>*FIN.A</b>		<b>1300,00</b>
<b>*FIN.B</b>		<b>1500,00</b>

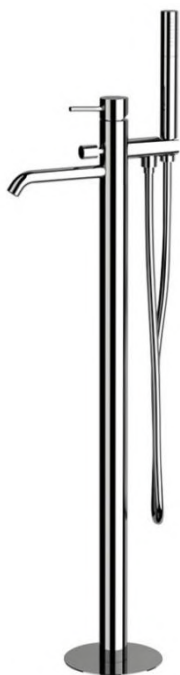

**SG678..** BATERIA WANNOWA WOLNOSTOJĄCA (KOMPLETNA)

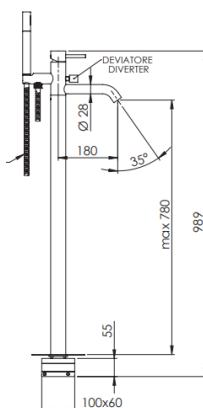

<b>*CR</b>	CHROM	<b>4950,00</b>
<b>*.64</b>	MIEDŹ SZCZOTKOWANA	<b>7900,00</b>
<b>*.DP</b>	ZŁOTO SZCZOTKOWANE	<b>9850,00</b>
<b>*.FZ</b>	GUNMETAL	<b>9850,00</b>
<b>*FIN.A</b>		<b>7900,00</b>
<b>*FIN.B</b>		<b>9850,00</b>

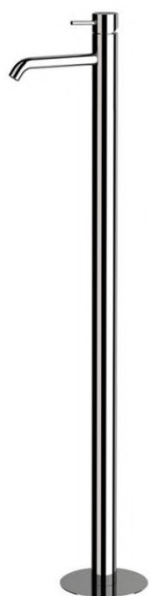

**SG688..** BATERIA UMYWALKOWA WOLNOSTOJĄCA (KOMPLETNA)

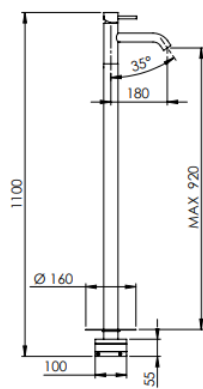

<b>*CR</b>	CHROM	<b>4300,00</b>
<b>*.64</b>	MIEDŹ SZCZOTKOWANA	<b>6800,00</b>
<b>*.DP</b>	ZŁOTO SZCZOTKOWANE	<b>8500,00</b>
<b>*.FZ</b>	GUNMETAL	<b>8500,00</b>
<b>*FIN.A</b>		<b>6800,00</b>
<b>*FIN.B</b>		<b>8500,00</b>

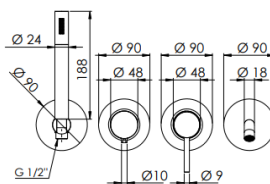

*CR	CHROM	2300,00
*.64	MIEDŹ SZCZOTKOWANA	3600,00
*.DP	ZŁOTO SZCZOTKOWANE	4500,00
*.FZ	GUNMETAL	4500,00
*FIN.A		3600,00
*FIN.B		4500,00

**SG625ZWW..** ZESTAW WANNOWY PODTYNKOWY L-165MM

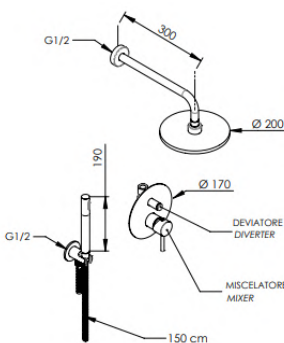

*CR	CHROM	1600,00
*.64	MIEDŹ SZCZOTKOWANA	2500,00
*.DP	ZŁOTO SZCZOTKOWANE	3100,00
*.FZ	GUNMETAL	3100,00
*FIN.A		2500,00
*FIN.B		3100,00

**SG615Z0..** ZESTAW NATRYSKOWY PODTYNKOWY



**A735R..** KOREK UMYWALKOWY UNIWERSALNY CLICK CLACK

CR	CHROM	80,00
.64	MIEDŹ SZCZOTKOWANA	260,00
.DP	ZŁOTO SZCZOTKOWANE	320,00
.FZ	GUNMETAL	320,00
*FIN.A		260,00
*FIN.B		320,00

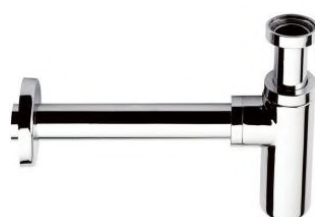

**A750..** PÓŁSYFON UMYWALKOWY METALOWY



CR	CHROM	320,00
.64	MIEDŹ SZCZOTKOWANA	500,00
.DP	ZŁOTO SZCZOTKOWANE	620,00
*.FZ	GUNMETAL	620,00
*FIN.A		500,00
*FIN.B		620,00

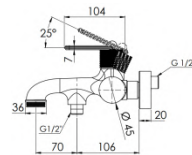

**CR** CHROM 1820,00  
**\*FIN.A** 2920,00  
**\*FIN.B** 3650,00

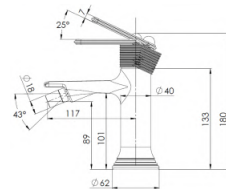

**CR** CHROM 965,00  
**\*FIN.A** 1540,00  
**\*FIN.B** 1925,00

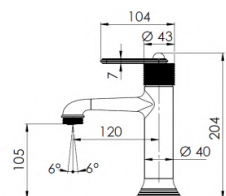

**CR** CHROM 965,00  
**\*FIN.A** 1540,00  
**\*FIN.B** 1925,00

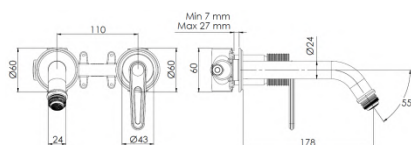

**CR** CHROM 1850,00  
**\*FIN.A** 3000,00  
**\*FIN.B** 3700,00





**BY607B..**

BATERIA UMYWALKOWA WYSOKA (BEZ KORKA)

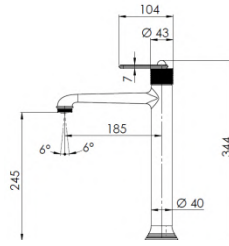

<b>CR</b>	CHROM	<b>1410,00</b>
<b>*FIN.A</b>		<b>2260,00</b>
<b>*FIN.B</b>		<b>2850,00</b>



**BY645DCZ..**

BATERIA BIDETOWA PODTYNKOWA

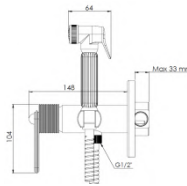

<b>*CR</b>	CHROM	<b>1200,00</b>
<b>*FIN.A</b>		<b>1850,00</b>
<b>*FIN.B</b>		<b>2320,00</b>

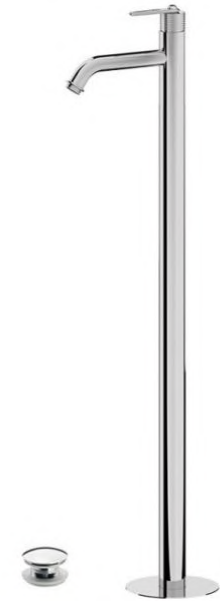

**BY688..**

BATERIA UMYWALKOWA WOLNOSTOJĄCA (KOMPLETNA)

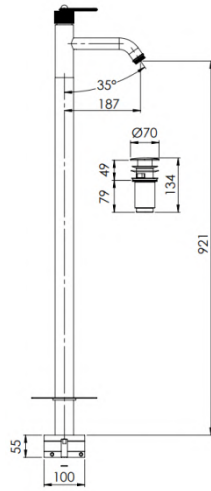

<b>CR</b>	CHROM	<b>4450,00</b>
<b>*FIN.A</b>		<b>7140,00</b>
<b>*FIN.B</b>		<b>8900,00</b>



**BY710D2P..**

BATERIA WANNOWA PODTYNKOWA L-201MM

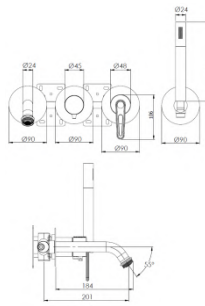

<b>CR</b>	CHROM	<b>3150,00</b>
<b>*FIN.A</b>		<b>5000,00</b>
<b>*FIN.B</b>		<b>6200,00</b>

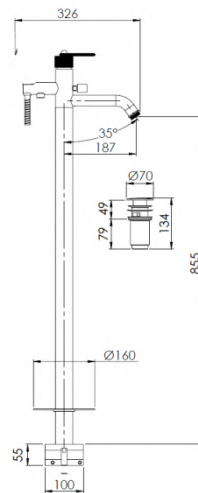

**BY678..** BATERIA WANNOWA WOLNOSTOJĄCA (KOMPLETNA)

**CR** CHROM 5100,00  
**\*FIN.A** 8200,00  
**\*FIN.B** 10000,00



**BY715ZOD2P..** ZESTAW NATRYSKOWY PODTYNKOWY

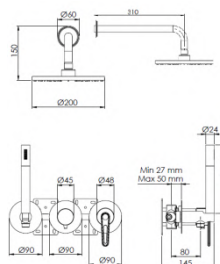

**CR** CHROM 3550,00  
**\*FIN.A** 5700,00  
**\*FIN.B** 7100,00



**A735R..** KOREK UMYWALKOWY UNIWERSALNY **CLICK CLACK**

**CR** CHROM 80,00  
**\*FIN.A** 260,00  
**\*FIN.B** 320,00

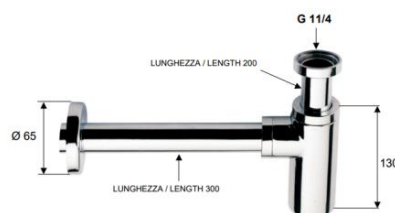

**A750..** PÓŁSYFON UMYWALKOWY METALOWY

**CR** CHROM 320,00  
**\*FIN.A** 500,00  
**\*FIN.B** 620,00



**RT4102..** BATERIA WANNOWA ŚCIENNA (KOMPLETNA)  
**RY4102..** BATERIA WANNOWA ŚCIENNA (KOMPLETNA)

SWAROVSKI



INDEKS RT – UCHWYT Z ŻYWICY

<b>CR</b>	CHROM	1200,00
<b>*FIN.A</b>		1950,00
<b>*FIN.B</b>		2400,00

INDEKS RY – UCHWYT SWAROVSKI

<b>*CR</b>	CHROM	2050,00
<b>*FIN.A</b>		3300,00
<b>*FIN.B</b>		4100,00



**RT4102XL..** BATERIA WANNOWA WOLNOSTOJĄCA (KOMPLETNA)  
**RY4102XL..** BATERIA WANNOWA WOLNOSTOJĄCA (KOMPLETNA)

SWAROVSKI



INDEKS RT – UCHWYT Z ŻYWICY

<b>CR</b>	CHROM	3000,00
<b>*FIN.A</b>		4500,00
<b>*FIN.B</b>		5500,00

INDEKS RY – UCHWYT SWAROVSKI

<b>*CR</b>	CHROM	3600,00
<b>*FIN.A</b>		5800,00
<b>*FIN.B</b>		7200,00



**RT5003..** BATERIA UMYWALKOWA 3-OTWOROWA  
**RY5003..** BATERIA UMYWALKOWA 3-OTWOROWA

SWAROVSKI



INDEKS RT – UCHWYT Z ŻYWICY

<b>CR</b>	CHROM	950,00
<b>*FIN.A</b>		1520,00
<b>*FIN.B</b>		1900,00

INDEKS RY – UCHWYT SWAROVSKI

<b>*CR</b>	CHROM	1750,00
<b>*FIN.A</b>		2800,00
<b>*FIN.B</b>		3500,00



**RT5112..** BATERIA UMYWALKOWA STOJĄCA (KOREK AUTOMATYCZNY)

<b>*CR</b>	CHROM	<b>800,00</b>
<b>*FIN.A</b>		<b>1280,00</b>
<b>*FIN.B</b>		<b>1600,00</b>



**RT5112L..** BATERIA UMYWALKOWA STOJĄCA (KOREK AUTOMATYCZNY)

**RY5112L..** BATERIA UMYWALKOWA STOJĄCA (KOREK AUTOMATYCZNY) **SWAROVSKI**

<b>INDEKS RT – UCHWYT Z ŻYWICY</b>		
<b>CR</b>	CHROM	<b>1100,00</b>
<b>*FIN.A</b>		<b>1800,00</b>
<b>*FIN.B</b>		<b>2200,00</b>

<b>INDEKS RY – UCHWYT SWAROVSKI</b>		
<b>*CR</b>	CHROM	<b>1900,00</b>
<b>*FIN.A</b>		<b>3050,00</b>
<b>*FIN.B</b>		<b>3800,00</b>



**RT6200..** BATERIA BIDETOWA STOJĄCA (KOREK AUTOMATYCZNY)

**RY6200..** BATERIA BIDETOWA STOJĄCA (KOREK AUTOMATYCZNY) **SWAROVSKI**

<b>INDEKS RT – UCHWYT Z ŻYWICY</b>		
<b>CR</b>	CHROM	<b>780,00</b>
<b>*FIN.A</b>		<b>1250,00</b>
<b>*FIN.B</b>		<b>1560,00</b>

<b>INDEKS RY – UCHWYT SWAROVSKI</b>		
<b>*CR</b>	CHROM	<b>1580,00</b>
<b>*FIN.A</b>		<b>2530,00</b>
<b>*FIN.B</b>		<b>3200,00</b>



**RT602..** BATERIA PODTYNKOWA 1-DROŻNA

**RY602..** BATERIA PODTYNKOWA 1-DROŻNA **SWAROVSKI**

<b>INDEKS RT – UCHWYT Z ŻYWICY</b>		
<b>CR</b>	CHROM	<b>360,00</b>
<b>*FIN.A</b>		<b>580,00</b>
<b>*FIN.B</b>		<b>720,00</b>

<b>INDEKS RY – UCHWYT SWAROVSKI</b>		
<b>*CR</b>	CHROM	<b>700,00</b>
<b>*FIN.A</b>		<b>1150,00</b>
<b>*FIN.B</b>		<b>1400,00</b>



**RT612..** BATERIA PODTYNKOWA 2-DROŻNA

**RY612..** BATERIA PODTYNKOWA 2-DROŻNA **SWAROVSKI**

<b>INDEKS RT – UCHWYT Z ŻYWICY</b>		
<b>CR</b>	CHROM	<b>620,00</b>
<b>*FIN.A</b>		<b>995,00</b>
<b>*FIN.B</b>		<b>1240,00</b>

<b>INDEKS RY – UCHWYT SWAROVSKI</b>		
<b>*CR</b>	CHROM	<b>960,00</b>
<b>*FIN.A</b>		<b>1550,00</b>
<b>*FIN.B</b>		<b>1920,00</b>



**RTV604..** BATERIA BIDETOWA STOJĄCA (KOREK AUTOMATYCZNY)  
**RYV604..** BATERIA BIDETOWA STOJĄCA (KOREK AUTOMATYCZNY)



SWAROVSKI

**INDEKS RT – UCHWYT Z ŻYWICY**

<b>CR</b>	CHROM	<b>700,00</b>
<b>*FIN.A</b>		<b>1120,00</b>
<b>*FIN.B</b>		<b>1400,00</b>

**INDEKS RY – UCHWYT SWAROVSKI**

<b>*CR</b>	CHROM	<b>1050,00</b>
<b>*FIN.A</b>		<b>1680,00</b>
<b>*FIN.B</b>		<b>2100,00</b>



**RTV605..** BATERIA UMYWALKOWA STOJĄCA (KOREK AUTOMATYCZNY)  
**RYV605..** BATERIA UMYWALKOWA STOJĄCA (KOREK AUTOMATYCZNY)



SWAROVSKI

**INDEKS RT – UCHWYT Z ŻYWICY**

<b>CR</b>	CHROM	<b>700,00</b>
<b>*FIN.A</b>		<b>1120,00</b>
<b>*FIN.B</b>		<b>1400,00</b>

**INDEKS RY – UCHWYT SWAROVSKI**

<b>*CR</b>	CHROM	<b>1050,00</b>
<b>*FIN.A</b>		<b>1680,00</b>
<b>*FIN.B</b>		<b>2100,00</b>



**RT645..** BATERIA BIDETOWA PODTYNKOWA **RETRO**

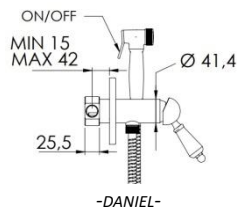

<b>*CR</b>	CHROM	<b>1150,00</b>
<b>*FIN.A</b>		<b>1840,00</b>
<b>*FIN.B</b>		<b>2300,00</b>



**RT015ZSCF..** ZESTAW NATRYSKOWY PODTYNKOWY  
**RY015ZSCF..** ZESTAW NATRYSKOWY PODTYNKOWY

SKŁAD ZESTAWU:  
- DESZCZOWNICA:  
(INDEKS F) C00655    Ø205MM –EMMEVI-  
- RAMIĘ ŚCIENNE C00684    L-325MM –EMMEVI-  
- ZESTAW 3W1 157 –EMMEVI-

SWAROVSKI



**INDEKS RT – UCHWYT Z ŻYWICY**

<b>CR</b>	CHROM	<b>2070,00</b>
<b>*FIN.A</b>		<b>3400,00</b>
<b>*FIN.B</b>		<b>5000,00</b>

**INDEKS RY – UCHWYT SWAROVSKI**

<b>*CR</b>	CHROM	<b>2500,00</b>
<b>*FIN.A</b>		<b>4000,00</b>
<b>*FIN.B</b>		<b>5500,00</b>

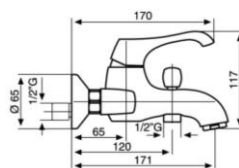
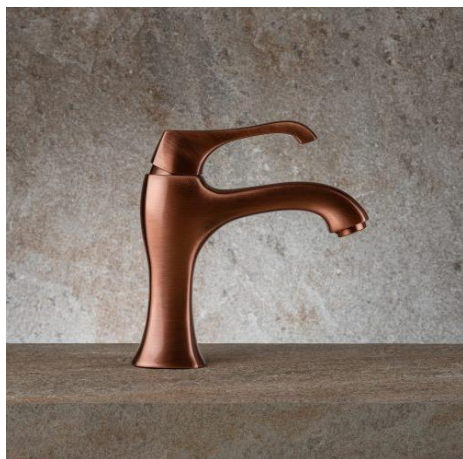

**76001..** BATERIA WANNOWA ŚCIENNA (KORPUS)

<b>CR</b>	CHROM	<b>700,00</b>
<b>*BIO</b>	BIAŁY MAT	<b>860,00</b>
<b>*NO</b>	CZARNY MAT	<b>860,00</b>
<b>*NS</b>	STAL SZCZOTKOWANA	<b>990,00</b>
<b>*RA</b>	MIEDŹ SZCZOTKOWANA	<b>990,00</b>
<b>*BR</b>	STARE ŻŁOTO	<b>990,00</b>
<b>*ORSP</b>	ŻŁOTO SZCZOTKOWANY	<b>1650,00</b>

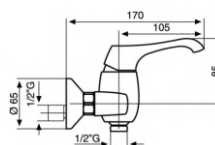

**76002..** BATERIA NATRYSKOWA ŚCIENNA (KORPUS)

<b>CR</b>	CHROM	<b>470,00</b>
<b>*BIO</b>	BIAŁY MAT	<b>620,00</b>
<b>*NO</b>	CZARNY MAT	<b>620,00</b>
<b>*NS</b>	STAL SZCZOTKOWANA	<b>680,00</b>
<b>*RA</b>	MIEDŹ SZCZOTKOWANA	<b>680,00</b>
<b>*BR</b>	STARE ŻŁOTO	<b>680,00</b>
<b>*ORSP</b>	ŻŁOTO SZCZOTKOWANY	<b>1200,00</b>

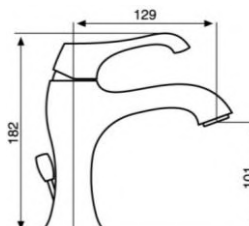

**76003..** BATERIA UMYWALKOWA STOJĄCA (KOREK AUTOMATYCZNY)

<b>CR</b>	CHROM	<b>690,00</b>
<b>*BIO</b>	BIAŁY MAT	<b>860,00</b>
<b>*NO</b>	CZARNY MAT	<b>860,00</b>
<b>*NS</b>	STAL SZCZOTKOWANA	<b>995,00</b>
<b>*RA</b>	MIEDŹ SZCZOTKOWANA	<b>995,00</b>
<b>*BR</b>	STARE ŻŁOTO	<b>995,00</b>
<b>*ORSP</b>	ŻŁOTO SZCZOTKOWANY	<b>1630,00</b>

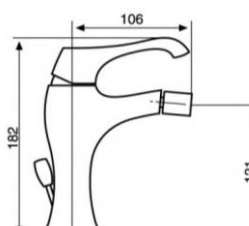

**76004..** BATERIA BIDETOWA STOJĄCA (KOREK AUTOMATYCZNY)

<b>CR</b>	CHROM	<b>690,00</b>
<b>*BIO</b>	BIAŁY MAT	<b>860,00</b>
<b>*NO</b>	CZARNY MAT	<b>860,00</b>
<b>*NS</b>	STAL SZCZOTKOWANA	<b>995,00</b>
<b>*RA</b>	MIEDŹ SZCZOTKOWANA	<b>995,00</b>
<b>*BR</b>	STARE ŻŁOTO	<b>995,00</b>
<b>*ORSP</b>	ŻŁOTO SZCZOTKOWANY	<b>1630,00</b>

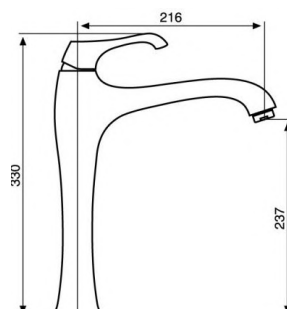

**76006..** BATERIA UMYWALKOWA WYSOKA (KOREK CLICK CLACK)

<b>CR</b>	CHROM	<b>1580,00</b>
<b>*BIO</b>	BIAŁY MAT	<b>1950,00</b>
<b>*NO</b>	CZARNY MAT	<b>1950,00</b>
<b>*NS</b>	STAL SZCZOTKOWANA	<b>2200,00</b>
<b>*RA</b>	MIEDŹ SZCZOTKOWANA	<b>2200,00</b>
<b>*BR</b>	STARE ŻŁOTO	<b>2200,00</b>
<b>*ORSP</b>	ŻŁOTY SZCZOTKOWANY	<b>3450,00</b>

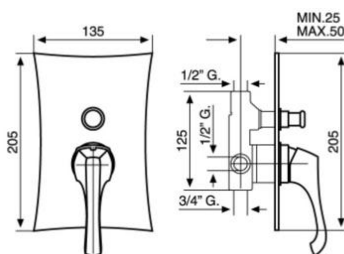

**76019..** BATERIA PODTYNKOWA 2-DROŻNA

<b>CR</b>	CHROM	<b>980,00</b>
<b>*BIO</b>	BIAŁY MAT	<b>1350,00</b>
<b>*NO</b>	CZARNY MAT	<b>1350,00</b>
<b>*NS</b>	STAL SZCZOTKOWANA	<b>1390,00</b>
<b>*RA</b>	MIEDŹ SZCZOTKOWANA	<b>1390,00</b>
<b>*BR</b>	STARE ŻŁOTO	<b>1390,00</b>
<b>*ORSP</b>	ŻŁOTY SZCZOTKOWANY	<b>2250,00</b>

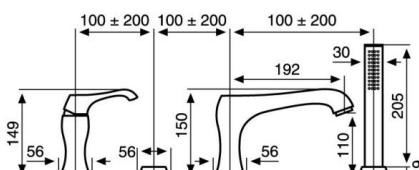

**76120..** BATERIA WANNOWA 4-OTWOROWA

<b>CR</b>	CHROM	<b>2200,00</b>
<b>*BIO</b>	BIAŁY MAT	<b>2780,00</b>
<b>*NO</b>	CZARNY MAT	<b>2780,00</b>
<b>*NS</b>	STAL SZCZOTKOWANA	<b>3060,00</b>
<b>*RA</b>	MIEDŹ SZCZOTKOWANA	<b>3060,00</b>
<b>*BR</b>	STARE ŻŁOTO	<b>3060,00</b>
<b>*ORSP</b>	ŻŁOTY SZCZOTKOWANY	<b>5100,00</b>



**SKŁAD ZESTAWU:**  
 - ZESTAW 3W1  
 - WYLEWKA ŚCIENNA L-18,0cm



**AR015ZWW..** ZESTAW WANNOWY PODTYNKOWY

<b>CR</b>	CHROM	<b>1700,00</b>
<b>*BIO</b>	BIAŁY MAT	<b>2400,00</b>
<b>*NO</b>	CZARNY MAT	<b>2400,00</b>
<b>*NS</b>	STAL SZCZOTKOWANA	<b>2600,00</b>
<b>*RA</b>	MIEDŹ SZCZOTKOWANA	<b>2600,00</b>
<b>*BR</b>	STARE ŻŁOTO	<b>2600,00</b>
<b>*ORSP</b>	ŻŁOTY SZCZOTKOWANY	<b>3220,00</b>



**SKŁAD ZESTAWU:**  
 - DESZCZOWNICA:  
 (INDEKS A) ZSOF074  $\varnothing 22,5\text{cm}$  - PAFFONI-  
 (INDEKS E) C06657  $\varnothing 30\text{cm}$   
 - RAMIĘ ŚCIENNE L-400MM  
 - ZESTAW 3W1



**INDEKS A** ZSOF074  $\varnothing 225\text{mm}$

<b>CR</b>	CHROM	<b>1985,00</b>
<b>*NO</b>	CZARNY MAT	<b>2860,00</b>

**INDEKS E** C06657-30  $\varnothing 250\text{mm}$

<b>CR</b>	CHROM	<b>3000,00</b>
<b>*BIO</b>	BIAŁY MAT	<b>4200,00</b>
<b>*NO</b>	CZARNY MAT	<b>4200,00</b>
<b>*NS</b>	STAL SZCZOTKOWANA	<b>4450,00</b>
<b>*RA</b>	MIEDŹ SZCZOTKOWANA	<b>4450,00</b>
<b>*BR</b>	STARE ŻŁOTO	<b>4450,00</b>
<b>*ORSP</b>	ŻŁOTY SZCZOTKOWANY	<b>6000,00</b>

**AR015ZSC3..** ZESTAW NATRYSKOWY PODTYNKOWY (RAMIĘ 400MM)

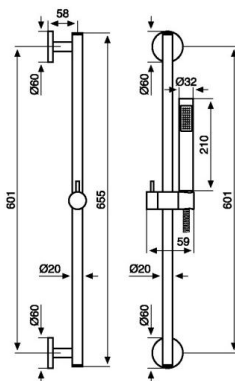

<b>CR</b>	CHROM	<b>690,00</b>
<b>BIO</b>	BIAŁY MAT	<b>1000,00</b>
<b>NO</b>	CZARNY MAT	<b>1000,00</b>
<b>NS</b>	STAL SZCZOTKOWANA	<b>1300,00</b>
<b>*RA</b>	MIEDŹ SZCZOTKOWANA	<b>1300,00</b>
<b>BR</b>	STARE ŻŁOTO	<b>1300,00</b>
<b>ORSP</b>	ŻŁOTY SZCZOTKOWANY	<b>2000,00</b>

**C02669..** ZESTAW NATRYSKOWY **LIFE**

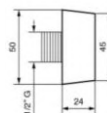

**C02283..** PRZYŁĄCZE KĄTOWE METALOWE

<b>CR</b>	CHROM	<b>75,00</b>
<b>BIO</b>	BIAŁY MAT	<b>180,00</b>
<b>NO</b>	CZARNY MAT	<b>180,00</b>
<b>NS</b>	STAL SZCZOTKOWANA	<b>290,00</b>
<b>*RA</b>	MIEDŹ SZCZOTKOWANA	<b>290,00</b>
<b>BR</b>	STARE ŻŁOTO	<b>290,00</b>
<b>ORSP</b>	ŻŁOTY SZCZOTKOWANY	<b>380,00</b>

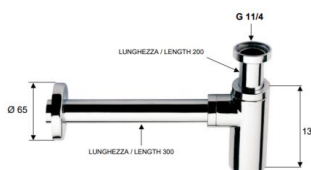

**C06633..** PÓŁSYFON UMYWALKOWY METALOWY 1 1/4"

<b>CR</b>	CHROM	<b>360,00</b>
<b>BIO</b>	BIAŁY MAT	<b>720,00</b>
<b>NO</b>	CZARNY MAT	<b>720,00</b>
<b>NS</b>	STAL SZCZOTKOWANA	<b>750,00</b>
<b>*RA</b>	MIEDŹ SZCZOTKOWANA	<b>750,00</b>
<b>BR</b>	STARE ŻŁOTO	<b>750,00</b>
<b>ORSP</b>	ŻŁOTY SZCZOTKOWANY	<b>980,00</b>





UCHWYT STANDARDOWY - ŻYWICA

UCHWYT Z KRYSZTAŁAMI SWAROVSKI CZARNE



**40011..** BATERIA WANNOWA ŚCIENNA (KOMPLETNA)

**40011KOL..** BATERIA WANNOWA WOLNOSTOJĄCA (KOLANA C02850 \*EMMEVI\*)

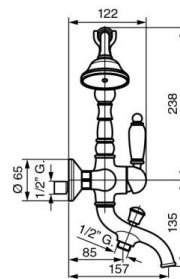

INDEKS 40011

<b>CR</b>	CHROM	1400,00
<b>*CRSWNE</b>	CHROM+SWAROVSKI	1650,00
<b>BR</b>	STARE ŻŁOTO	2000,00
<b>*RA</b>	MIEDŹ SZCZOTKOWANA	2000,00
<b>*OR</b>	ŻŁOTY BŁYSZCZĄCY	3100,00

INDEKS 40011KOL

<b>CR</b>	CHROM	4400,00
<b>*CRSWNE</b>	CHROM+SWAROVSKI	4650,00
<b>BR</b>	STARE ŻŁOTO	7460,00
<b>*RA</b>	MIEDŹ SZCZOTKOWANA	7460,00
<b>*OR</b>	ŻŁOTY BŁYSZCZĄCY	11500,00



**40061..** BATERIA WANNOWA ŚCIENNA (KORPUS)

**40061B..** BATERIA WANNOWA ŚCIENNA (KOMPLETNA)

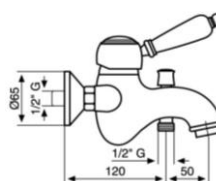

INDEKS 40061

<b>CR</b>	CHROM	980,00
<b>*CRSWNE</b>	CHROM+SWAROVSKI	1230,00
<b>BR</b>	STARE ŻŁOTO	1410,00
<b>*RA</b>	MIEDŹ SZCZOTKOWANA	1410,00
<b>*OR</b>	ŻŁOTY BŁYSZCZĄCY	2150,00

INDEKS 40061B

<b>CR</b>	CHROM	1200,00
<b>*CRSWNE</b>	CHROM+SWAROVSKI	1450,00
<b>BR</b>	STARE ŻŁOTO	1700,00
<b>*RA</b>	MIEDŹ SZCZOTKOWANA	1700,00
<b>*OR</b>	ŻŁOTY BŁYSZCZĄCY	2600,00



**40062..** BATERIA NATRYSKOWA ŚCIENNA (KORPUS)

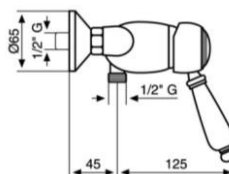

<b>CR</b>	CHROM	705,00
<b>*CRSWNE</b>	CHROM+SWAROVSKI	955,00
<b>BR</b>	STARE ŻŁOTO	1110,00
<b>*RA</b>	MIEDŹ SZCZOTKOWANA	1110,00
<b>*OR</b>	ŻŁOTY BŁYSZCZĄCY	1600,00

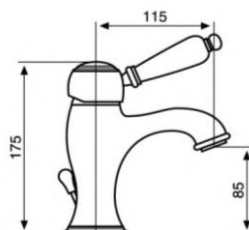

**40063..** BATERIA UMYWALKOWA STOJĄCA (KOREK AUTOMATYCZNY)

<b>CR</b>	CHROM	<b>820,00</b>
<b>*CRSWNE</b>	CHROM+SWAROVSKI	<b>1120,00</b>
<b>BR</b>	STARE ZŁOTO	<b>1260,00</b>
<b>*RA</b>	MIEDŹ SZCZOTKOWANA	<b>1260,00</b>
<b>*OR</b>	ZŁOTY BŁYSZCZĄCY	<b>1950,00</b>

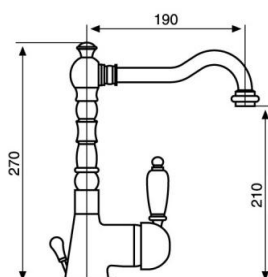

**40513..** BATERIA UMYWALKOWA STOJĄCA (KOREK AUTOMATYCZNY)



<b>CR</b>	CHROM	<b>960,00</b>
<b>*CRSWNE</b>	CHROM+SWAROVSKI	<b>1210,00</b>
<b>BR</b>	STARE ZŁOTO	<b>1420,00</b>
<b>*RA</b>	MIEDŹ SZCZOTKOWANA	<b>1420,00</b>
<b>*OR</b>	ZŁOTY BŁYSZCZĄCY	<b>2130,00</b>

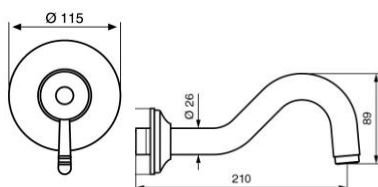

**4009-1029..** BATERIA UMYWALKOWA PODTYNKOWA L-210MM

<b>CR</b>	CHROM	<b>705,00</b>
<b>*CRSWNE</b>	CHROM+SWAROVSKI	<b>955,00</b>
<b>BR</b>	STARE ZŁOTO	<b>1000,00</b>
<b>*RA</b>	MIEDŹ SZCZOTKOWANA	<b>1000,00</b>
<b>*OR</b>	ZŁOTY BŁYSZCZĄCY	<b>1480,00</b>

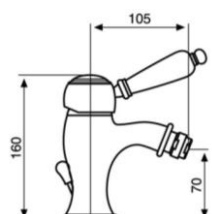

**40064..** BATERIA BIDETOWA STOJĄCA (KOREK AUTOMATYCZNY)

<b>CR</b>	CHROM	<b>820,00</b>
<b>*CRSWNE</b>	CHROM+SWAROVSKI	<b>1120,00</b>
<b>BR</b>	STARE ZŁOTO	<b>1260,00</b>
<b>*RA</b>	MIEDŹ SZCZOTKOWANA	<b>1260,00</b>
<b>*OR</b>	ZŁOTY BŁYSZCZĄCY	<b>1950,00</b>

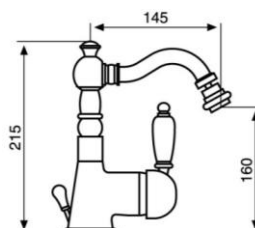

**40514..** BATERIA BIDETOWA STOJĄCA (KOREK AUTOMATYCZNY)

<b>CR</b>	CHROM	<b>960,00</b>
<b>*CRSWNE</b>	CHROM+SWAROVSKI	<b>1210,00</b>
<b>BR</b>	STARE ZŁOTO	<b>1420,00</b>
<b>*RA</b>	MIEDŹ SZCZOTKOWANA	<b>1420,00</b>
<b>*OR</b>	ZŁOTY BŁYSZCZĄCY	<b>2130,00</b>

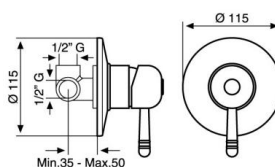

**40009..** BATERIA PODTYNKOWA 1-DROŻNA

<b>CR</b>	CHROM	<b>405,00</b>
<b>*CRSWNE</b>	CHROM+SWAROVSKI	<b>655,00</b>
<b>BR</b>	STARE ZŁOTO	<b>650,00</b>
<b>*RA</b>	MIEDŹ SZCZOTKOWANA	<b>650,00</b>
<b>*OR</b>	ZŁOTY BŁYSZCZĄCY	<b>980,00</b>

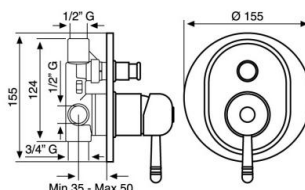

**40019..** BATERIA PODTYNKOWA 2-DROŻNA

<b>CR</b>	CHROM	<b>750,00</b>
<b>*CRSWNE</b>	CHROM+SWAROVSKI	<b>1000,00</b>
<b>BR</b>	STARE ZŁOTO	<b>1080,00</b>
<b>*RA</b>	MIEDŹ SZCZOTKOWANA	<b>1080,00</b>
<b>*OR</b>	ZŁOTY BŁYSZCZĄCY	<b>1620,00</b>

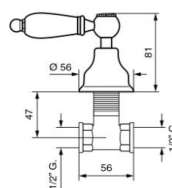

**121009..** ZAWÓR PODTYNKOWY (1 ODBORNIK) – KOMPLET 2 SZTUKI  
**121019..** ZAWÓR PODTYNKOWY (2 ODBORNIKI)  
**121029..** ZAWÓR PODTYNKOWY (3 ODBORNIKI)

<b>INDEKS 121009</b>		
<b>CR</b>	CHROM	<b>725,00</b>
<b>BR</b>	STARE ZŁOTO	<b>1110,00</b>
<b>*RA</b>	MIEDŹ SZCZOTKOWANA	<b>1110,00</b>
<b>*OR</b>	ZŁOTY BŁYSZCZĄCY	<b>1700,00</b>

<b>INDEKS 121019 LUB 121029</b>		
<b>CR</b>	CHROM	<b>555,00</b>
<b>BR</b>	STARE ZŁOTO	<b>800,00</b>
<b>*RA</b>	MIEDŹ SZCZOTKOWANA	<b>800,00</b>
<b>*OR</b>	ZŁOTY BŁYSZCZĄCY	<b>1220,00</b>

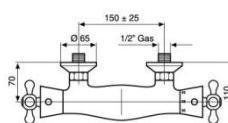

**12300..** BATERIA NATRYSKOWA ŚCIENNATERMOSTATYCZNA (KORPUS)

<b>CR</b>	CHROM	<b>1200,00</b>
<b>BR</b>	STARE ZŁOTO	<b>1800,00</b>
<b>*RA</b>	MIEDŹ SZCZOTKOWANA	<b>1800,00</b>
<b>*OR</b>	ZŁOTY BŁYSZCZĄCY	<b>2760,00</b>

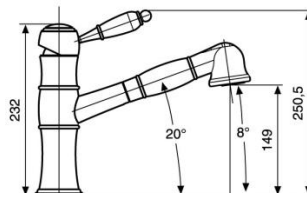

<b>CR</b>	CHROM	<b>1500,00</b>
<b>*CRSWNE</b>	CHROM+SWAROVSKI	<b>1900,00</b>
<b>BR</b>	STARE ZŁOTO	<b>2310,00</b>
<b>*RA</b>	MIEDŹ SZCZOTKOWANA	<b>2310,00</b>
<b>*OR</b>	ZŁOTY BŁYSZCZĄCY	<b>3550,00</b>

**40065..** BATERIA ZLEWOZMYWAKOWA STOJĄCA Z WĘŻEM OPERACYJNYM

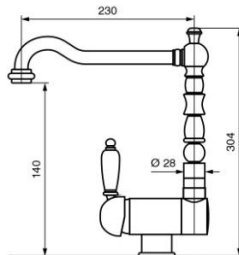

<b>CR</b>	CHROM	<b>1100,00</b>
<b>*CRSWNE</b>	CHROM+SWAROVSKI	<b>1450,00</b>
<b>BR</b>	STARE ZŁOTO	<b>1750,00</b>
<b>*RA</b>	MIEDŹ SZCZOTKOWANA	<b>1750,00</b>
<b>*OR</b>	ZŁOTY BŁYSZCZĄCY	<b>2700,00</b>

**40335..** BATERIA ZLEWOZMYWAKOWA PODOKIENNA



<b>CR</b>	CHROM	<b>1310,00</b>
<b>*CRSWNE</b>	CHROM+SWAROVSKI	<b>1610,00</b>
<b>BR</b>	STARE ZŁOTO	<b>2115,00</b>
<b>*RA</b>	MIEDŹ SZCZOTKOWANA	<b>2115,00</b>
<b>*OR</b>	ZŁOTY BŁYSZCZĄCY	<b>3100,00</b>

**LAG015ZWW..** ZESTAW WANNOWY PODTYNKOWY



SKŁAD ZESTAWU:  
- DESZCZOWNICA:  
(INDEKS A) C00655 Ø200MM  
- RAMIĘ ŚCIENNE C00684 L-325MM  
- ZESTAW 3W1 EM157



<b>CR</b>	CHROM	<b>2070,00</b>
<b>*CRSWNE</b>	CHROM+SWAROVSKI	<b>2270,00</b>
<b>BR</b>	STARE ZŁOTO	<b>3240,00</b>
<b>*RA</b>	MIEDŹ SZCZOTKOWANA	<b>3240,00</b>
<b>*OR</b>	ZŁOTY BŁYSZCZĄCY	<b>4800,00</b>

**LAG015ZSC1A..** ZESTAW NATRYSKOWY PODTYNKOWY (RAMIĘ 325MM)



**SKŁAD ZESTAWU:**  
 - DESZCZOWNICA:  
 (INDEKS A) C00655  $\varnothing 200\text{MM}$   
 - RAMIĘ ŚCIENNE C00684 L-325MM  
 - ZESTAW NATRYSKOWY C02541  
 - PRZYŁĄCZE KĄTOWE C06908



<b>CR</b>	CHROM	<b>2510,00</b>
<b>*CRSWNE</b>	CHROM+SWAROVSKI	<b>2810,00</b>
<b>BR</b>	STARE ZŁOTO	<b>4150,00</b>
<b>*RA</b>	MIEDŹ SZCZOTKOWANA	<b>4150,00</b>
<b>*OR</b>	ZŁOTY BŁYSZCZĄCY	<b>5900,00</b>

**LAG015ZN1A..** ZESTAW NATRYSKOWY PODTYNKOWY (RAMIĘ 325MM)



**SKŁAD ZESTAWU:**  
 - DESZCZOWNICA:  
 (INDEKS A) C00655  $\varnothing 200\text{MM}$   
 - RAMIĘ ŚCIENNE C00684 L-325MM  
 - ZESTAW 3w1 EM157



<b>CR</b>	CHROM	<b>2300,00</b>
<b>*CRSWNE</b>	CHROM+SWAROVSKI	<b>2800,00</b>
<b>BR</b>	STARE ZŁOTO	<b>3450,00</b>
<b>*RA</b>	MIEDŹ SZCZOTKOWANA	<b>3450,00</b>
<b>*OR</b>	ZŁOTY BŁYSZCZĄCY	<b>4900,00</b>

**LAG015ZSCW1A..** ZESTAW WANNOWY PODTYNKOWY (RAMIĘ 325MM)

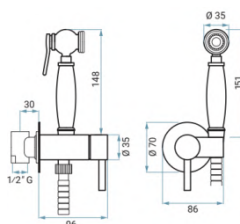

<b>CR</b>	CHROM	<b>580,00</b>
<b>BR</b>	STARE ZŁOTO	<b>1420,00</b>
<b>*RA</b>	MIEDŹ SZCZOTKOWANA	<b>1420,00</b>
<b>*OR</b>	ZŁOTY BŁYSZCZĄCY	<b>1780,00</b>

**179..** BATERIA BIDETOWA PODTYNKOWA

**12100218..**

KOLUMNNA NATRYSKOWA LAGUNA

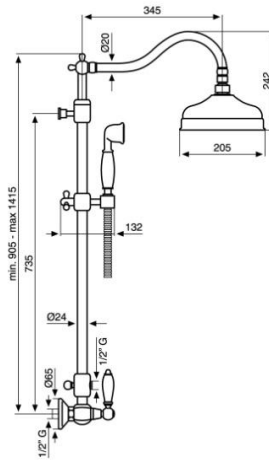

<b>CR</b>	CHROM	<b>3000,00</b>
<b>*CRSWNE</b>	CHROM+SWAROVSKI	<b>3800,00</b>
<b>BR</b>	STARE ZŁOTO	<b>5500,00</b>
<b>*OR</b>	ZŁOTY BŁYSZCZĄCY	<b>7600,00</b>
<b>*RA</b>	MIEDŹ SZCZOTKOWANA	<b>5000,00</b>

**C02541..**

ZESTAW NATRYSKOWY LAGUNA

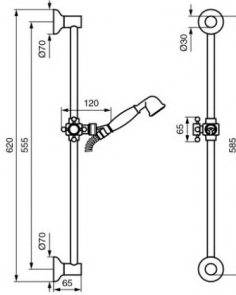

<b>CR</b>	CHROM	<b>580,00</b>
<b>*CO</b>	CHROM/ZŁOTO	<b>1140,00</b>
<b>BR</b>	STARE ZŁOTO	<b>1150,00</b>
<b>*OR</b>	ZŁOTY BŁYSZCZĄCY	<b>1510,00</b>
<b>*RA</b>	MIEDŹ SZCZOTKOWANA	<b>1150,00</b>

**C06908..**

PRZYŁĄCZE KĄTOWE METALOWE

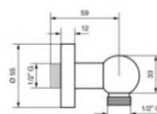

<b>CR</b>	CHROM	<b>215,00</b>
<b>BR</b>	STARE ZŁOTO	<b>405,00</b>
<b>*RA</b>	MIEDŹ SZCZOTKOWANA	<b>405,00</b>
<b>*OR</b>	ZŁOTY BŁYSZCZĄCY	<b>520,00</b>

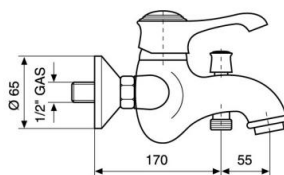

**6001..** BATERIA WANNOWA ŚCIENNA (KORPUS)  
**6001B..** BATERIA WANNOWA ŚCIENNA (KOMPLETNA)

<b>INDEKS 6001</b>		
<b>CR</b>	CHROM	<b>770,00</b>
<b>*CO</b>	CHROM/ZŁOTO	<b>1230,00</b>
<b>BR</b>	STARE ZŁOTO	<b>1230,00</b>
<b>*RA</b>	MIEDŹ SZCZOTKOWANA	<b>1230,00</b>
<b>*OR</b>	ZŁOTY BŁYSZCZĄCY	<b>1800,00</b>

<b>INDEKS 6001B</b>		
<b>CR</b>	CHROM	<b>1000,00</b>
<b>*CO</b>	CHROM/ZŁOTO	<b>1550,00</b>
<b>BR</b>	STARE ZŁOTO	<b>1550,00</b>
<b>*RA</b>	MIEDŹ SZCZOTKOWANA	<b>1550,00</b>
<b>*OR</b>	ZŁOTY BŁYSZCZĄCY	<b>2320,00</b>

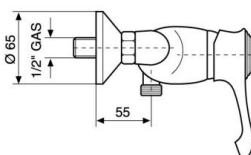

**6002..** BATERIA NATRYSKOWA ŚCIENNA (KORPUS)

<b>CR</b>	CHROM	<b>530,00</b>
<b>*CO</b>	CHROM/ZŁOTO	<b>800,00</b>
<b>BR</b>	STARE ZŁOTO	<b>800,00</b>
<b>*RA</b>	MIEDŹ SZCZOTKOWANA	<b>800,00</b>
<b>*OR</b>	ZŁOTY BŁYSZCZĄCY	<b>1230,00</b>

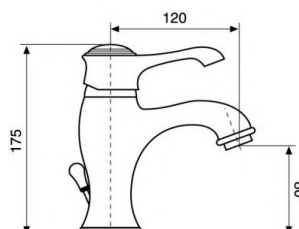

**6003..** BATERIA UMYWALKOWA STOJĄCA (KOREK AUTOMATYCZNY)

<b>CR</b>	CHROM	<b>690,00</b>
<b>*CO</b>	CHROM/ZŁOTO	<b>1150,00</b>
<b>BR</b>	STARE ZŁOTO	<b>1150,00</b>
<b>*RA</b>	MIEDŹ SZCZOTKOWANA	<b>1150,00</b>
<b>*OR</b>	ZŁOTY BŁYSZCZĄCY	<b>1580,00</b>

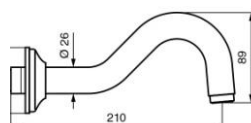

**6009-1029..** BATERIA UMYWALKOWA PODTYNKOWA L-210MM

<b>CR</b>	CHROM	<b>705,00</b>
<b>*CO</b>	CHROM/ZŁOTO	<b>1000,00</b>
<b>BR</b>	STARE ZŁOTO	<b>1000,00</b>
<b>*RA</b>	MIEDŹ SZCZOTKOWANA	<b>1000,00</b>
<b>*OR</b>	ZŁOTY BŁYSZCZĄCY	<b>1480,00</b>

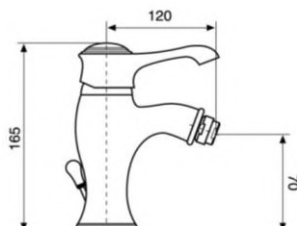

**6004..** BATERIA BIDETOWA STOJĄCA (KOREK AUTOMATYCZNY)

<b>CR</b>	CHROM	<b>690,00</b>
<b>*CO</b>	CHROM/ZŁOTO	<b>1150,00</b>
<b>BR</b>	STARE ZŁOTO	<b>1150,00</b>
<b>*RA</b>	MIEDŹ SZCZOTKOWANA	<b>1150,00</b>
<b>*OR</b>	ZŁOTY BŁYSZCZĄCY	<b>1580,00</b>

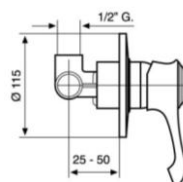

**6009..** BATERIA PODTYNKOWA 1-DROŻNA

<b>CR</b>	CHROM	<b>405,00</b>
<b>*CO</b>	CHROM/ZŁOTO	<b>650,00</b>
<b>BR</b>	STARE ZŁOTO	<b>650,00</b>
<b>*RA</b>	MIEDŹ SZCZOTKOWANA	<b>650,00</b>
<b>*OR</b>	ZŁOTY BŁYSZCZĄCY	<b>900,00</b>

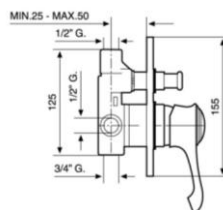

**6019..** BATERIA PODTYNKOWA 2-DROŻNA

<b>CR</b>	CHROM	<b>750,00</b>
<b>*CO</b>	CHROM/ZŁOTO	<b>1100,00</b>
<b>BR</b>	STARE ZŁOTO	<b>1100,00</b>
<b>*RA</b>	MIEDŹ SZCZOTKOWANA	<b>1100,00</b>
<b>*OR</b>	ZŁOTY BŁYSZCZĄCY	<b>1650,00</b>

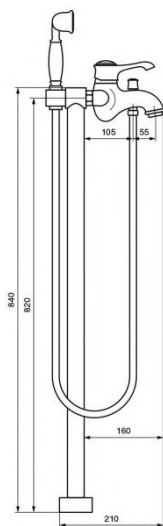

**600128..** BATERIA WANNOWA WOLNOSTOJĄCA



<b>CR</b>	CHROM	<b>3900,00</b>
<b>*CO</b>	CHROM/ZŁOTO	<b>7000,00</b>
<b>BR</b>	STARE ZŁOTO	<b>7000,00</b>
<b>*RA</b>	MIEDŹ SZCZOTKOWANA	<b>7000,00</b>
<b>*OR</b>	ZŁOTY BŁYSZCZĄCY	<b>10600,00</b>



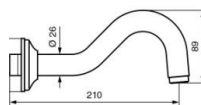

<b>CR</b>	CHROM	<b>1310,00</b>
<b>*CO</b>	CHROM/ZŁOTO	<b>2115,00</b>
<b>BR</b>	STARE ZŁOTO	<b>2115,00</b>
<b>*RA</b>	MIEDŹ SZCZOTKOWANA	<b>2115,00</b>
<b>*OR</b>	ZŁOTY BŁYSZCZĄCY	<b>3100,00</b>

**TIF015ZWW..** ZESTAW WANNOWY PODTYNKOWY



**SKŁAD ZESTAWU:**  
 - DESZCZOWNICA:  
 (INDEKS A) C00655 **Ø200MM**  
 - RAMIĘ ŚCIENNE C00684 L-325MM  
 - ZESTAW 3W1 EM157



<b>CR</b>	CHROM	<b>2070,00</b>
<b>*CO</b>	CHROM/ZŁOTO	<b>3240,00</b>
<b>BR</b>	STARE ZŁOTO	<b>3240,00</b>
<b>*RA</b>	MIEDŹ SZCZOTKOWANA	<b>3240,00</b>
<b>*OR</b>	ZŁOTY BŁYSZCZĄCY	<b>4800,00</b>

**TIF015ZSC1A..** ZESTAW NATRYSKOWY PODTYNKOWY (RAMIĘ 325MM)



**SKŁAD ZESTAWU:**  
 - DESZCZOWNICA:  
 (INDEKS A) C00655 **Ø200MM**  
 - RAMIĘ ŚCIENNE C00684 L-325MM  
 - ZESTAW NATRYSKOWY C02541  
 - PRZYŁĄCZE KĄTOWE C06908



<b>CR</b>	CHROM	<b>2510,00</b>
<b>*CO</b>	CHROM/ZŁOTO	<b>4150,00</b>
<b>BR</b>	STARE ZŁOTO	<b>4150,00</b>
<b>*RA</b>	MIEDŹ SZCZOTKOWANA	<b>4150,00</b>
<b>*OR</b>	ZŁOTY BŁYSZCZĄCY	<b>5900,00</b>

**TIF015ZN1A..** ZESTAW NATRYSKOWY PODTYNKOWY (RAMIĘ 325MM)

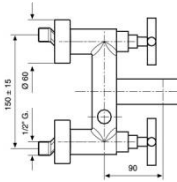

**31001..** BATERIA WANNOWA ŚCIENNA (KORPUS)

<b>*CR</b>	CHROM	<b>1050,00</b>
<b>*NO</b>	CZARNY MAT	<b>1350,00</b>
<b>*RA</b>	MIEDŹ SZCZOTKOWANA	<b>1600,00</b>
<b>*GF</b>	GRAFITOWY	<b>2000,00</b>
<b>*OR</b>	ZŁOTY BŁYSZCZĄCY	<b>2490,00</b>
<b>*ORS</b>	ZŁOTY SZCZOTKOWANY	<b>2700,00</b>

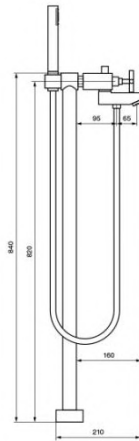

**3100128..** BATERIA WANNOWA WOLNOSTOJĄCA



<b>*CR</b>	CHROM	<b>4300,00</b>
<b>*NO</b>	CZARNY MAT	<b>6400,00</b>
<b>*RA</b>	MIEDŹ SZCZOTKOWANA	<b>7600,00</b>
<b>*GF</b>	GRAFITOWY	<b>9210,00</b>
<b>*OR</b>	ZŁOTY BŁYSZCZĄCY	<b>11600,00</b>
<b>*ORS</b>	ZŁOTY SZCZOTKOWANY	<b>12900,00</b>

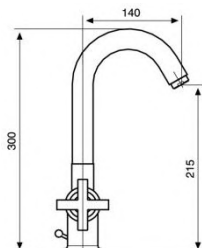

**31003..** BATERIA UMYWALKOWA STOJĄCA (BEZ KORKA)



<b>*CR</b>	CHROM	<b>900,00</b>
<b>*NO</b>	CZARNY MAT	<b>1200,00</b>
<b>*RA</b>	MIEDŹ SZCZOTKOWANA	<b>1410,00</b>
<b>*GF</b>	GRAFITOWY	<b>1700,00</b>
<b>*OR</b>	ZŁOTY BŁYSZCZĄCY	<b>2150,00</b>
<b>*ORS</b>	ZŁOTY SZCZOTKOWANY	<b>2390,00</b>

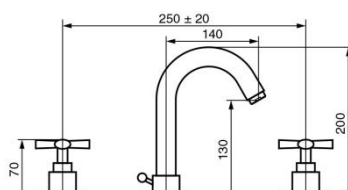

**31033..** BATERIA UMYWALKOWA 3-OTWOROWA



<b>*CR</b>	CHROM	<b>1100,00</b>
<b>*NO</b>	CZARNY MAT	<b>1400,00</b>
<b>*RA</b>	MIEDŹ SZCZOTKOWANA	<b>1750,00</b>
<b>*GF</b>	GRAFITOWY	<b>2100,00</b>
<b>*OR</b>	ZŁOTY BŁYSZCZĄCY	<b>2550,00</b>
<b>*ORS</b>	ZŁOTY SZCZOTKOWANY	<b>2760,00</b>



**31155..**

BATERIA UMYWALKOWA PODTYNKOWA

L-180MM

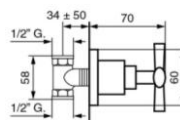

<b>*CR</b>	CHROM	<b>800,00</b>
<b>*NO</b>	CZARNY MAT	<b>1050,00</b>
<b>*RA</b>	MIEDŹ SZCZOTKOWANA	<b>1250,00</b>
<b>*GF</b>	GRAFITOWY	<b>1500,00</b>
<b>*OR</b>	ZŁOTY BŁYSZCZĄCY	<b>1890,00</b>
<b>*ORS</b>	ZŁOTY SZCZOTKOWANY	<b>2090,00</b>



**31121..**

BATERIA WANNOWA 5-OTWOROWA

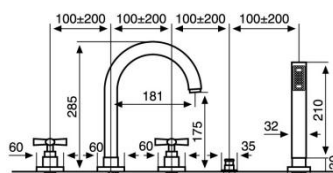

<b>*CR</b>	CHROM	<b>1900,00</b>
<b>*NO</b>	CZARNY MAT	<b>2490,00</b>
<b>*RA</b>	MIEDŹ SZCZOTKOWANA	<b>2900,00</b>
<b>*GF</b>	GRAFITOWY	<b>3490,00</b>
<b>*OR</b>	ZŁOTY BŁYSZCZĄCY	<b>4390,00</b>
<b>*ORS</b>	ZŁOTY SZCZOTKOWANY	<b>4850,00</b>



**SPI015ZWW..**

ZESTAW WANNOWY PODTYNKOWY

SKŁAD ZESTAWU:  
- ZESTAW 3W1 ZDUP094  
- WYLEWKA ŚCIENNA L-180MM



<b>*CR</b>	CHROM	<b>1900,00</b>
<b>*NO</b>	CZARNY MAT	<b>2600,00</b>
<b>*RA</b>	MIEDŹ SZCZOTKOWANA	<b>2750,00</b>
<b>*GF</b>	GRAFITOWY	<b>3200,00</b>
<b>*OR</b>	ZŁOTY BŁYSZCZĄCY	<b>4000,00</b>
<b>*ORS</b>	ZŁOTY SZCZOTKOWANY	<b>4550,00</b>



**SPI015ZSC3..**

ZESTAW NATRYSKOWY PODTYNKOWY

SKŁAD ZESTAWU:  
- DESZCZOWNICA:  
(INDEKS A) ZSOF074 Ø225MM -PAFFONI-  
(INDEKS G) C06657 Ø250MM  
- RAMIĘ ŚCIENNE L-400MM  
- ZESTAW 3W1



	INDEKS A ZSOF074 Ø225mm	
<b>CR</b>	CHROM	<b>2300,00</b>
<b>NO</b>	CZARNY MAT	<b>3700,00</b>

	INDEKS G C06657-25 Ø250mm	
<b>*CR</b>	CHROM	<b>2490,00</b>
<b>*NO</b>	CZARNY MAT	<b>3900,00</b>
<b>*RA</b>	MIEDŹ SZCZOTKOWANA	<b>4200,00</b>
<b>*GF</b>	GRAFITOWY	<b>5050,00</b>
<b>*OR</b>	ZŁOTY BŁYSZCZĄCY	<b>6200,00</b>
<b>*ORS</b>	ZŁOTY SZCZOTKOWANY	<b>7000,00</b>



**45001..**  
**45001B..**

BATERIA WANNOWA ŚCIENNA (KORPUS)  
BATERIA WANNOWA ŚCIENNA (KOMPLETNA)

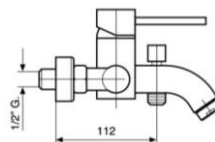

### INDEKS 45001

<b>CR</b>	CHROM	<b>640,00</b>
<b>BIO</b>	BIAŁY MAT	<b>850,00</b>
<b>NO</b>	CZARNY MAT	<b>850,00</b>
<b>*RA</b>	MIEDŹ SZCZOTKOWANA	<b>990,00</b>
<b>*BR</b>	STARE ŻŁOTO	<b>990,00</b>
<b>*GF</b>	GRAFITOWY	<b>1200,00</b>
<b>OR</b>	ZŁOTY BŁYSZCZĄCY	<b>1470,00</b>

### INDEKS 45001B

<b>CR</b>	CHROM	<b>990,00</b>
<b>BIO</b>	BIAŁY MAT	<b>1280,00</b>
<b>NO</b>	CZARNY MAT	<b>1280,00</b>
<b>*RA</b>	MIEDŹ SZCZOTKOWANA	<b>1520,00</b>
<b>*BR</b>	STARE ŻŁOTO	<b>1520,00</b>
<b>*GF</b>	GRAFITOWY	<b>1850,00</b>
<b>OR</b>	ZŁOTY BŁYSZCZĄCY	<b>2300,00</b>



**45030..**

BATERIA WANNOWA WOLNOSTOJĄCA (KOMPLETNA)



**CR** CHROM **2790,00**



**45002..**

BATERIA NATRYSKOWA ŚCIENNA (KORPUS)

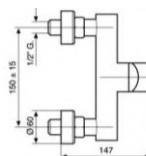

<b>CR</b>	CHROM	<b>450,00</b>
<b>BIO</b>	BIAŁY MAT	<b>610,00</b>
<b>NO</b>	CZARNY MAT	<b>610,00</b>
<b>*RA</b>	MIEDŹ SZCZOTKOWANA	<b>750,00</b>
<b>*BR</b>	STARE ŻŁOTO	<b>750,00</b>
<b>*GF</b>	GRAFITOWY	<b>880,00</b>
<b>OR</b>	ZŁOTY BŁYSZCZĄCY	<b>1100,00</b>

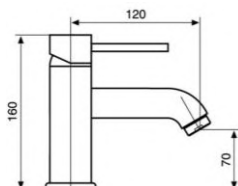

**45003..**

BATERIA UMYWALKOWA STOJĄCA (BEZ KORKA)

**45003K..**

BATERIA UMYWALKOWA STOJĄCA (KOREK CLICK CLACK)

**INDEKS 45003**

<b>CR</b>	CHROM	<b>420,00</b>
<b>BIO</b>	BIAŁY MAT	<b>610,00</b>
<b>NO</b>	CZARNY MAT	<b>610,00</b>
<b>*RA</b>	MIEDŹ SZCZOTKOWANA	<b>710,00</b>
<b>*BR</b>	STARE ŻŁOTO	<b>710,00</b>
<b>*GF</b>	GRAFITOWY	<b>860,00</b>
<b>OR</b>	ZŁOTY BŁYSZCZĄCY	<b>1070,00</b>

**INDEKS 45003K**

<b>CR</b>	CHROM	<b>500,00</b>
<b>BIO</b>	BIAŁY MAT	<b>740,00</b>
<b>NO</b>	CZARNY MAT	<b>740,00</b>
<b>*RA</b>	MIEDŹ SZCZOTKOWANA	<b>960,00</b>
<b>*BR</b>	STARE ŻŁOTO	<b>960,00</b>
<b>*GF</b>	GRAFITOWY	<b>1150,00</b>
<b>OR</b>	ZŁOTY BŁYSZCZĄCY	<b>1420,00</b>

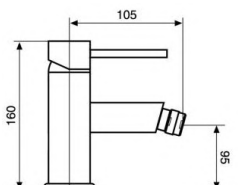

**45004..**

BATERIA BIDETOWA STOJĄCA (BEZ KORKA)

**45004K..**

BATERIA BIDETOWA STOJĄCA (KOREK CLICK CLACK)

**INDEKS 45004**

<b>CR</b>	CHROM	<b>420,00</b>
<b>BIO</b>	BIAŁY MAT	<b>610,00</b>
<b>NO</b>	CZARNY MAT	<b>610,00</b>
<b>*RA</b>	MIEDŹ SZCZOTKOWANA	<b>710,00</b>
<b>*BR</b>	STARE ŻŁOTO	<b>710,00</b>
<b>*GF</b>	GRAFITOWY	<b>860,00</b>
<b>OR</b>	ZŁOTY BŁYSZCZĄCY	<b>1070,00</b>

**INDEKS 45004K**

<b>CR</b>	CHROM	<b>500,00</b>
<b>BIO</b>	BIAŁY MAT	<b>740,00</b>
<b>NO</b>	CZARNY MAT	<b>740,00</b>
<b>*RA</b>	MIEDŹ SZCZOTKOWANA	<b>960,00</b>
<b>*BR</b>	STARE ŻŁOTO	<b>960,00</b>
<b>*GF</b>	GRAFITOWY	<b>1150,00</b>
<b>OR</b>	ZŁOTY BŁYSZCZĄCY	<b>1420,00</b>

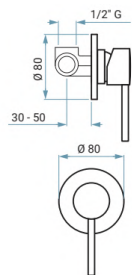

**45009PI..**

BATERIA PODTYNKOWA 1-DROŻNA

<b>CR</b>	CHROM	<b>350,00</b>
<b>BIO</b>	BIAŁY MAT	<b>480,00</b>
<b>NO</b>	CZARNY MAT	<b>480,00</b>
<b>*RA</b>	MIEDŹ SZCZOTKOWANA	<b>550,00</b>
<b>*BR</b>	STARE ŻŁOTO	<b>550,00</b>
<b>*GF</b>	GRAFITOWY	<b>650,00</b>
<b>OR</b>	ZŁOTY BŁYSZCZĄCY	<b>800,00</b>

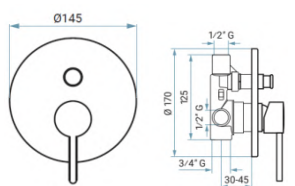

**45019..**

BATERIA PODTYNKOWA 2-DROŻNA

<b>CR</b>	CHROM	<b>600,00</b>
<b>BIO</b>	BIAŁY MAT	<b>800,00</b>
<b>NO</b>	CZARNY MAT	<b>800,00</b>
<b>*RA</b>	MIEDŹ SZCZOTKOWANA	<b>900,00</b>
<b>*BR</b>	STARE ŻŁOTO	<b>900,00</b>
<b>*GF</b>	GRAFITOWY	<b>1100,00</b>
<b>OR</b>	ZŁOTY BŁYSZCZĄCY	<b>1390,00</b>

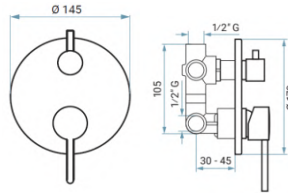

**45029..** BATERIA PODTYNKOWA 3-DROŻNA

<b>CR</b>	CHROM	<b>750,00</b>
<b>BIO</b>	BIAŁY MAT	<b>950,00</b>
<b>NO</b>	CZARNY MAT	<b>950,00</b>
<b>*RA</b>	MIEDŹ SZCZOTKOWANA	<b>1080,00</b>
<b>*BR</b>	STARE ŻŁOTO	<b>1080,00</b>
<b>*GF</b>	GRAFITOWY	<b>1320,00</b>
<b>OR</b>	ŻŁOTY BŁYSZCZĄCY	<b>1650,00</b>

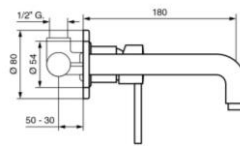

**45055-18..** BATERIA UMYWALKOWA PODTYNKOWA L-18CM

**45055-25..** BATERIA UMYWALKOWA PODTYNKOWA L-25CM

<b>CR</b>	CHROM	<b>520,00</b>
<b>BIO</b>	BIAŁY MAT	<b>650,00</b>
<b>NO</b>	CZARNY MAT	<b>650,00</b>
<b>*RA</b>	MIEDŹ SZCZOTKOWANA	<b>800,00</b>
<b>*BR</b>	STARE ŻŁOTO	<b>800,00</b>
<b>*GF</b>	GRAFITOWY	<b>920,00</b>
<b>OR</b>	ŻŁOTY BŁYSZCZĄCY	<b>1150,00</b>

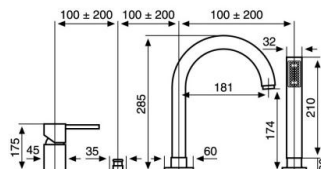

**45120..** BATERIA WANNOWA 4-OTWOROWA



<b>CR</b>	CHROM	<b>1500,00</b>
<b>BIO</b>	BIAŁY MAT	<b>1950,00</b>
<b>NO</b>	CZARNY MAT	<b>1950,00</b>
<b>*RA</b>	MIEDŹ SZCZOTKOWANA	<b>2300,00</b>
<b>*BR</b>	STARE ŻŁOTO	<b>2300,00</b>
<b>*GF</b>	GRAFITOWY	<b>2750,00</b>
<b>OR</b>	ŻŁOTY BŁYSZCZĄCY	<b>3415,00</b>

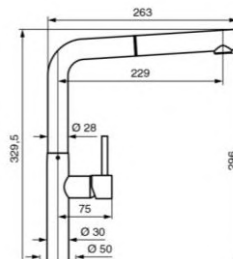

**78066P..** BATERIA ZLEWOZMYWAKOWA Z WYCIĄGANĄ WYLEWKĄ



<b>*CR</b>	CHROM	<b>1100,00</b>
<b>*BIO</b>	BIAŁY MAT	<b>1400,00</b>
<b>NO</b>	CZARNY MAT	<b>1400,00</b>

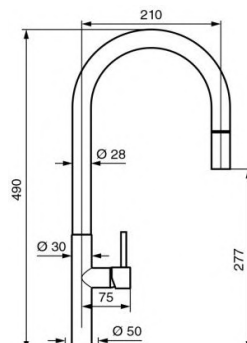

**78067P..**

BATERIA ZLEWOZMYWAKOWA Z WYCIĄGANĄ WYLEWKĄ



<b>CR</b>	CHROM	<b>1300,00</b>
<b>BIO</b>	BIAŁY MAT	<b>1700,00</b>
<b>NO</b>	CZARNY MAT	<b>1700,00</b>
<b>*RA</b>	MIEDŹ SZCZOTKOWANA	<b>2200,00</b>
<b>*BR</b>	STARE ZŁOTO	<b>2200,00</b>
<b>*GF</b>	GRAFITOWY	<b>2900,00</b>
<b>OR</b>	ZŁOTY BŁYSZCZĄCY	<b>3100,00</b>

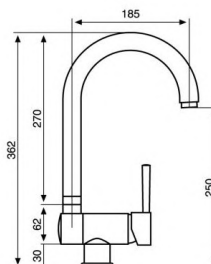

**45335..**

BATERIA ZLEWOZMYWAKOWA PODOKIENNA



<b>*CR</b>	CHROM	<b>880,00</b>
<b>*BIO</b>	BIAŁY MAT	<b>1180,00</b>
<b>NO</b>	CZARNY MAT	<b>1180,00</b>
<b>*RA</b>	MIEDŹ SZCZOTKOWANA	<b>1400,00</b>
<b>*BR</b>	STARE ZŁOTO	<b>1400,00</b>
<b>*GF</b>	GRAFITOWY	<b>1700,00</b>
<b>*OR</b>	ZŁOTY BŁYSZCZĄCY	<b>2080,00</b>

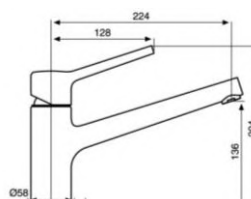

**75007..**

BATERIA ZLEWOZMYWAKOWA STOJĄCA



<b>CR</b>	CHROM	<b>750,00</b>
<b>*BIO</b>	BIAŁY MAT	<b>1150,00</b>
<b>*NO</b>	CZARNY MAT	<b>1150,00</b>



SKŁAD ZESTAWU:  
- ZESTAW 3W1  
- WYLEWKA ŚCIENNA L-180MM



<b>CR</b>	CHROM	<b>1400,00</b>
<b>BIO</b>	BIAŁY MAT	<b>1910,00</b>
<b>NO</b>	CZARNY MAT	<b>1910,00</b>
<b>*RA</b>	MIEDŹ SZCZOTKOWANA	<b>2000,00</b>
<b>*BR</b>	STARE ZŁOTO	<b>2000,00</b>
<b>*GF</b>	GRAFITOWY	<b>2400,00</b>
<b>OR</b>	ZŁOTY BŁYSZCZĄCY	<b>3000,00</b>

**PI010ZWW..**

ZESTAW WANNOWY PODTYNKOWY



**SKŁAD ZESTAWU:**  
- ZESTAW 3W1  
- WYLEWKA ŚCIENNA L-180MM

**PI015ZWW..** ZESTAW WANNOWY PODTYNKOWY



<b>CR</b>	CHROM	1400,00
<b>BIO</b>	BIAŁY MAT	1890,00
<b>NO</b>	CZARNY MAT	1890,00
<b>*RA</b>	MIEDŹ SZCZOTKOWANA	2050,00
<b>*BR</b>	STARE ZŁOTO	2050,00
<b>*GF</b>	GRAFITOWY	2500,00
<b>OR</b>	ZŁOTY BŁYSZCZĄCY	3000,00



**INDEKS A ZSOF074 Ø225mm**

<b>CR</b>	CHROM	1600,00
<b>NO</b>	CZARNY MAT	2360,00



**SKŁAD ZESTAWU:**  
- DESZCZOWNICA:  
(INDEKS A) ZSOF074 Ø225MM –PAFFONI-  
(INDEKS E) C06657-30 Ø300MM  
(INDEKS G) C06657-25 Ø250MM  
- RAMIĘ ŚCIENNE L-400MM  
- ZESTAW 3W1

**INDEKS E C06657-30 Ø300mm**

<b>CR</b>	CHROM	2000,00
<b>BIO</b>	BIAŁY MAT	3600,00
<b>NO</b>	CZARNY MAT	3600,00
<b>*RA</b>	MIEDŹ SZCZOTKOWANA	3900,00
<b>*BR</b>	STARE ZŁOTO	3900,00
<b>*GF</b>	GRAFITOWY	5200,00
<b>OR</b>	ZŁOTY BŁYSZCZĄCY	5900,00

**INDEKS G C06657-25 Ø250mm**

<b>*CR</b>	CHROM	2050,00
<b>BIO</b>	BIAŁY MAT	3400,00
<b>*RA</b>	MIEDŹ SZCZOTKOWANA	3400,00
<b>*BR</b>	STARE ZŁOTO	3400,00
<b>*GF</b>	GRAFITOWY	4400,00
<b>OR</b>	ZŁOTY BŁYSZCZĄCY	5300,00

**PI015ZSC3..** ZESTAW NATRYSKOWY PODTYNKOWY (RAMIĘ 400MM)



**INDEKS A ZSOF074 Ø225mm**

<b>CR</b>	CHROM	1600,00
<b>NO</b>	CZARNY MAT	2390,00

**INDEKS E C06657-30 Ø300mm**

<b>CR</b>	CHROM	2510,00
<b>BIO</b>	BIAŁY MAT	3800,00
<b>NO</b>	CZARNY MAT	3800,00
<b>*RA</b>	MIEDŹ SZCZOTKOWANA	3900,00
<b>*BR</b>	STARE ZŁOTO	3900,00
<b>*GF</b>	GRAFITOWY	5200,00
<b>OR</b>	ZŁOTY BŁYSZCZĄCY	6000,00

**INDEKS G C06657-25 Ø250mm**

<b>*CR</b>	CHROM	2000,00
<b>BIO</b>	BIAŁY MAT	3300,00
<b>*RA</b>	MIEDŹ SZCZOTKOWANA	3500,00
<b>*BR</b>	STARE ZŁOTO	3500,00
<b>*GF</b>	GRAFITOWY	4300,00
<b>OR</b>	ZŁOTY BŁYSZCZĄCY	5200,00



**SKŁAD ZESTAWU:**  
- DESZCZOWNICA:  
(INDEKS A) ZSOF074 Ø225MM –PAFFONI-  
(INDEKS E) C06657-30 Ø300MM  
(INDEKS G) C06657-25 Ø250MM  
- RAMIĘ ŚCIENNE L-400MM  
- ZESTAW 3W1

**PI010ZSC3..** ZESTAW NATRYSKOWY PODTYNKOWY (RAMIĘ 400MM)





**PI019ZSCW3..** ZESTAW WANNOWY PODTYNKOWY (RAMIĘ 400MM)

**SKŁAD ZESTAWU:**

- DESZCZOWNICA:  
(INDEKS A) ZSOF074 **Ø225MM** –PAFFONI-
- (INDEKS E) C06657-30 **Ø300MM**
- (INDEKS G) C06657-25 **Ø250MM**
- RAMIĘ ŚCIENNE L-400MM
- ZESTAW 3W1
- WYLEWKA ŚCIENNA L-180MM



**INDEKS A ZSOF074 Ø225mm**

<b>CR</b>	CHROM	<b>2050,00</b>
<b>NO</b>	CZARNY MAT	<b>2950,00</b>

**INDEKS E C06657-30 Ø300mm**

<b>CR</b>	CHROM	<b>2435,00</b>
<b>BIO</b>	BIAŁY MAT	<b>4190,00</b>
<b>NO</b>	CZARNY MAT	<b>4190,00</b>
<b>*RA</b>	MIEDŹ SZCZOTKOWANA	<b>4400,00</b>
<b>*BR</b>	STARE ŻŁOTO	<b>4400,00</b>
<b>*GF</b>	GRAFITOWY	<b>5900,00</b>
<b>OR</b>	ŻŁOTY BŁYSZCZĄCY	<b>6000,00</b>

**INDEKS G C06657-25 Ø250mm**

<b>*CR</b>	CHROM	<b>2300,00</b>
<b>BIO</b>	BIAŁY MAT	<b>3100,00</b>
<b>*RA</b>	MIEDŹ SZCZOTKOWANA	<b>4050,00</b>
<b>*BR</b>	STARE ŻŁOTO	<b>4050,00</b>
<b>*GF</b>	GRAFITOWY	<b>5200,00</b>
<b>OR</b>	ŻŁOTY BŁYSZCZĄCY	<b>5590,00</b>



**PI019ZWSCSU3..** ZESTAW WANNOWY PODTYNKOWY (RAMIĘ 400MM)

**SKŁAD ZESTAWU:**

- DESZCZOWNICA:  
(INDEKS A) ZSOF074 **Ø225MM** –PAFFONI-
- (INDEKS E) C06657-30 **Ø300MM**
- (INDEKS G) C06657-25 **Ø250MM**
- RAMIĘ ŚCIENNE L-400MM
- ZESTAW 3W1
- SYFON WANNOWY Z NAPELNIENIEM PRZEZ PRZELEW D6



**INDEKS A ZSOF074 Ø225mm**

<b>CR</b>	CHROM	<b>2285,00</b>
<b>NO</b>	CZARNY MAT	<b>3360,00</b>

**INDEKS E C06657-30 Ø300mm**

<b>CR</b>	CHROM	<b>2655,00</b>
<b>BIO</b>	BIAŁY MAT	<b>4650,00</b>
<b>NO</b>	CZARNY MAT	<b>4650,00</b>
<b>OR</b>	ŻŁOTY BŁYSZCZĄCY	<b>6770,00</b>

**INDEKS G C06657-25 Ø250mm**

<b>*CR</b>	CHROM	<b>2600,00</b>
<b>BIO</b>	BIAŁY MAT	<b>4400,00</b>
<b>OR</b>	ŻŁOTY BŁYSZCZĄCY	<b>6400,00</b>





**85001..** BATERIA WANNOWA ŚCIENNA (KORPUS)

**\*INOX** INOX - STAL AISI 304 **1150,00**

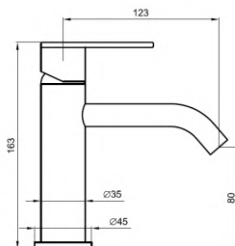

**85003..** BATERIA UMYWALKOWA STOJĄCA (KOREK CLICK CLACK)

**INOX** INOX - STAL AISI 304 **880,00**

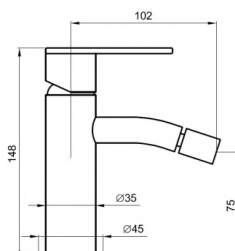

**85004..** BATERIA BIDETOWA STOJĄCA (KOREK CLICK CLACK)

**\*INOX** INOX - STAL AISI 304 **940,00**

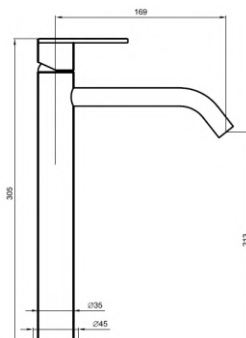

**85003BIG..** BATERIA UMYWALKOWA WYSOKA (KOREK CLICK CLACK)

**\*INOX** INOX - STAL AISI 304 **950,00**

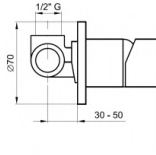

**85009..**

BATERIA PODTYNKOWA 1-DROŻNA

**\*INOX** INOX - STAL AISI 304 **480,00**

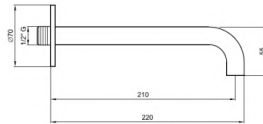
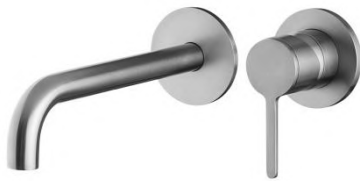

**85155..**

BATERIA UMYWALKOWA PODTYNKOWA **L-210MM** (KOREK CLICK CLACK)

**\*INOX** INOX - STAL AISI 304 **1220,00**



**SKŁAD ZESTAWU:**  
- ZESTAW 3W1 EM154  
- WYLEWKA ŚCIENNA **L-210MM**

**FILO10ZWW..**

ZESTAW WANNOWY PODTYNKOWY

**\*INOX** INOX - STAL AISI 304 **2400,00**



**SKŁAD ZESTAWU:**  
- DESZCZOWNICA:  
(INDEKS **Z**) C06650 **Ø250MM**  
- RAMIĘ ŚCIENNE **L-330MM**  
- ZESTAW 3W1 EM154

**FILO15ZSC3Z..** ZESTAW NATRYSKOWY PODTYNKOWY (RAMIĘ 330MM)

**\*INOX** INOX - STAL AISI 304 **3150,00**



- SKŁAD ZESTAWU:  
 - DESZCZOWNICA:  
 (INDEKS Z) C06650 Ø250MM  
 - RAMIĘ ŚCIENNE L-330MM  
 - ZESTAW 3W1 EM154  
 - WYLEWKA ŚCIENNA L-210MM

**FILO15ZSCW3Z..** ZESTAW WANNOWY PODTYNKOWY

**\*INOX** INOX - STAL AISI 304 **4080,00**



**C02668..**

ZESTAW NATRYSKOWY **FILO**

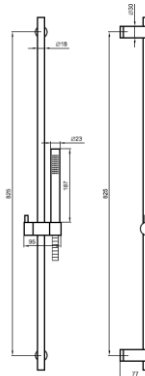

**\*INOX** INOX - STAL AISI 304 **2090,00**



**EM167..**

ZESTAW 2W1 **FILO**

**\*INOX** INOX - STAL AISI 304 **820,00**



**C06910..**

PRZYŁĄCZE KĄTOWE METALOWE

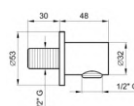

**\*INOX** INOX - STAL AISI 304 **490,00**



UCHWYT FILO



UCHWYT FILO ZI



**INDEKS 85001**

<b>*CR</b>	CHROM	<b>1400,00</b>
<b>*BIO</b>	BIAŁY MAT	<b>1750,00</b>
<b>*NO</b>	CZARNY MAT	<b>1750,00</b>
<b>*RA</b>	MIEDŹ SZCZOTKOWANA	<b>2000,00</b>
<b>*GF</b>	GRAFITOWY	<b>2400,00</b>
<b>TS</b>	TUSCAN	<b>2400,00</b>
<b>*ORSP</b>	ZŁOTY SZCZOTKOWANY	<b>3350,00</b>



**85001..**

BATERIA WANNOWA ŚCIENNA (KORPUS)

**85001B..**

BATERIA WANNOWA ŚCIENNA (KOMPLETNA)

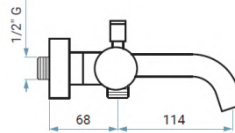

**INDEKS 85001B**

<b>*CR</b>	CHROM	<b>1800,00</b>
<b>*BIO</b>	BIAŁY MAT	<b>2200,00</b>
<b>*NO</b>	CZARNY MAT	<b>2200,00</b>
<b>*RA</b>	MIEDŹ SZCZOTKOWANA	<b>2600,00</b>
<b>*GF</b>	GRAFITOWY	<b>3100,00</b>
<b>TS</b>	TUSCAN	<b>3100,00</b>
<b>*ORSP</b>	ZŁOTY SZCZOTKOWANY	<b>4300,00</b>



**85003..**

BATERIA UMYWALKOWA STOJĄCA (KOREK CLICK CLACK)

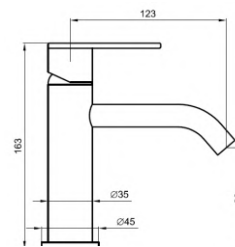

<b>*CR</b>	CHROM	<b>860,00</b>
<b>*BIO</b>	BIAŁY MAT	<b>1100,00</b>
<b>*NO</b>	CZARNY MAT	<b>1100,00</b>
<b>*RA</b>	MIEDŹ SZCZOTKOWANA	<b>1300,00</b>
<b>*GF</b>	GRAFITOWY	<b>1590,00</b>
<b>TS</b>	TUSCAN	<b>1590,00</b>
<b>*ORSP</b>	ZŁOTY SZCZOTKOWANY	<b>2200,00</b>



**85004..**

BATERIA BIDETOWA STOJĄCA (KOREK CLICK CLACK)

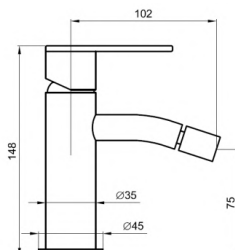

<b>*CR</b>	CHROM	<b>860,00</b>
<b>*BIO</b>	BIAŁY MAT	<b>1100,00</b>
<b>*NO</b>	CZARNY MAT	<b>1100,00</b>
<b>*RA</b>	MIEDŹ SZCZOTKOWANA	<b>1300,00</b>
<b>*GF</b>	GRAFITOWY	<b>1590,00</b>
<b>TS</b>	TUSCAN	<b>1590,00</b>
<b>*ORSP</b>	ZŁOTY SZCZOTKOWANY	<b>2200,00</b>

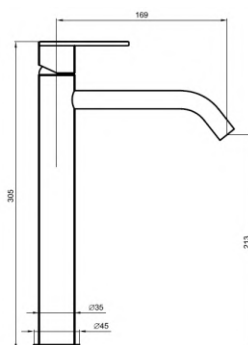

**85003BIG..** BATERIA UMYWALKOWA WYSOKA (KOREK CLICK CLACK)

<b>*CR</b>	CHROM	<b>1300,00</b>
<b>*BIO</b>	BIAŁY MAT	<b>1650,00</b>
<b>*NO</b>	CZARNY MAT	<b>1650,00</b>
<b>*RA</b>	MIEDŹ SZCZOTKOWANA	<b>1990,00</b>
<b>*GF</b>	GRAFITOWY	<b>2200,00</b>
<b>TS</b>	TUSCAN	<b>2200,00</b>
<b>*ORSP</b>	ZŁOTY SZCZOTKOWANY	<b>3100,00</b>

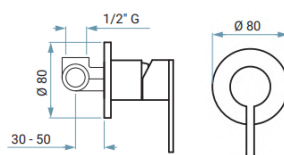

**85009PI..** BATERIA PODTYNKOWA 1-DROŻNA

<b>*CR</b>	CHROM	<b>480,00</b>
<b>*BIO</b>	BIAŁY MAT	<b>600,00</b>
<b>*NO</b>	CZARNY MAT	<b>600,00</b>
<b>*RA</b>	MIEDŹ SZCZOTKOWANA	<b>680,00</b>
<b>*GF</b>	GRAFITOWY	<b>820,00</b>
<b>TS</b>	TUSCAN	<b>820,00</b>
<b>*ORSP</b>	ZŁOTY SZCZOTKOWANY	<b>1150,00</b>

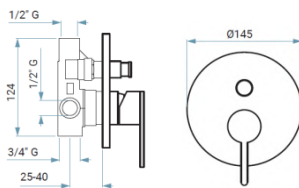

**85019..** BATERIA PODTYNKOWA 2-DROŻNA

<b>*CR</b>	CHROM	<b>750,00</b>
<b>*BIO</b>	BIAŁY MAT	<b>950,00</b>
<b>*NO</b>	CZARNY MAT	<b>950,00</b>
<b>*RA</b>	MIEDŹ SZCZOTKOWANA	<b>1080,00</b>
<b>*GF</b>	GRAFITOWY	<b>1300,00</b>
<b>TS</b>	TUSCAN	<b>1300,00</b>
<b>*ORSP</b>	ZŁOTY SZCZOTKOWANY	<b>1800,00</b>

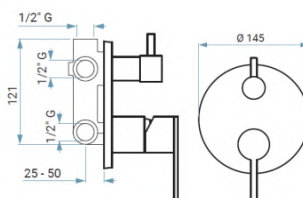

**85029..** BATERIA PODTYNKOWA 3-DROŻNA

<b>*CR</b>	CHROM	<b>900,00</b>
<b>*BIO</b>	BIAŁY MAT	<b>1100,00</b>
<b>*NO</b>	CZARNY MAT	<b>1100,00</b>
<b>*RA</b>	MIEDŹ SZCZOTKOWANA	<b>4400,00</b>
<b>*GF</b>	GRAFITOWY	<b>1240,00</b>
<b>TS</b>	TUSCAN	<b>1240,00</b>
<b>*ORSP</b>	ZŁOTY SZCZOTKOWANY	<b>2100,00</b>

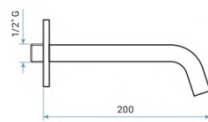

**85155..** BATERIA UMYWALKOWA PODTYNKOWA (ZINTEGROWANA) L-190MM

<b>*CR</b>	CHROM	<b>950,00</b>
<b>*BIO</b>	BIAŁY MAT	<b>1150,00</b>
<b>*NO</b>	CZARNY MAT	<b>1150,00</b>
<b>*RA</b>	MIEDŹ SZCZOTKOWANA	<b>1320,00</b>
<b>*GF</b>	GRAFITOWY	<b>1600,00</b>
<b>TS</b>	TUSCAN	<b>1600,00</b>
<b>*ORSP</b>	ZŁOTY SZCZOTKOWANY	<b>2250,00</b>

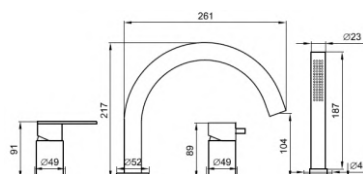

**85120..**

BATERIA WANNOWA 4-OTWOROWA

<b>*CR</b>	CHROM	<b>1850,00</b>
<b>*BIO</b>	BIAŁY MAT	<b>2300,00</b>
<b>*NO</b>	CZARNY MAT	<b>2300,00</b>
<b>*RA</b>	MIEDŹ SZCZOTKOWANA	<b>2680,00</b>
<b>*GF</b>	GRAFITOWY	<b>3300,00</b>
<b>TS</b>	TUSCAN	<b>3300,00</b>
<b>*ORSP</b>	ZŁOTY SZCZOTKOWANY	<b>4550,00</b>



**85023..**

BATERIA UMYWALKOWA WOLNOSTOJĄCA

<b>*CR</b>	CHROM	<b>3800,00</b>
<b>*BIO</b>	BIAŁY MAT	<b>4900,00</b>
<b>*NO</b>	CZARNY MAT	<b>4900,00</b>
<b>*RA</b>	MIEDŹ SZCZOTKOWANA	<b>5400,00</b>
<b>*GF</b>	GRAFITOWY	<b>6400,00</b>
<b>*TS</b>	TUSCAN	<b>6400,00</b>
<b>*ORSP</b>	ZŁOTY SZCZOTKOWANY	<b>8400,00</b>



**85030..**

BATERIA WANNOWA WOLNOSTOJĄCA



<b>*CR</b>	CHROM	<b>4700,00</b>
<b>*BIO</b>	BIAŁY MAT	<b>5900,00</b>
<b>*NO</b>	CZARNY MAT	<b>5900,00</b>
<b>*RA</b>	MIEDŹ SZCZOTKOWANA	<b>6800,00</b>
<b>*GF</b>	GRAFITOWY	<b>7700,00</b>
<b>*TS</b>	TUSCAN	<b>7700,00</b>
<b>*ORSP</b>	ZŁOTY SZCZOTKOWANY	<b>10600,00</b>



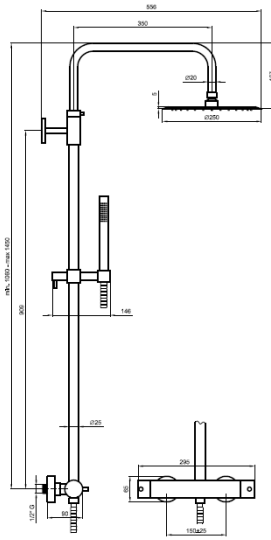

**4530784..** KOLUMNA NATRYSKOWA TERMOSTATYCZNA



<b>*CR</b>	CHROM	<b>3100,00</b>
<b>*BIO</b>	BIAŁY MAT	<b>4600,00</b>
<b>*NO</b>	CZARNY MAT	<b>4600,00</b>
<b>*RA</b>	MIEDŹ SZCZOTKOWANA	<b>5555,00</b>
<b>*GF</b>	GRAFITOWY	<b>6600,00</b>
<b>*TS</b>	TUSCAN	<b>6600,00</b>
<b>*ORSP</b>	ZŁOTY SZCZOTKOWANY	<b>9400,00</b>



**SKŁAD ZESTAWU:**  
- ZESTAW 3w1  
- WYLEWKA ŚCIENNA L-180MM

**FILO10ZWW..** ZESTAW WANNOWY PODTYNKOWY



<b>*CR</b>	CHROM	<b>1720,00</b>
<b>*BIO</b>	BIAŁY MAT	<b>2300,00</b>
<b>*NO</b>	CZARNY MAT	<b>2300,00</b>
<b>*RA</b>	MIEDŹ SZCZOTKOWANA	<b>2650,00</b>
<b>*GF</b>	GRAFITOWY	<b>3100,00</b>
<b>TS</b>	TUSCAN	<b>3100,00</b>
<b>*ORSP</b>	ZŁOTY SZCZOTKOWANY	<b>4400,00</b>



**SKŁAD ZESTAWU:**  
- ZESTAW 3w1  
- WYLEWKA ŚCIENNA L-180MM

**FILO15ZWW..** ZESTAW WANNOWY PODTYNKOWY



<b>*CR</b>	CHROM	<b>1490,00</b>
<b>*BIO</b>	BIAŁY MAT	<b>2050,00</b>
<b>*NO</b>	CZARNY MAT	<b>2050,00</b>
<b>*RA</b>	MIEDŹ SZCZOTKOWANA	<b>2400,00</b>
<b>*GF</b>	GRAFITOWY	<b>2790,00</b>
<b>TS</b>	TUSCAN	<b>2790,00</b>
<b>*ORSP</b>	ZŁOTY SZCZOTKOWANY	<b>3900,00</b>



SKŁAD ZESTAWU:  
 - DESZCZOWNICA:  
 (INDEKS A) ZSOF074 Ø225MM -PAFFONI-  
 (INDEKS G) C06657-25 Ø250MM  
 - RAMIĘ ŚCIENNE L-400MM  
 - ZESTAW 3W1

**FIL015ZSC3..** ZESTAW NATRYSKOWY PODTYNKOWY



INDEKS A ZSOF074 Ø225mm  
**\*CR** CHROM 1750,00  
**\*NO** CZARNY MAT 2550,00

INDEKS G C06657-25 Ø250mm  
**\*CR** CHROM 2200,00  
**\*BIO** BIAŁY MAT 3400,00  
**\*NO** CZARNY MAT 3400,00  
**\*RA** MIEDŹ SZCZOTKOWANA 3800,00  
**\*GF** GRAFITOWY 4300,00  
**TS** TUSCAN 4300,00  
**\*ORSP** ŻŁOTY SZCZOTKOWANY 6000,00



SKŁAD ZESTAWU:  
 - DESZCZOWNICA:  
 (INDEKS A) ZSOF074 Ø225MM -PAFFONI-  
 (INDEKS G) C06657-25 Ø250MM  
 - RAMIĘ ŚCIENNE L-400MM  
 - ZESTAW 3W1  
 - WYLEWKA ŚCIENNA L-180MM

**FIL019ZSCW3..** ZESTAW NATRYSKOWY PODTYNKOWY



INDEKS A ZSOF074 Ø225mm  
**\*CR** CHROM 2300,00  
**\*NO** CZARNY MAT 3000,00

INDEKS G C06657-25 Ø250mm  
**\*CR** CHROM 2700,00  
**\*BIO** BIAŁY MAT 3900,00  
**\*NO** CZARNY MAT 3900,00  
**\*RA** MIEDŹ SZCZOTKOWANA 4250,00  
**\*GF** GRAFITOWY 4900,00  
**TS** TUSCAN 4900,00  
**\*ORSP** ŻŁOTY SZCZOTKOWANY 6850,00

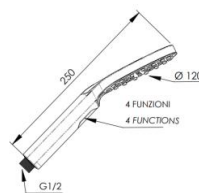

**A443MP..** RĄCZKA NATRYSKOWA **PULSANTE II**

**-DANIEL-**

**CR** CHROM 95,00  
**NO** CZARNY MAT 140,00



**89001..** BATERIA WANNOWA ŚCIENNA (KORPUS)

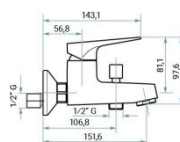

<b>CR</b>	CHROM	<b>520,00</b>
<b>*NO</b>	CZARNY MAT	<b>700,00</b>
<b>*RA</b>	MIEDŹ SZCZOTKOWANA	<b>850,00</b>
<b>*BR</b>	STARE ZŁOTO	<b>850,00</b>
<b>*TS</b>	TUSCAN	<b>1020,00</b>
<b>*OR</b>	ZŁOTY BŁYSZCZĄCY	<b>1300,00</b>



**89002..** BATERIA NATRYSKOWA ŚCIENNA (KORPUS)

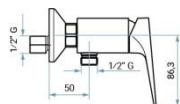

<b>CR</b>	CHROM	<b>370,00</b>
<b>*NO</b>	CZARNY MAT	<b>535,00</b>
<b>*RA</b>	MIEDŹ SZCZOTKOWANA	<b>640,00</b>
<b>*BR</b>	STARE ZŁOTO	<b>640,00</b>
<b>*TS</b>	TUSCAN	<b>790,00</b>
<b>*OR</b>	ZŁOTY BŁYSZCZĄCY	<b>980,00</b>



**89003TC..** BATERIA UMYWALKOWA STOJĄCA (BEZ KORKA)

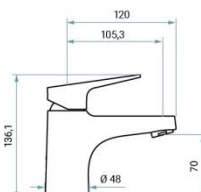

<b>CR</b>	CHROM	<b>360,00</b>
<b>*NO</b>	CZARNY MAT	<b>510,00</b>
<b>*RA</b>	MIEDŹ SZCZOTKOWANA	<b>610,00</b>
<b>*BR</b>	STARE ZŁOTO	<b>610,00</b>
<b>*TS</b>	TUSCAN	<b>750,00</b>
<b>*OR</b>	ZŁOTY BŁYSZCZĄCY	<b>920,00</b>



**89004..** BATERIA BIDETOWA STOJĄCA (BEZ KORKA)

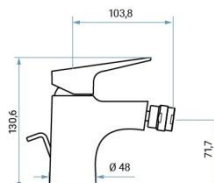

<b>CR</b>	CHROM	<b>360,00</b>
<b>*NO</b>	CZARNY MAT	<b>510,00</b>
<b>*RA</b>	MIEDŹ SZCZOTKOWANA	<b>610,00</b>
<b>*BR</b>	STARE ZŁOTO	<b>610,00</b>
<b>*TS</b>	TUSCAN	<b>750,00</b>
<b>*OR</b>	ZŁOTY BŁYSZCZĄCY	<b>920,00</b>



**89009..** BATERIA PODTYNKOWA 1-DROŻNA

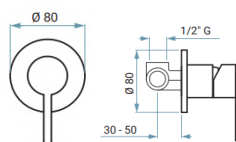

<b>CR</b>	CHROM	<b>280,00</b>
<b>*NO</b>	CZARNY MAT	<b>380,00</b>
<b>*RA</b>	MIEDŹ SZCZOTKOWANA	<b>450,00</b>
<b>*BR</b>	STARE ZŁOTO	<b>450,00</b>
<b>*TS</b>	TUSCAN	<b>530,00</b>
<b>*OR</b>	ZŁOTY BŁYSZCZĄCY	<b>680,00</b>

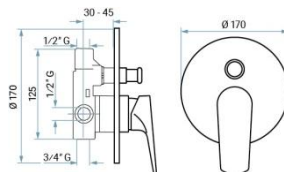

**89019..** BATERIA PODTYNKOWA 2-DROŻNA

<b>CR</b>	CHROM	<b>620,00</b>
<b>*NO</b>	CZARNY MAT	<b>830,00</b>
<b>*RA</b>	MIEDŹ SZCZOTKOWANA	<b>1000,00</b>
<b>*BR</b>	STARE ŻŁOTO	<b>1000,00</b>
<b>*TS</b>	TUSCAN	<b>1200,00</b>
<b>*OR</b>	ŻŁOTY BŁYSZCZĄCY	<b>1490,00</b>

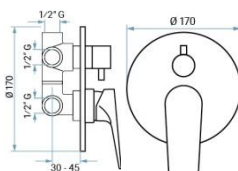

**89029..** BATERIA PODTYNKOWA 3-DROŻNA

<b>CR</b>	CHROM	<b>790,00</b>
<b>*NO</b>	CZARNY MAT	<b>1000,00</b>
<b>*RA</b>	MIEDŹ SZCZOTKOWANA	<b>1170,00</b>
<b>*BR</b>	STARE ŻŁOTO	<b>1170,00</b>
<b>*TS</b>	TUSCAN	<b>1425,00</b>
<b>*OR</b>	ŻŁOTY BŁYSZCZĄCY	<b>1680,00</b>

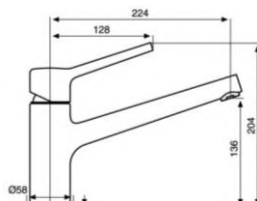

**75007..** BATERIA ZLEWOZMYWAKOWA STOJĄCA



<b>CR</b>	CHROM	<b>750,00</b>
<b>*NO</b>	CZARNY MAT	<b>1150,00</b>

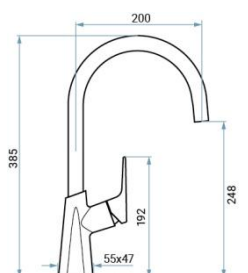

**89077..** BATERIA ZLEWOZMYWAKOWA STOJĄCA



<b>CR</b>	CHROM	<b>960,00</b>
<b>*NO</b>	CZARNY MAT	<b>1300,00</b>
<b>*RA</b>	MIEDŹ SZCZOTKOWANA	<b>1560,00</b>
<b>*BR</b>	STARE ŻŁOTO	<b>1560,00</b>
<b>*TS</b>	TUSCAN	<b>1900,00</b>
<b>*OR</b>	ŻŁOTY BŁYSZCZĄCY	<b>2400,00</b>



SKŁAD ZESTAWU:  
- ZESTAW 3W1  
- WYLEWKA ŚCIENNA L-180MM



**NIC015ZWW..** ZESTAW WANNOWY PODTYNKOWY

<b>CR</b>	CHROM	<b>1350,00</b>
<b>*NO</b>	CZARNY MAT	<b>1950,00</b>
<b>*RA</b>	MIEDŹ SZCZOTKOWANA	<b>2200,00</b>
<b>*BR</b>	STARE ŻŁOTO	<b>2200,00</b>
<b>*TS</b>	TUSCAN	<b>2600,00</b>
<b>*OR</b>	ŻŁOTY BŁYSZCZĄCY	<b>3200,00</b>



**SKŁAD ZESTAWU:**  
 - DESZCZOWNICA:  
 (INDEKS A) ZSOF074  $\varnothing 225\text{MM}$  -PAFFONI-  
 (INDEKS G) C06657-25  $\varnothing 250\text{MM}$   
 - RAMIĘ ŚCIENNE L-400MM  
 - ZESTAW 3W1

**NIC015ZSC3..** ZESTAW NATRYSKOWY PODTYNKOWY



**INDEKS A** ZSOF074  $\varnothing 225\text{mm}$

**CR** CHROM 1635,00  
**\*NO** CZARNY MAT 2460,00

**INDEKS G** C06657-25  $\varnothing 250\text{mm}$

**CR** CHROM 2300,00  
**\*NO** CZARNY MAT 3400,00  
**\*RA** MIEDŹ SZCZOTKOWANA 3750,00  
**\*BR** STARE ZŁOTO 3750,00  
**\*TS** TUSCAN 4400,00  
**\*OR** ZŁOTY BŁYSZCZĄCY 5400,00



**SKŁAD ZESTAWU:**  
 - DESZCZOWNICA:  
 (INDEKS A) ZSOF074  $\varnothing 225\text{MM}$  -PAFFONI-  
 (INDEKS G) C06657-25  $\varnothing 250\text{MM}$   
 - RAMIĘ ŚCIENNE L-400MM  
 - ZESTAW 3W1

**NIC019ZSCW3..** ZESTAW WANNOWY PODTYNKOWY



**INDEKS A** ZSOF074  $\varnothing 225\text{mm}$

**CR** CHROM 2115,00  
**\*NO** CZARNY MAT 3050,00

**INDEKS G** C06657-25  $\varnothing 250\text{mm}$

**\*CR** CHROM 2700,00  
**\*NO** CZARNY MAT 3900,00  
**\*RA** MIEDŹ SZCZOTKOWANA 4250,00  
**\*BR** STARE ZŁOTO 4250,00  
**\*TS** TUSCAN 5000,00  
**\*OR** ZŁOTY BŁYSZCZĄCY 6200,00



**EM167..** ZESTAW 3W1



**CR** CHROM 410,00  
**\*NO** CZARNY MAT 700,00  
**\*RA** MIEDŹ SZCZOTKOWANA 750,00  
**\*BR** STARE ZŁOTO 750,00  
**\*TS** TUSCAN 840,00  
**\*OR** ZŁOTY BŁYSZCZĄCY 1050,00



**77001..**

BATERIA WANNOWA ŚCIENNA (KORPUS)

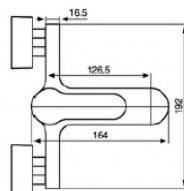

<b>CR</b>	CHROM	<b>590,00</b>
<b>*BIO</b>	BIAŁY MAT	<b>800,00</b>
<b>*NO</b>	CZARNY MAT	<b>800,00</b>
<b>*NS</b>	STAL SZCZOTKOWANA	<b>900,00</b>
<b>*RA</b>	MIEDŹ SZCZOTKOWANA	<b>900,00</b>
<b>*GF</b>	GRAFITOWY	<b>1095,00</b>



**77003..**

BATERIA UMYWALKOWA STOJĄCA (BEZ KORKA)

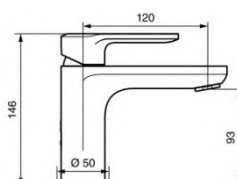

<b>CR</b>	CHROM	<b>420,00</b>
<b>*BIO</b>	BIAŁY MAT	<b>610,00</b>
<b>*NO</b>	CZARNY MAT	<b>610,00</b>
<b>*NS</b>	STAL SZCZOTKOWANA	<b>720,00</b>
<b>*RA</b>	MIEDŹ SZCZOTKOWANA	<b>720,00</b>
<b>*GF</b>	GRAFITOWY	<b>860,00</b>



**77003BIG..**

BATERIA UMYWALKOWA XL (KOREK CLICK CLACK)

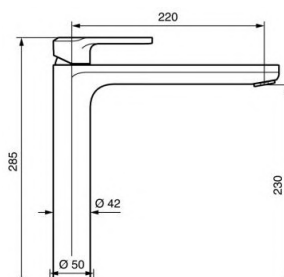

<b>CR</b>	CHROM	<b>1260,00</b>
<b>*BIO</b>	BIAŁY MAT	<b>1590,00</b>
<b>*NO</b>	CZARNY MAT	<b>1590,00</b>
<b>*NS</b>	STAL SZCZOTKOWANA	<b>1800,00</b>
<b>*RA</b>	MIEDŹ SZCZOTKOWANA	<b>1800,00</b>
<b>*GF</b>	GRAFITOWY	<b>2200,00</b>



**77004..**

BATERIA BIDETOWA STOJĄCA (KOREK AUTOMATYCZNY)

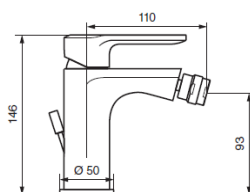

<b>CR</b>	CHROM	<b>420,00</b>
<b>*BIO</b>	BIAŁY MAT	<b>610,00</b>
<b>*NO</b>	CZARNY MAT	<b>610,00</b>
<b>*NS</b>	STAL SZCZOTKOWANA	<b>720,00</b>
<b>*RA</b>	MIEDŹ SZCZOTKOWANA	<b>720,00</b>
<b>*GF</b>	GRAFITOWY	<b>860,00</b>



**77155..** BATERIA UMYWALKOWA PODTYNKOWA

<b>CR</b>	CHROM	<b>1100,00</b>
<b>*BIO</b>	BIAŁY MAT	<b>1360,00</b>
<b>*NO</b>	CZARNY MAT	<b>1360,00</b>
<b>*NS</b>	STAL SZCZOTKOWANA	<b>1620,00</b>
<b>*RA</b>	MIEDŹ SZCZOTKOWANA	<b>1620,00</b>
<b>*GF</b>	GRAFITOWY	<b>1960,00</b>



**77009..** BATERIA PODTYNKOWA 1-DROŻNA

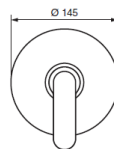

<b>CR</b>	CHROM	<b>300,00</b>
<b>*BIO</b>	BIAŁY MAT	<b>390,00</b>
<b>*NO</b>	CZARNY MAT	<b>390,00</b>
<b>*NS</b>	STAL SZCZOTKOWANA	<b>450,00</b>
<b>*RA</b>	MIEDŹ SZCZOTKOWANA	<b>450,00</b>
<b>*GF</b>	GRAFITOWY	<b>555,00</b>



**77019..** BATERIA PODTYNKOWA 2-DROŻNA

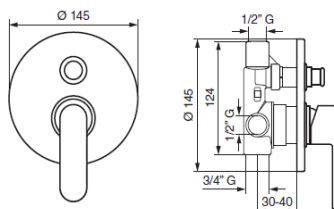

<b>CR</b>	CHROM	<b>570,00</b>
<b>*BIO</b>	BIAŁY MAT	<b>790,00</b>
<b>*NO</b>	CZARNY MAT	<b>790,00</b>
<b>*NS</b>	STAL SZCZOTKOWANA	<b>950,00</b>
<b>*RA</b>	MIEDŹ SZCZOTKOWANA	<b>950,00</b>
<b>*GF</b>	GRAFITOWY	<b>1110,00</b>



**NEF015ZSC3..** ZESTAW NATRYSKOWY PODTYNKOWY

**SKŁAD ZESTAWU:**  
 - DESZCZOWNICA:  
 (INDEKS A) ZSOF074 **Ø225MM -PAFFONI-**  
 (INDEKS E) C06657-30 **Ø300MM**  
 - RAMIĘ ŚCIENNE L-400MM  
 - ZESTAW 3W1



**INDEKS A ZSOF074 Ø225mm**

<b>CR</b>	CHROM	<b>1535,00</b>
<b>*NO</b>	CZARNY MAT	<b>2360,00</b>

**INDEKS E C06657-30 Ø300mm**

<b>CR</b>	CHROM	<b>2700,00</b>
<b>*BIO</b>	BIAŁY MAT	<b>3720,00</b>
<b>*NO</b>	CZARNY MAT	<b>3720,00</b>
<b>*NS</b>	STAL SZCZOTKOWANA	<b>4050,00</b>
<b>*RA</b>	MIEDŹ SZCZOTKOWANA	<b>4050,00</b>
<b>*GF</b>	GRAFITOWY	<b>5300,00</b>

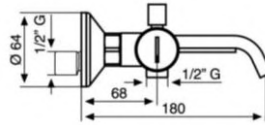

**83001..** BATERIA WANNOWA ŚCIENNA (KORPUS)

<b>*CR</b>	CHROM	<b>1530,00</b>
<b>*NO</b>	CZARNY MAT	<b>1960,00</b>
<b>*BIO</b>	BIAŁY MAT	<b>1960,00</b>

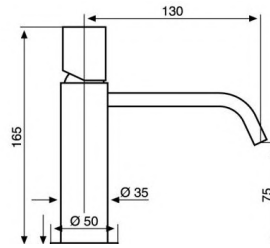

**83003..** BATERIA UMYWALKOWA STOJĄCA (KOREK CLICK CLACK)

<b>*CR</b>	CHROM	<b>990,00</b>
<b>*NO</b>	CZARNY MAT	<b>1360,00</b>
<b>*BIO</b>	BIAŁY MAT	<b>1360,00</b>

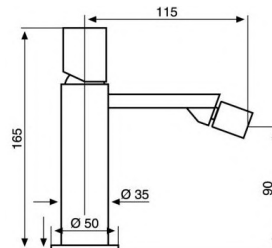

**83004..** BATERIA BIDETOWA STOJĄCA (KOREK CLICK CLACK)

<b>*CR</b>	CHROM	<b>990,00</b>
<b>*NO</b>	CZARNY MAT	<b>1360,00</b>
<b>*BIO</b>	BIAŁY MAT	<b>1360,00</b>

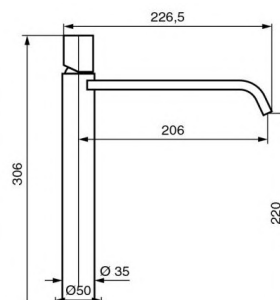

**83006..** BATERIA UMYWALKOWA WYSOKA (KOREK CLICK CLACK)

<b>*CR</b>	CHROM	<b>1480,00</b>
<b>*NO</b>	CZARNY MAT	<b>1850,00</b>
<b>*BIO</b>	BIAŁY MAT	<b>1850,00</b>



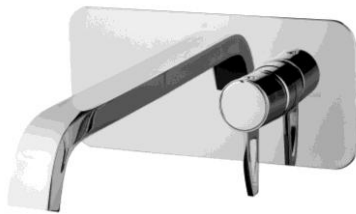

**83055LA..**

BATERIA UMYWALKOWA PODTYNKOWA

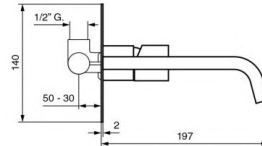

<b>*CR</b>	CHROM	<b>1460,00</b>
<b>*NO</b>	CZARNY MAT	<b>1880,00</b>
<b>*BIO</b>	BIAŁY MAT	<b>1880,00</b>



**78120..**

BATERIA WANNOWA 4-OTWOROWA

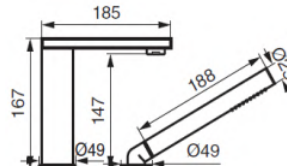

<b>*CR</b>	CHROM	<b>1930,00</b>
<b>*NO</b>	CZARNY MAT	<b>2495,00</b>
<b>*BIO</b>	BIAŁY MAT	<b>2495,00</b>



**MIN015ZWW..**

ZESTAW WANNOWY PODTYNKOWY

SKŁAD ZESTAWU:  
- ZESTAW 3w1 ZDUP094  
- WYLEWKA ŚCIENNA L-180MM



<b>*CR</b>	CHROM	<b>1600,00</b>
<b>*NO</b>	CZARNY MAT	<b>2220,00</b>
<b>*BIO</b>	BIAŁY MAT	<b>2220,00</b>



**MIN015ZSC3G..**

ZESTAW NATRYSKOWY PODTYNKOWY

SKŁAD ZESTAWU:  
- DESZCZOWNICA:  
(INDEKS G) C06657-25 **Ø250MM**  
- RAMIĘ ŚCIENNE L-400MM  
- ZESTAW 3w1



<b>*CR</b>	CHROM	<b>2400,00</b>
<b>*NO</b>	CZARNY MAT	<b>3800,00</b>
<b>*BIO</b>	BIAŁY MAT	<b>3800,00</b>



**47001LC..** BATERIA WANNOWA ŚCIENNA (KORPUS)

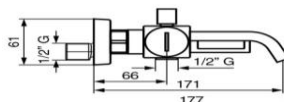

<b>*CR</b>	CHROM	<b>1700,00</b>
<b>*NO</b>	CZARNY MAT	<b>2100,00</b>
<b>*GF</b>	GRAFITOWY	<b>3100,00</b>
<b>*RA</b>	MIEDŹ SZCZOTKOWANA	<b>2510,00</b>
<b>*NS</b>	STAL SZCZOTKOWANA	<b>2510,00</b>



**47003LC..** BATERIA UMYWALKOWA STOJĄCA (KOREK CLICK CLACK)

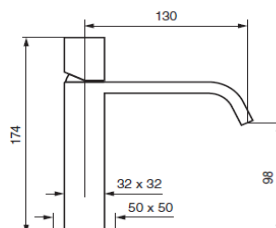

<b>*CR</b>	CHROM	<b>920,00</b>
<b>*NO</b>	CZARNY MAT	<b>1150,00</b>
<b>*GF</b>	GRAFITOWY	<b>1650,00</b>
<b>*RA</b>	MIEDŹ SZCZOTKOWANA	<b>1380,00</b>
<b>*NS</b>	STAL SZCZOTKOWANA	<b>1380,00</b>



**47004LC..** BATERIA BIDETOWA STOJĄCA (KOREK CLICK CLACK)

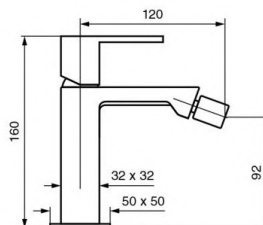

<b>*CR</b>	CHROM	<b>920,00</b>
<b>*NO</b>	CZARNY MAT	<b>1150,00</b>
<b>*GF</b>	GRAFITOWY	<b>1650,00</b>
<b>*RA</b>	MIEDŹ SZCZOTKOWANA	<b>1380,00</b>
<b>*NS</b>	STAL SZCZOTKOWANA	<b>1380,00</b>



**47006LC..** BATERIA UMYWALKOWA WYSOKA (KOREK CLICK CLACK)

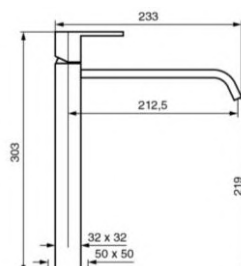

<b>*CR</b>	CHROM	<b>1490,00</b>
<b>*NO</b>	CZARNY MAT	<b>1890,00</b>
<b>*GF</b>	GRAFITOWY	<b>2680,00</b>
<b>*RA</b>	MIEDŹ SZCZOTKOWANA	<b>2200,00</b>
<b>*NS</b>	STAL SZCZOTKOWANA	<b>2200,00</b>



**47019CERLC..**

BATERIA PODTYNKOWA 2-DROŻNA

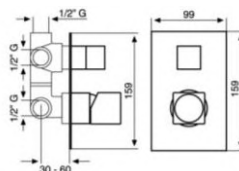

<b>*CR</b>	CHROM	<b>1105,00</b>
<b>*NO</b>	CZARNY MAT	<b>1450,00</b>
<b>*GF</b>	GRAFITOWY	<b>1950,00</b>
<b>*RA</b>	MIEDŹ SZCZOTKOWANA	<b>1700,00</b>
<b>*NS</b>	STAL SZCZOTKOWANA	<b>1700,00</b>



**47029LC..**

BATERIA PODTYNKOWA 3-DROŻNA

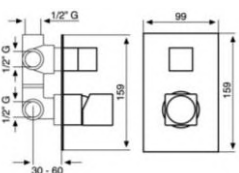

<b>*CR</b>	CHROM	<b>1105,00</b>
<b>*NO</b>	CZARNY MAT	<b>1450,00</b>
<b>*GF</b>	GRAFITOWY	<b>1950,00</b>
<b>*RA</b>	MIEDŹ SZCZOTKOWANA	<b>1700,00</b>
<b>*NS</b>	STAL SZCZOTKOWANA	<b>1700,00</b>



**47055LC..**

BATERIA UMYWALKOWA PODTYNKOWA

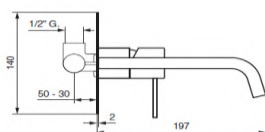

<b>*CR</b>	CHROM	<b>1395,00</b>
<b>*NO</b>	CZARNY MAT	<b>1750,00</b>
<b>*GF</b>	GRAFITOWY	<b>2500,00</b>
<b>*RA</b>	MIEDŹ SZCZOTKOWANA	<b>2050,00</b>
<b>*NS</b>	STAL SZCZOTKOWANA	<b>2050,00</b>



**47120LC..**

BATERIA WANNOWA 4-OTWOROWA

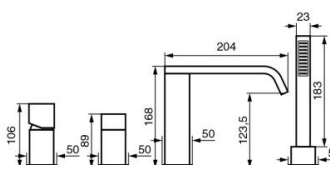

<b>*CR</b>	CHROM	<b>3020,00</b>
<b>*NO</b>	CZARNY MAT	<b>3790,00</b>
<b>*GF</b>	GRAFITOWY	<b>5490,00</b>
<b>*RA</b>	MIEDŹ SZCZOTKOWANA	<b>4520,00</b>
<b>*NS</b>	STAL SZCZOTKOWANA	<b>4520,00</b>



**SIR015ZWW..**

ZESTAW WANNOWY PODTYNKOWY

**SKŁAD ZESTAWU:**  
- ZESTAW 3w1 ZDUP095  
- WYLEWKA ŚCIENNA SK4704



<b>*CR</b>	CHROM	<b>2150,00</b>
<b>*NO</b>	CZARNY MAT	<b>3000,00</b>
<b>*GF</b>	GRAFITOWY	<b>4200,00</b>
<b>*RA</b>	MIEDŹ SZCZOTKOWANA	<b>3400,00</b>
<b>*NS</b>	STAL SZCZOTKOWANA	<b>3400,00</b>



**SKŁAD ZESTAWU:**  
 - DESZCZOWNICA:  
 (INDEKS G) C06658-25 250x250MM  
 (INDEKS F) SNK250 250x250MM, SLIM -AP-  
 - RAMIĘ ŚCIENNE L-400MM  
 - ZESTAW 3W1 156OT



**INDEKS G C06658-25 250x250mm**  
**\*CR** CHROM 3000,00  
**\*NO** CZARNY MAT 4500,00  
**\*GF** GRAFITOWY 5900,00  
**\*RA** MIEDŹ SZCZOTKOWANA 4900,00  
**\*NS** STAL SZCZOTKOWANA 4900,00

**SIR015ZSC3..** ZESTAW NATRYSKOWY PODTYNKOWY

**INDEKS F C06658-25 250x250mm**  
**\*CR** CHROM 2430,00

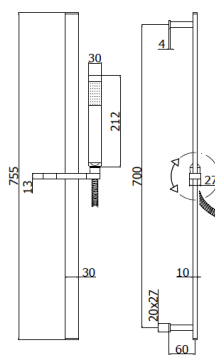

**INDEKS ZSAL145**  
**CR** CHROM 780,00  
**NO** CZARNY MAT 1300,00

**ZSAL145CR..** ZESTAW NATRYSKOWY METALOWY CITY (CHROM)  
**C02651..** ZESTAW NATRYSKOWY METALOWY CITY

**INDEKS C02651**  
**\*GF** GRAFITOWY 2400,00  
**\*RA** MIEDŹ SZCZOTKOWANA 2200,00  
**\*NS** STAL SZCZOTKOWANA 2200,00

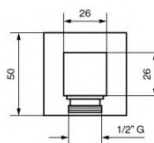

**C06909..** PRZYŁĄCZE KĄTOWE METALOWE

**\*CR** CHROM 150,00  
**\*NO** CZARNY MAT 270,00  
**\*GF** GRAFITOWY 360,00  
**\*RA** MIEDŹ SZCZOTKOWANA 320,00  
**\*NS** STAL SZCZOTKOWANA 320,00

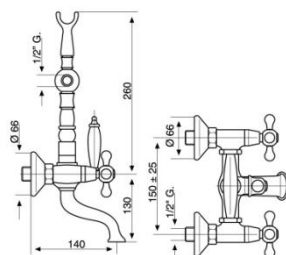

**12611..** BATERIA WANNOWA ŚCIENNA (KOMPLETNA)

<b>*CR</b>	CHROM	<b>1400,00</b>
<b>*BR</b>	STARE ZŁOTO	<b>2100,00</b>
<b>*RA</b>	MIEDŹ SZCZOTKOWANA	<b>2100,00</b>
<b>*OR</b>	ZŁOTY BŁYSZCZĄCY	<b>3200,00</b>



**1261118..** BATERIA WANNOWA WOLNOSTOJĄCA (KOMPLETNA)

<b>*CR</b>	CHROM	<b>4200,00</b>
<b>*BR</b>	STARE ZŁOTO	<b>7500,00</b>
<b>*RA</b>	MIEDŹ SZCZOTKOWANA	<b>7500,00</b>
<b>*OR</b>	ZŁOTY BŁYSZCZĄCY	<b>11500,00</b>

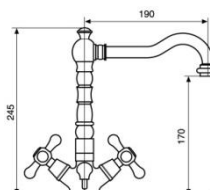

**12613..** BATERIA UMYWALKOWA STOJĄCA (KOREK AUTOMATYCZNY)

<b>*CR</b>	CHROM	<b>820,00</b>
<b>*BR</b>	STARE ZŁOTO	<b>1300,00</b>
<b>*RA</b>	MIEDŹ SZCZOTKOWANA	<b>1300,00</b>
<b>*OR</b>	ZŁOTY BŁYSZCZĄCY	<b>2000,00</b>

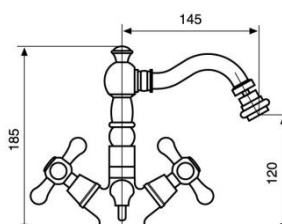

**12614..** BATERIA BIDETOWA STOJĄCA (KOREK AUTOMATYCZNY)

<b>*CR</b>	CHROM	<b>820,00</b>
<b>*BR</b>	STARE ZŁOTO	<b>1300,00</b>
<b>*RA</b>	MIEDŹ SZCZOTKOWANA	<b>1300,00</b>
<b>*OR</b>	ZŁOTY BŁYSZCZĄCY	<b>2000,00</b>



**12055..**

BATERIA UMYWALKOWA PODTYNKOWA

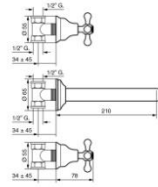

<b>*CR</b>	CHROM	<b>820,00</b>
<b>*BR</b>	STARE ZŁOTO	<b>1300,00</b>
<b>*RA</b>	MIEDŹ SZCZOTKOWANA	<b>1300,00</b>
<b>*OR</b>	ZŁOTY BŁYSZCZĄCY	<b>1900,00</b>



**12643..**

BATERIA UMYWALKOWA 3-OTWOROWA

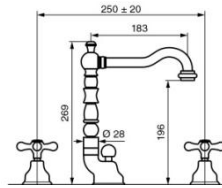

<b>*CR</b>	CHROM	<b>1300,00</b>
<b>*BR</b>	STARE ZŁOTO	<b>2050,00</b>
<b>*RA</b>	MIEDŹ SZCZOTKOWANA	<b>2050,00</b>
<b>*OR</b>	ZŁOTY BŁYSZCZĄCY	<b>3100,00</b>



**DEC010ZWW..**

ZESTAW WANNOWY PODTYNKOWY

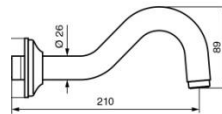

<b>*CR</b>	CHROM	<b>1600,00</b>
<b>*BR</b>	STARE ZŁOTO	<b>2850,00</b>
<b>*RA</b>	MIEDŹ SZCZOTKOWANA	<b>2850,00</b>
<b>*OR</b>	ZŁOTY BŁYSZCZĄCY	<b>3900,00</b>



**DEC010ZSCF..**

ZESTAW NATRYSKOWY PODTYNKOWY

**SKŁAD ZESTAWU:**

- DESZCZOWNICA:
- (INDEKS F) C00655-205MM -EMMEVI-
- RAMIĘ ŚCIENNE C00684 L-325MM -EMMEVI-
- PRZEŁĄCZNIK 2-DROŻNY 121019 -EMMEVI-
- ZESTAW 3W1 157 -EMMEVI-



<b>*CR</b>	CHROM	<b>2500,00</b>
<b>*BR</b>	STARE ZŁOTO	<b>4000,00</b>
<b>*RA</b>	MIEDŹ SZCZOTKOWANA	<b>4000,00</b>
<b>*OR</b>	ZŁOTY BŁYSZCZĄCY	<b>5700,00</b>

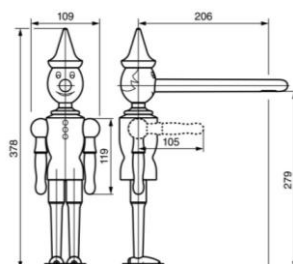
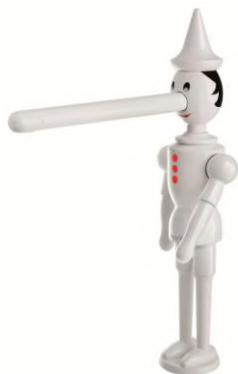

**1883BC..** BATERIA UMYWALKOWA STOJĄCA (KOREK CLICK CLACK)  
**1887BC..** BATERIA ZLEWOZMYWAKOWA STOJĄCA

**INDEKS 1883**  
**\*BC** BIAŁY **3390,00**

**INDEKS 1887**  
**\*BC** BIAŁY **3300,00**

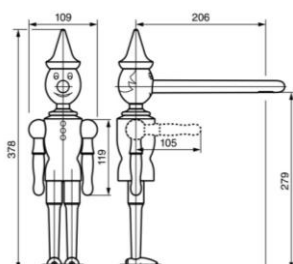

**1883CC..** BATERIA UMYWALKOWA STOJĄCA (KOREK CLICK CLACK)  
**1887CC..** BATERIA ZLEWOZMYWAKOWA STOJĄCA

**INDEKS 1883**  
**CC** KOLOROWY **3735,00**

**INDEKS 1887**  
**CC** KOLOROWY **3645,00**

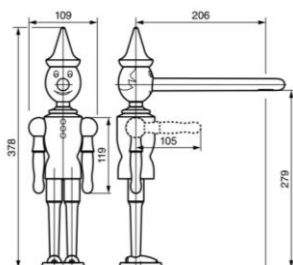

**1883CR..** BATERIA UMYWALKOWA STOJĄCA (KOREK CLICK CLACK)  
**1887CR..** BATERIA ZLEWOZMYWAKOWA STOJĄCA

**INDEKS 1883**  
**\*CR** CHROM **3290,00**

**INDEKS 1887**  
**\*CR** CHROM **3200,00**

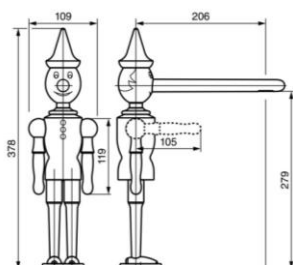

**1883LC..** BATERIA UMYWALKOWA STOJĄCA (KOREK CLICK CLACK)  
**1887LC..** BATERIA ZLEWOZMYWAKOWA STOJĄCA

**INDEKS 1883**  
**\*LC** DREWNIANY **3940,00**

**INDEKS 1887**  
**\*LC** DREWNIANY **3850,00**



**ZDUP112..**

BATERIA BIDETOWA PODTYNKOWA **VIOLA**

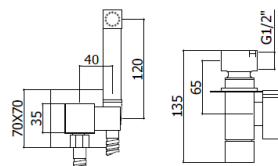

**-PAFFONI-**



**CR**  
**NO**

CHROM  
CZARNY MAT

**600,00**  
**800,00**



**22704..**

BATERIA BIDETOWA PODTYNKOWA **SANY**

**ZDUP110..**

BATERIA BIDETOWA PODTYNKOWA **SANY**

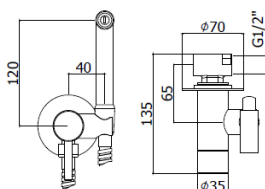

**-AP-**

**-PAFFONI-**



**INDEKS 22704**

**CR**

CHROM

**520,00**

**INDEKS ZDUP110**

**CR**

CHROM

**520,00**

**BO**

BIAŁY MAT

**800,00**

**NO**

CZARNY MAT

**800,00**

**ST**

STAL SZCZOTKOWANA

**950,00**

**BR**

STARE ZŁOTO

**1050,00**

**HG**

ZŁOTY BŁYSZCZĄCY

**1200,00**

**\*HGSP**

ZŁOTY SZCZOTKOWANY

**1350,00**



**SK642..**

BATERIA BIDETOWA PODTYNKOWA **SKYLINE**

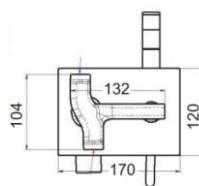

**-DANIEL-**



**CR**

CHROM

**1500,00**

**\*FIN.A**

**2400,00**

**\*FIN.B**

**3000,00**



**TX6454DC..**

BATERIA BIDETOWA PODTYNKOWA

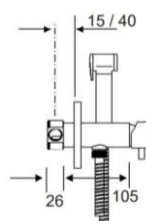

**-DANIEL-**



**\*CR**

CHROM

**850,00**

**.64**

MIEDŹ SZCZOTKOWANA

**1210,00**

**.DP**

ZŁOTY SZCZOTKOWANY

**1510,00**

**\*.FZ**

GUNMETAL

**1510,00**

**\*FIN.A**

**1210,00**

**\*FIN.B**

**1510,00**





**RT645..**

BATERIA BIDETOWA PODTYNKOWA **RETRO**

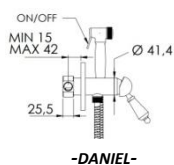

**-DANIEL-**



**\*CR**  
**\*FIN.A**  
**\*FIN.B**

CHROM

**1150,00**  
**1840,00**  
**2300,00**



**LES010...**

BATERIA BIDETOWA PODTYNKOWA

- PODŁĄCZENIE PODTYNKOWE Z UCHWYTEM ZSUP032
- RĄCZKA BIDETKA 1010DC
- WĄŻ NATRYSKOWY
- (INDEKS **M**) L-120CM METALOWY
- (INDEKS **S**) L-120CM SILVER



**P1M**  
**P1S**

CHROM  
CHROM

**705,00**  
**710,00**



**DR602...**

BATERIA BIDETOWA PODTYNKOWA

- PODŁĄCZENIE PODTYNKOWE Z UCHWYTEM ZSUP031
- RĄCZKA BIDETKA 1010DC
- WĄŻ NATRYSKOWY
- (INDEKS **M**) L-120CM METALOWY
- (INDEKS **S**) L-120CM SILVER



**M1M**  
**M1S**

CHROM  
CHROM

**720,00**  
**725,00**



**SK010P2M..**

BATERIA BIDETOWA PODTYNKOWA

- PODŁĄCZENIE PODTYNKOWE Z UCHWYTEM ZSUP031
- RĄCZKA BIDETKA 22701
- WĄŻ NATRYSKOWY L-120CM METALOWY



**CR**

CHROM

**610,00**



**WR602P2M..**

BATERIA BIDETOWA PODTYNKOWA

- PODŁĄCZENIE PODTYNKOWE Z UCHWYTEM ZSUP031
- RĄCZKA BIDETKA 22701
- WĄŻ NATRYSKOWY L-120CM METALOWY



**CR**

CHROM

**580,00**

# BIDETKI



**66430..**

BATERIA BIDETOWA PODTYNKOWA

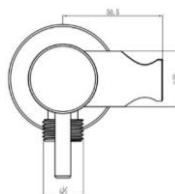

**CR**

CHROM

**390,00**



**66435..**

BATERIA BIDETOWA PODTYNKOWA



**CR**

CHROM

**420,00**



**1010DC..**

RĄCZKA BIDETKA METALOWA

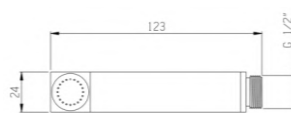

**CR**

CHROM

**185,00**

**\*FIN.A**

**330,00**

**\*FIN.B**

**440,00**



**22701..**

RĄCZKA BIDETKA METALOWA

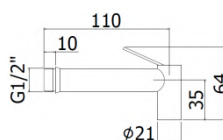

**CR**

CHROM

**125,00**

**BO**

BIAŁY MAT

**195,00**

**NO**

CZARNY MAT

**195,00**

**ST**

STAL SZCZOTKOWANA

**220,00**

**\*BR**

STARE ZŁOTO

**275,00**

**HG**

ZŁOTY BEYSZCZĄCY

**390,00**

**\*HGSP**

ZŁOTY SZCZOTKOWANY

**400,00**



**1004DC..**

RĄCZKA BIDETKA METALOWA

**CR**

CHROM

**125,00**

**\*FIN.A**

**200,00**

**\*FIN.B**

**250,00**



**ZDUP109..**

BATERIA BIDETOWA PODTYNKOWA

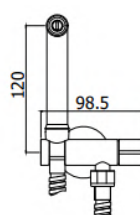

**CR**

CHROM

**290,00**



# BATERIE KUCHENNE

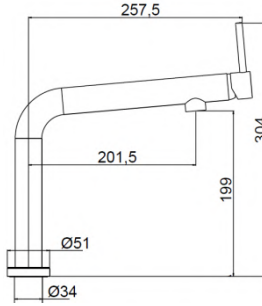

**78CR579WS..** BATERIA ZLEWOZMYWAKOWA STOJĄCA



**CR** CHROM

**1050,00**

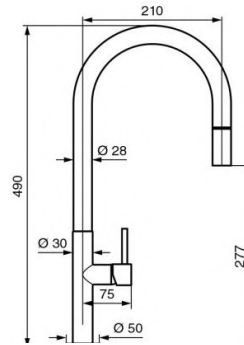

**78067P..** BATERIA ZLEWOZMYWAKOWA Z WYCIĄGANĄ WYLEWKĄ

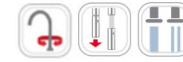

<b>CR</b>	CHROM	<b>1300,00</b>
<b>BIO</b>	BIAŁY MAT	<b>1700,00</b>
<b>NO</b>	CZARNY MAT	<b>1700,00</b>
<b>*RA</b>	MIEDŹ SZCZOTKOWANA	<b>2200,00</b>
<b>*BR</b>	STARE ZŁOTO	<b>2200,00</b>
<b>*GF</b>	GRAFITOWY	<b>2900,00</b>
<b>OR</b>	ZŁOTY BŁYSZCZĄCY	<b>3100,00</b>

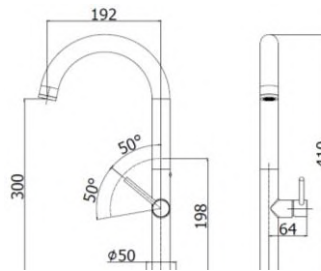

**CH180..** BATERIA ZLEWOZMYWAKOWA STOJĄCA



**CR** CHROM

**850,00**

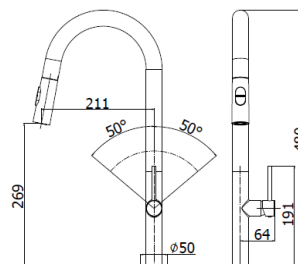

**CH185..** BATERIA ZLEWOZMYWAKOWA STOJĄCA Z WĘŻEM OPERACYJNYM



**CR** CHROM

**1000,00**

# BATERIE KUCHENNE

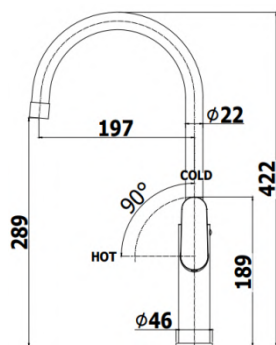

CA180..

BATERIA ZLEWOZMYWAKOWA STOJĄCA



CR

CHROM

710,00

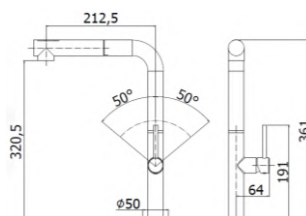

CH985..

BATERIA ZLEWOZMYWAKOWA STOJĄCA Z WĘZEM OPERACYJNYM



CR

CHROM

920,00

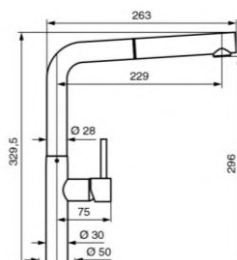

78066P..

BATERIA ZLEWOZMYWAKOWA Z WYCIĄGANĄ WYLEWKĄ



\*CR

CHROM

1100,00

\*BIO

BIAŁY MAT

1400,00

NO

CZARNY MAT

1400,00

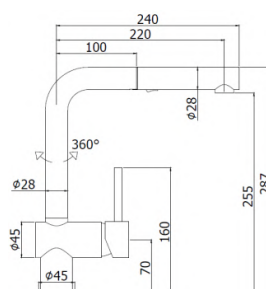

LIG285..

BATERIA ZLEWOZMYWAKOWA STOJĄCA Z WĘZEM OPERACYJNYM



CR

CHROM

900,00

BO

BIAŁY MAT

1170,00

NO

CZARNY MAT

1170,00

ST

STAL SZCZOTKOWANA

1350,00

MG

GRAFITOWY

1290,00

RMSP

MIEDŹ SZCZOTKOWANA

1800,00

HG

ZŁOTY BŁYSZCZĄCY

2200,00

HGSP

ZŁOTY SZCZOTKOWANY

2380,00

# BATERIE KUCHENNE

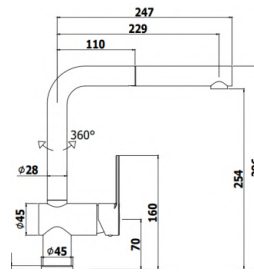

CR CHROM  
NO CZARNY MAT

**RIN/WS185..** BATERIA ZLEWOZMYWAKOWA STOJĄCA 1-STRUMIENIOWA

**690,00**  
**900,00**

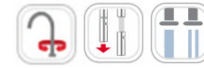
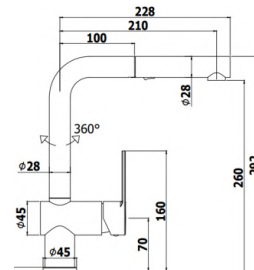

CR CHROM  
NO CZARNY MAT

**RIN/WS285..** BATERIA ZLEWOZMYWAKOWA STOJĄCA 2-STRUMIENIOWA

**740,00**  
**960,00**

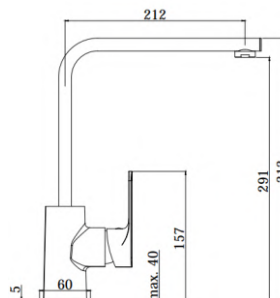

CR CHROM

**SY180..** BATERIA ZLEWOZMYWAKOWA STOJĄCA

**875,00**

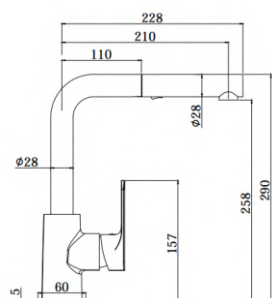

CR CHROM

**SY285..** BATERIA ZLEWOZMYWAKOWA STOJĄCA

**820,00**

# BATERIE KUCHENNE

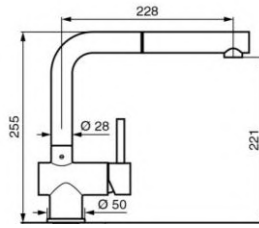

**45044INES..**

BATERIA ZLEWOZMYWAKOWA STOJĄCA INOX

**INOX** INOX – STAL SZCZOTKOWANA **1200,00**

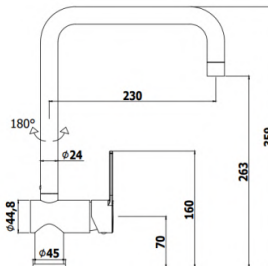

**RIN/WS980..**

BATERIA ZLEWOZMYWAKOWA STOJĄCA

**CR** CHROM  
**NO** CZARNY MAT

**660,00**  
**860,00**

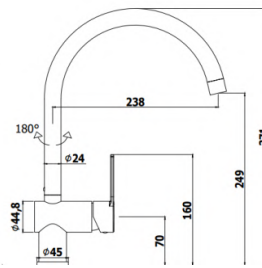

**RIN/WS180..**

BATERIA ZLEWOZMYWAKOWA STOJĄCA

**CR** CHROM  
**NO** CZARNY MAT

**650,00**  
**880,00**

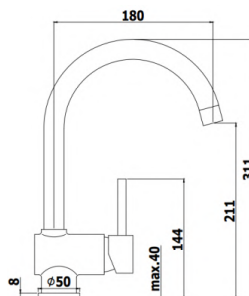

**SK180..**

BATERIA ZLEWOZMYWAKOWA STOJĄCA

**CR** CHROM  
**\*ST** STAL SZCZOTKOWANA

**540,00**  
**800,00**

# BATERIE KUCHENNE



**SK185..**

BATERIA ZLEWOZMYWAKOWA STOJĄCA Z WĘŻEM OPERACYJNYM

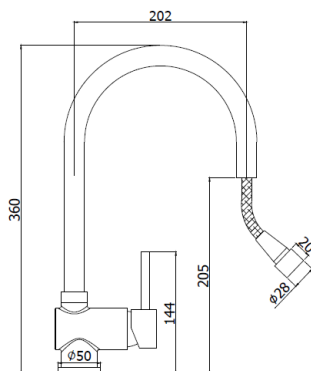

<b>CR</b>	CHROM	<b>840,00</b>
<b>ST</b>	STAL SZCZOTKOWANA	<b>1300,00</b>



**LIG280..**

BATERIA ZLEWOZMYWAKOWA STOJĄCA

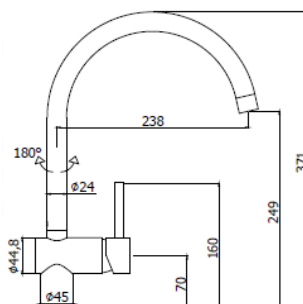

<b>CR</b>	CHROM	<b>740,00</b>
<b>*BO</b>	BIAŁY MAT	<b>955,00</b>
<b>NO</b>	CZARNY MAT	<b>955,00</b>
<b>*ST</b>	STAL SZCZOTKOWANA	<b>1100,00</b>
<b>MG</b>	GRAFITOWY	<b>1050,00</b>
<b>RMSP</b>	MIEDŹ SZCZOTKOWANA	<b>1500,00</b>
<b>HG</b>	ZŁOTY BŁYSZCZĄCY	<b>1800,00</b>
<b>*HGSP</b>	ZŁOTY SZCZOTKOWANY	<b>1950,00</b>



**SK176..**

BATERIA ZLEWOZMYWAKOWA STOJĄCA Z WĘŻEM OPERACYJNYM

**SK177..**

BATERIA ZLEWOZMYWAKOWA STOJĄCA Z WĘŻEM OPERACYJNYM

**SK178..**

BATERIA ZLEWOZMYWAKOWA STOJĄCA Z WĘŻEM OPERACYJNYM

**SK179..**

BATERIA ZLEWOZMYWAKOWA STOJĄCA Z WĘŻEM OPERACYJNYM

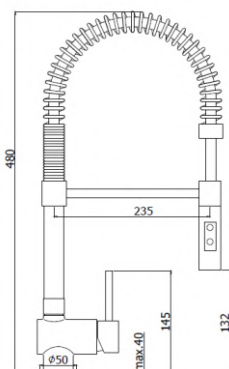

176 - 177 - 178 - 179



<b>CR</b>	CHROM	<b>1190,00</b>
<b>ST</b>	STAL SZCZOTKOWANA	<b>1800,00</b>

# BATERIE KUCHENNE

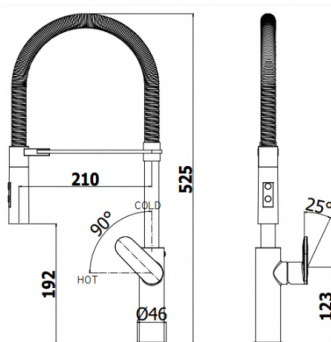

**CA179..**

BATERIA ZLEWOZMYWAKOWA STOJĄCA Z WĘŻEM OPERACYJNYM



**CR**  
**CRNO**

CHROM/SREBRNY  
CHROM/CZARNY

**1480,00**  
**1505,00**

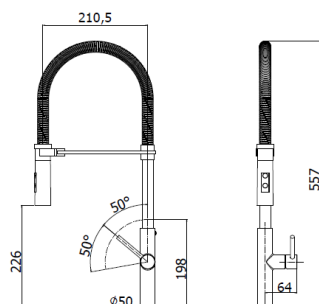

**CH179CR..**

BATERIA ZLEWOZMYWAKOWA STOJĄCA Z WĘŻEM OPERACYJNYM (SREBRNYM)

**CH179CRNO..**

BATERIA ZLEWOZMYWAKOWA STOJĄCA Z WĘŻEM OPERACYJNYM (CZARNYM)



**CR**  
**CRNO**

INDEKS CH179CR  
CHROM

**1450,00**

INDEKS CH179CRNO

CHROM

**1500,00**

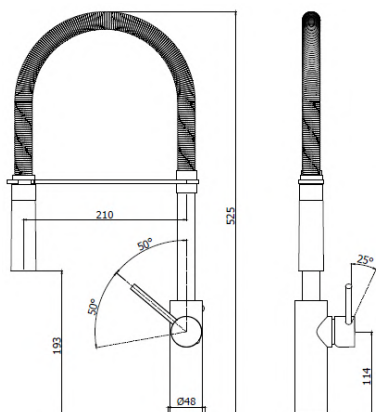

**LIG179..**

BATERIA ZLEWOZMYWAKOWA STOJĄCA ZE SREBRNYM WĘŻEM

**LIG179..NO**

BATERIA ZLEWOZMYWAKOWA STOJĄCA Z CZARNYM WĘŻEM



**CR**

INDEKS LIG179

CHROM

**1320,00**

INDEKS LIG179..NO

**CR**

CHROM

**1390,00**

**NO**

CZARNY MAT

**1800,00**

**ST**

STAL SZCZOTKOWANA

**2080,00**

**MG**

GRAFITOWY

**1890,00**

**RMSP**

MIEDŹ SZCZOTKOWANA

**2800,00**

**HG**

ZŁOTY BŁYSZCZĄCY

**3400,00**

**HGSP**

ZŁOTY SZCZOTKOWANY

**3750,00**



# BATERIE KUCHENNE

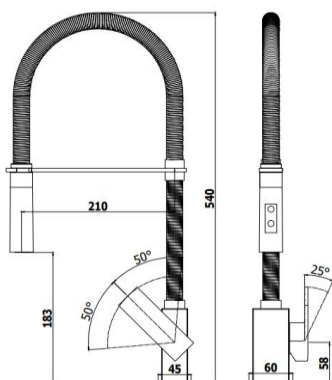

**EL/EF179..**

BATERIA ZLEWOZMYWAKOWA STOJĄCA Z WĘŻEM OPERACYJNYM

**CR**

INDEKS **EL179** LUB **EF179**

CHROM

**1630,00**

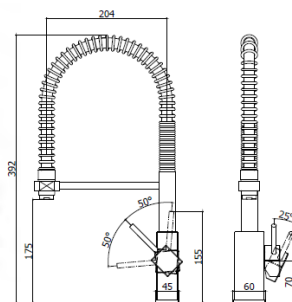

**LEA176..**

BATERIA ZLEWOZMYWAKOWA STOJĄCA Z WĘŻEM OPERACYJNYM

**CR**  
**\*ST**

CHROM

STAL SZCZOTKOWANA

**1250,00**

**2050,00**

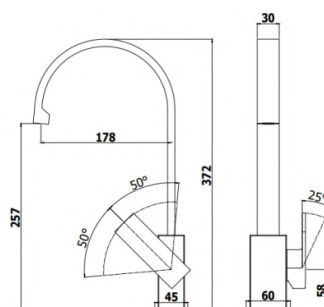

**EL/EF880..**

BATERIA ZLEWOZMYWAKOWA STOJĄCA

**CR**

CHROM

**1390,00**

# BATERIE KUCHENNE

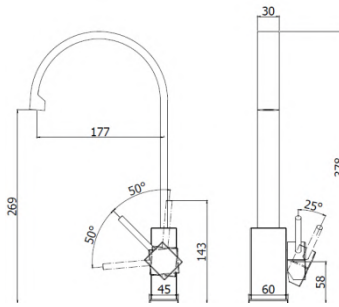

**LEA880..**

BATERIA ZLEWOZMYWAKOWA STOJĄCA



**CR**  
**\*ST**

CHROM  
STAL SZCZOTKOWANA

**1450,00**  
**2400,00**

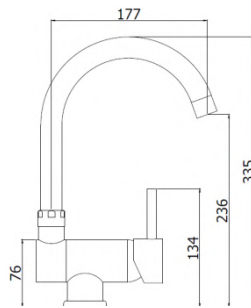

**SK189..**

BATERIA ZLEWOZMYWAKOWA PODOKIENNA



**CR**  
**\*ST**

CHROM  
STAL SZCZOTKOWANA

**760,00**  
**1150,00**

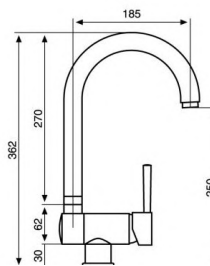

**45335..**

BATERIA ZLEWOZMYWAKOWA PODOKIENNA



**\*CR**  
**\*BIO**  
**NO**  
**\*RA**  
**\*BR**  
**\*GF**  
**\*OR**

CHROM  
BIAŁY MAT  
CZARNY MAT  
MIEDŹ SZCZOTKOWANA  
STARE ZŁOTO  
GRAFITOWY  
ZŁOTY BŁYSZCZĄCY

**880,00**  
**1180,00**  
**1180,00**  
**1400,00**  
**1400,00**  
**1700,00**  
**2080,00**

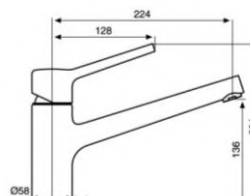

**75007..**

BATERIA ZLEWOZMYWAKOWA STOJĄCA



**CR**  
**\*BIO**  
**\*NO**

CHROM  
BIAŁY MAT  
CZARNY MAT

**750,00**  
**1150,00**  
**1150,00**

# BATERIE KUCHENNE

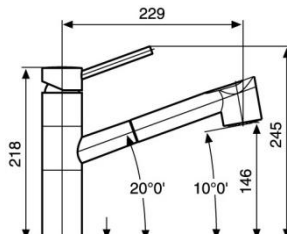

**45065..**

BATERIA ZLEWOZMYWAKOWA STOJĄCA



**\*CR**

CHROM

**1200,00**

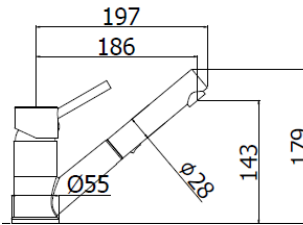

**BI183..**

BATERIA ZLEWOZMYWAKOWA STOJĄCA Z WYCIĄGANYM WĘŻEM

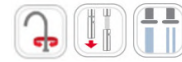

**CR**

CHROM

**620,00**

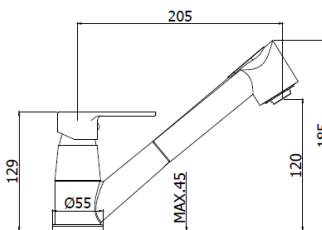

**RED183..**

BATERIA ZLEWOZMYWAKOWA STOJĄCA Z WĘŻEM OPERACYJNYM

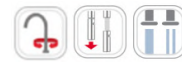

**CR**

CHROM

**555,00**

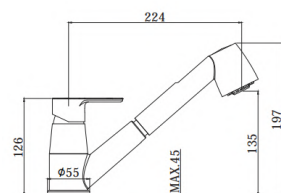

**BLU183..**

BATERIA ZLEWOZMYWAKOWA STOJĄCA Z WĘŻEM OPERACYJNYM



**CR**

CHROM

**590,00**

# BATERIE KUCHENNE

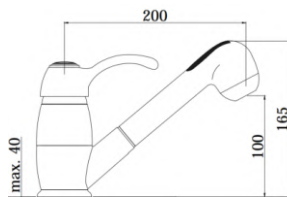

*CR	CHROM	680,00
*CO	CHROM/ZŁOTO	830,00
*BR	STARE ZŁOTO	1230,00
*RM	MIEDŹ SZCZOTKOWANA	1230,00

**FA183..** BATERIA ZLEWOZMYWAKOWA STOJĄCA Z WĘŻEM OPERACYJNYM

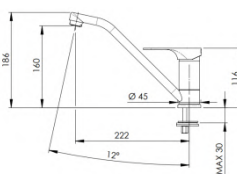

CR	CHROM	340,00
*FIN.A		540,00
*FIN.B		680,00

**OM629..** BATERIA ZLEWOZMYWAKOWA STOJĄCA

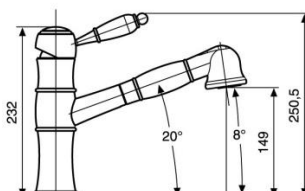

CR	CHROM	1500,00
*CRSWNE	CHROM+SWAROVSKI	1900,00
BR	STARE ZŁOTO	2310,00
*RA	MIEDŹ SZCZOTKOWANA	2310,00
*OR	ZŁOTY BŁYSZCZĄCY	3550,00

**40065..** BATERIA ZLEWOZMYWAKOWA STOJĄCA Z WĘŻEM OPERACYJNYM

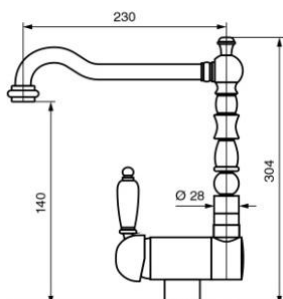

CR	CHROM	1100,00
*CRSWNE	CHROM+SWAROVSKI	1450,00
BR	STARE ZŁOTO	1750,00
*RA	MIEDŹ SZCZOTKOWANA	1750,00
*OR	ZŁOTY BŁYSZCZĄCY	2700,00

**40335..** BATERIA ZLEWOZMYWAKOWA PODOKIENNA

# BATERIE KUCHENNE



**FME181..**

BATERIA ZLEWOZMYWAKOWA STOJĄCA

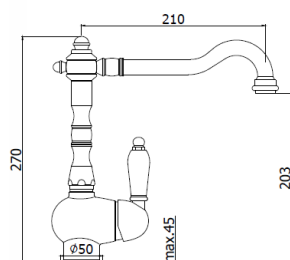

<b>CR</b>	CHROM	<b>1080,00</b>
<b>BR</b>	STARE ZŁOTO	<b>1910,00</b>
<b>*RM</b>	MIEDŹ SZCZOTKOWANA	<b>1910,00</b>



**IRV180..**

BATERIA ZLEWOZMYWAKOWA STOJĄCA

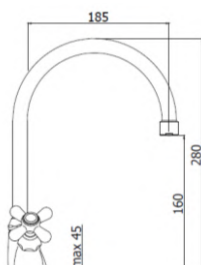

<b>CR</b>	CHROM	<b>430,00</b>
<b>*CO</b>	CHROM/ZŁOTO	<b>520,00</b>
<b>*GF</b>	ZŁOTO	<b>950,00</b>
<b>*BR</b>	STARE ZŁOTO	<b>790,00</b>



**PR2169..**

BATERIA ZLEWOZMYWAKOWA STOJĄCA

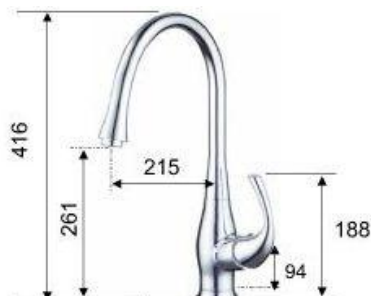

<b>CR</b>	CHROM	<b>900,00</b>
-----------	-------	---------------



**12645..**

Bateria zlewozmywakowa ścienna

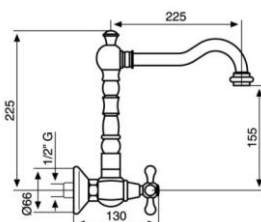

<b>*CR</b>	CHROM	<b>800,00</b>
<b>*BR</b>	STARE ZŁOTO	<b>1200,00</b>
<b>*OR</b>	ZŁOTY BŁYSZCZĄCY	<b>1950,00</b>
<b>*RA</b>	MIEDŹ SZCZOTKOWANA	<b>1200,00</b>

# BATERIE KUCHENNE



**SK609..**

BATERIA ZLEWOZMYWAKOWA ŚCIENNA L-20cm



**CR**

CHROM

**1420,00**



**RO161..**

BATERIA ZLEWOZMYWAKOWA ŚCIENNA

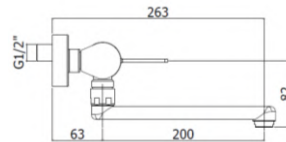

**CR**

CHROM

**750,00**

**\*ST**

STAL SZCZOTKOWANA

**1200,00**



**RIN161..**

BATERIA ZLEWOZMYWAKOWA ŚCIENNA

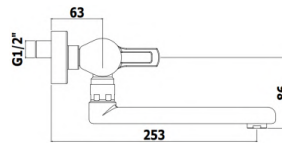

**CR**

CHROM

**750,00**

**NO**

CZARNY MAT

**950,00**



**OM633..**

BATERIA ZLEWOZMYWAKOWA ŚCIENNA



**CR**

CHROM

**570,00**

**\*FIN.A**

**950,00**

**\*FIN.B**

**1140,00**



**OM614TC..**

BATERIA ZLEWOZMYWAKOWA 45° Z RUCHOMĄ WYLEWKĄ

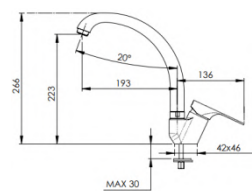

OM614TC



**CR**

CHROM

**380,00**

**\*FIN.A**

**560,00**

**\*FIN.B**

**700,00**

# BATERIE KUCHENNE



**QTV180..**

BATERIA ZLEWOZMYWAKOWA STOJĄCA

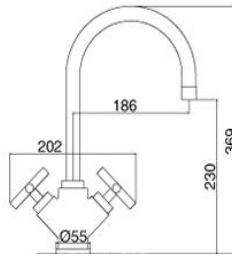

**CR**

CHROM

**980,00**



**QR84..**

BATERIA ZLEWOZMYWAKOWA STOJĄCA

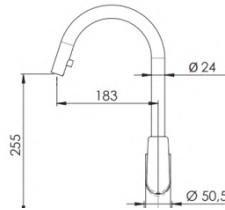

**\*CR**

CHROM

**1100,00**

**\*FZ**

GUNMETAL

**2200,00**

**\*FIN.A**

**1800,00**

**\*FIN.B**

**2200,00**



**SK184..**

BATERIA ZLEWOZMYWAKOWA STOJĄCA (Z PODŁĄCZENIEM DO ZMYWARKI)

**SK190..**

BATERIA ZLEWOZMYWAKOWA STOJĄCA (Z PODŁĄCZENIEM DO WODY FILTROWANEJ)

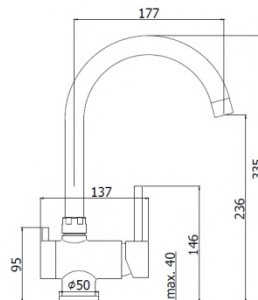

**CR**

CHROM

**800,00**

**\*ST**

STAL SZCZOTKOWANA

**1300,00**



**RIN/WS184..**

BATERIA ZLEWOZMYWAKOWA STOJĄCA Z PODŁĄCZENIEM DO ZMYWARKI

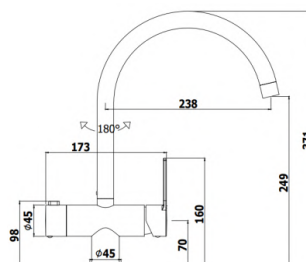

**CR**

CHROM

**900,00**

**\*NO**

CZARNY MAT

**1200,00**

# BATERIE KUCHENNE

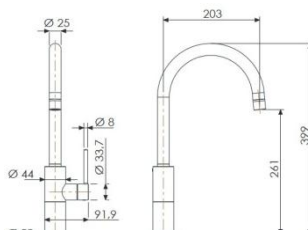

**SSTX618..**

BATERIA ZLEWOZMYWAKOWA STOJĄCA

\*INOX

**2750,00**

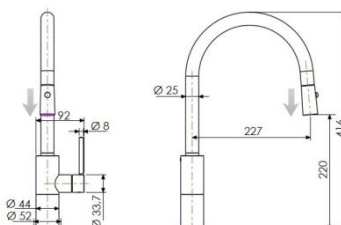

\*INOX

\*SS1

\*SS2

\*SS3



PVD - GUNMETAL

PVD - ZŁOTO SZCZOTK.

PVD - MIEDŹ SZCZOTK.

**3380,00**

**7450,00**

**7450,00**

**7450,00**

**SSTX684DJ..**

BATERIA ZLEWOZMYWAKOWA STOJĄCA



INOX

**45127IN..**

BATERIA ZLEWOZMYWAKOWA 3-STRUMIENIOWA

**1100,00**



# BATERIE WOLNOSTOJĄCE



**45030..**

BATERIA WANNOWA WOLNOSTOJĄCA (KOMPLETNA)



**CR**

CHROM

**2790,00**

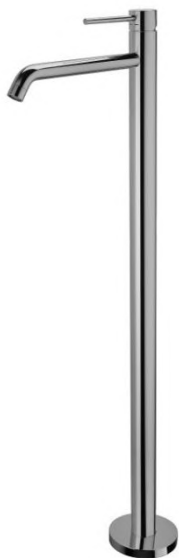

**LIG031..**

BATERIA UMYWALKOWA WOLNOSTOJĄCA (KOMPLETNA)

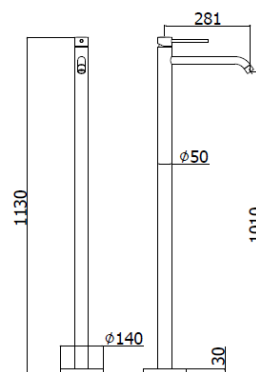

**CR**

CHROM

**6000,00**

**NO**

CZARNY MAT

**7400,00**



**LIG032..**

BATERIA WANNOWA WOLNOSTOJĄCA (KOMPLETNA)

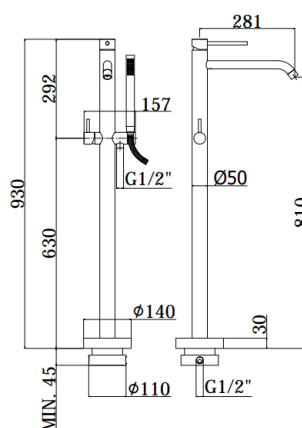

**CR**

CHROM

**6400,00**

**\*BO**

BIAŁY MAT

**8000,00**

**NO**

CZARNY MAT

**8000,00**

**ST**

STAL SZCZOTKOWANA

**9100,00**

**\*MG**

GRAFITOWY

**8000,00**

**\*RMSP**

MIEDŹ SZCZOTKOWANA

**11700,00**

**\*HG**

ZŁOTY BŁYSZCZĄCY

**15000,00**

**\*HGSP**

ZŁOTY SZCZOTKOWANY

**15500,00**

# BATERIE WOLNOSTOJĄCE

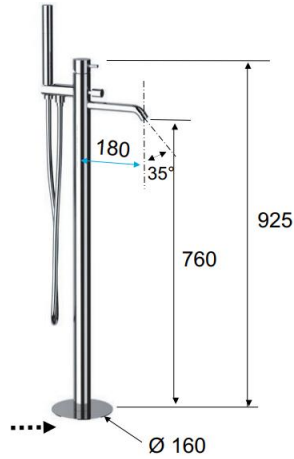

**TX678..**

BATERIA WANNOWA WOLNOSTOJĄCA (KOMPLETNA)

<b>*CR</b>	CHROM	<b>4620,00</b>
<b>*.64</b>	MIEDŹ SZCZOTKOWANA	<b>7400,00</b>
<b>*.DP</b>	ZŁOTY SZCZOTKOWANY	<b>9250,00</b>
<b>*.FZ</b>	GUNMETAL	<b>9250,00</b>
<b>*FIN.A</b>		<b>7400,00</b>
<b>*FIN.B</b>		<b>9250,00</b>

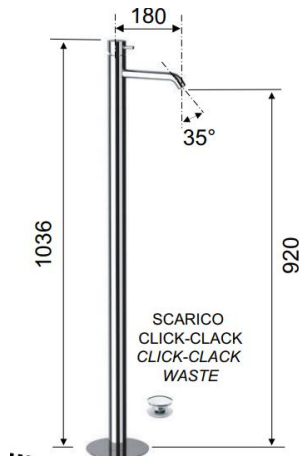
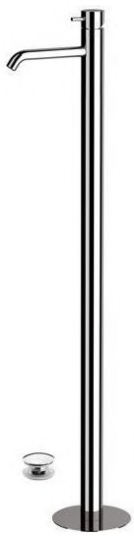

**TX688..**

BATERIA UMYWALKOWA WOLNOSTOJĄCA (KOMPLETNA)

<b>*CR</b>	CHROM	<b>4000,00</b>
<b>*.64</b>	MIEDŹ SZCZOTKOWANA	<b>6400,00</b>
<b>*.DP</b>	ZŁOTY SZCZOTKOWANY	<b>8000,00</b>
<b>*.FZ</b>	GUNMETAL	<b>8000,00</b>
<b>*FIN.A</b>		<b>6400,00</b>
<b>*FIN.B</b>		<b>8000,00</b>

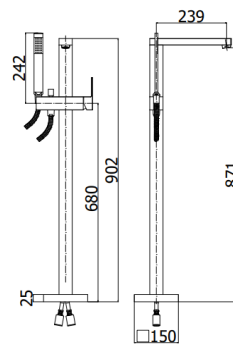

**EL/EF033..**

BATERIA WANNOWA WOLNOSTOJĄCA (KOMPLETNA)

<b>*CR</b>	CHROM	<b>7700,00</b>
------------	-------	----------------

# BATERIE WOLNOSTOJĄCE



**SK678..**

BATERIA WANNOWA WOLNOSTOJĄCA (KOMPLETNA)

<b>CR</b>	CHROM	<b>6000,00</b>
<b>*FIN.A</b>		<b>9600,00</b>
<b>*FIN.B</b>		<b>12000,00</b>



**SK688..**

BATERIA UMYWALKOWA WOLNOSTOJĄCA (KOMPLETNA)

<b>CR</b>	CHROM	<b>5300,00</b>
<b>*FIN.A</b>		<b>8500,00</b>
<b>*FIN.B</b>		<b>10600,00</b>



**RT4102XL..**

BATERIA WANNOWA WOLNOSTOJĄCA (KOMPLETNA)

<b>INDEKS RT – UCHWYT Z ŻYWICY</b>		
<b>CR</b>	CHROM	<b>3000,00</b>
<b>*FIN.A</b>		<b>4500,00</b>
<b>*FIN.B</b>		<b>5500,00</b>

<b>INDEKS RY – UCHWYT SWAROVSKI</b>		
<b>*CR</b>	CHROM	<b>3600,00</b>
<b>*FIN.A</b>		<b>5800,00</b>
<b>*FIN.B</b>		<b>7200,00</b>

# BATERIE TERMOSTATYCZNE

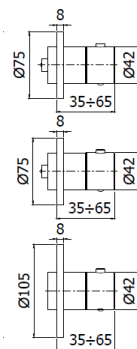

<b>CR</b>	CHROM	<b>3840,00</b>
<b>BO</b>	BIAŁY MAT	<b>4100,00</b>
<b>NO</b>	CZARNY MAT	<b>4100,00</b>
<b>ST</b>	STAL SZCZOTKOWANA	<b>4300,00</b>
<b>HG</b>	ZŁOTY	<b>5100,00</b>
<b>HGSP</b>	ZŁOTY SZCZOTKOWANY	<b>5400,00</b>

**MDE018..** BATERIA PODTYNKOWA **TERMOSTAT 2-DROŻNA (MDBOX018)**

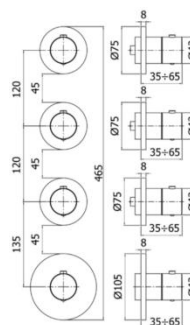

<b>CR</b>	CHROM	<b>4800,00</b>
<b>BO</b>	BIAŁY MAT	<b>5100,00</b>
<b>NO</b>	CZARNY MAT	<b>5100,00</b>
<b>ST</b>	STAL SZCZOTKOWANA	<b>5400,00</b>
<b>HG</b>	ZŁOTY	<b>6400,00</b>
<b>HGSP</b>	ZŁOTY SZCZOTKOWANY	<b>6700,00</b>

**MDE019..** BATERIA PODTYNKOWA **TERMOSTAT 3-DROŻNA (MDBOX019)**

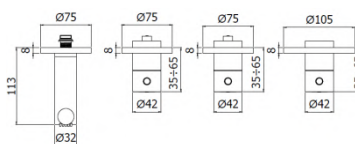

<b>CR</b>	CHROM	<b>5000,00</b>
<b>BO</b>	BIAŁY MAT	<b>5400,00</b>
<b>NO</b>	CZARNY MAT	<b>5400,00</b>
<b>ST</b>	STAL SZCZOTKOWANA	<b>5200,00</b>
<b>HG</b>	ZŁOTY	<b>7100,00</b>
<b>HGSP</b>	ZŁOTY SZCZOTKOWANY	<b>7500,00</b>

**MDE000..** BATERIA PODTYNKOWA **TERMOSTAT 2-DROŻNA (MDBOX000)**

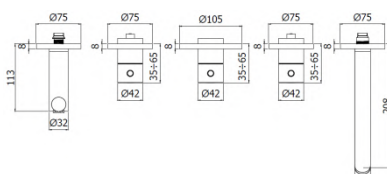
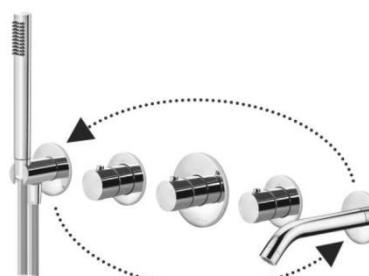

<b>CR</b>	CHROM	<b>6000,00</b>
<b>BO</b>	BIAŁY MAT	<b>6600,00</b>
<b>NO</b>	CZARNY MAT	<b>6600,00</b>
<b>ST</b>	STAL SZCZOTKOWANA	<b>7000,00</b>
<b>HG</b>	ZŁOTY	<b>8000,00</b>
<b>HGSP</b>	ZŁOTY SZCZOTKOWANY	<b>8400,00</b>

**MDE001..** BATERIA WANNOWA PODTYNKOWA **TERMOSTAT L-208MM (MDBOX001)**

# BATERIE TERMOSTATYCZNE

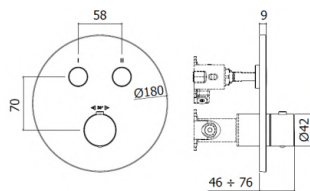

- CPT013..** BATERIA PODTYNKOWA **TERMOSTAT** 1-DROŻNA (KOMPLETNA Z **CPBOX**)  
**CPT018..** BATERIA PODTYNKOWA **TERMOSTAT** 2-DROŻNA (KOMPLETNA Z **CPBOX**)  
**CPT019..** BATERIA PODTYNKOWA **TERMOSTAT** 3-DROŻNA (KOMPLETNA Z **CPBOX**)

<b>CR</b>	CHROM	<b>2800,00</b>
<b>BO</b>	BIAŁY MAT	<b>3700,00</b>
<b>NO</b>	CZARNY MAT	<b>3700,00</b>
<b>ST</b>	STAL SZCZOTKOWANA	<b>3900,00</b>
<b>HG</b>	ZŁOTY BŁYSZCZĄCY	<b>4600,00</b>
<b>HGSP</b>	ZŁOTY SZCZOTKOWANY	<b>5100,00</b>

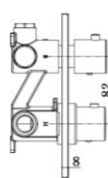
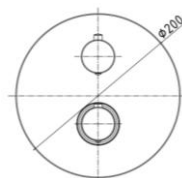

- LIQ013..** BATERIA PODTYNKOWA **TERMOSTAT** 1-DROŻNA  
**LIQ018..** BATERIA PODTYNKOWA **TERMOSTAT** 2-DROŻNA  
**LIQ019..** BATERIA PODTYNKOWA **TERMOSTAT** 3-DROŻNA

<b>CR</b>	CHROM	<b>1420,00</b>
<b>*BO</b>	BIAŁY MAT	<b>2000,00</b>
<b>NO</b>	CZARNY MAT	<b>2000,00</b>
<b>ST</b>	STAL SZCZOTKOWANA	<b>2200,00</b>
<b>MG</b>	GRAFITOWY	<b>2000,00</b>
<b>RMSP</b>	MIEDŹ SZCZOTKOWANA	<b>2750,00</b>
<b>*HG</b>	ZŁOTY BŁYSZCZĄCY	<b>3400,00</b>
<b>*HGSP</b>	ZŁOTY SZCZOTKOWANY	<b>3700,00</b>

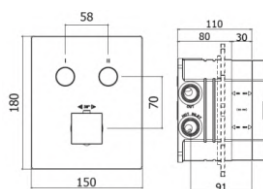

- CPT513..** BATERIA PODTYNKOWA **TERMOSTAT** 1-DROŻNA (KOMPLETNA Z **CPBOX**)  
**CPT518..** BATERIA PODTYNKOWA **TERMOSTAT** 2-DROŻNA (KOMPLETNA Z **CPBOX**)  
**CPT519..** BATERIA PODTYNKOWA **TERMOSTAT** 3-DROŻNA (KOMPLETNA Z **CPBOX**)

<b>CR</b>	CHROM	<b>2800,00</b>
<b>BO</b>	BIAŁY MAT	<b>3700,00</b>
<b>NO</b>	CZARNY MAT	<b>3700,00</b>
<b>ST</b>	STAL SZCZOTKOWANA	<b>3900,00</b>

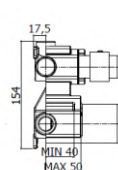
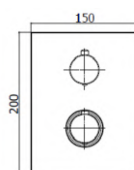

- LIQ513..** BATERIA PODTYNKOWA **TERMOSTAT** 1-DROŻNA  
**LIQ518..** BATERIA PODTYNKOWA **TERMOSTAT** 2-DROŻNA  
**LIQ519..** BATERIA PODTYNKOWA **TERMOSTAT** 3-DROŻNA

<b>CR</b>	CHROM	<b>1600,00</b>
<b>*BO</b>	BIAŁY MAT	<b>2200,00</b>
<b>NO</b>	CZARNY MAT	<b>2200,00</b>
<b>*ST</b>	STAL SZCZOTKOWANA	<b>2550,00</b>
<b>*HG</b>	ZŁOTY	<b>4200,00</b>
<b>*HGSP</b>	ZŁOTY SZCZOTKOWANY	<b>4600,00</b>

# BATERIE TERMOSTATYCZNE

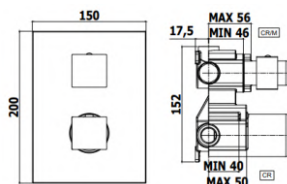

- LEQ513..** BATERIA PODTYNKOWA **TERMOSTAT** 1-DROŻNA  
**LEQ518..** BATERIA PODTYNKOWA **TERMOSTAT** 2-DROŻNA  
**LEQ519..** BATERIA PODTYNKOWA **TERMOSTAT** 3-DROŻNA

<b>CR</b>	CHROM	<b>1950,00</b>
<b>NO</b>	CZARNY MAT	<b>2800,00</b>
<b>*ST</b>	STAL SZCZOTKOWANA	<b>3200,00</b>

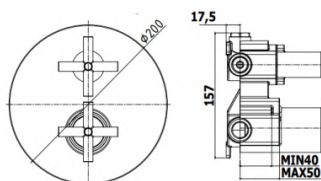

- QTV018 ..** BATERIA PODTYNKOWA 2-DROŻNA **TERMOSTAT**  
**QTV019..** BATERIA PODTYNKOWA 3-DROŻNA **TERMOSTAT**

<b>CR</b>	CHROM	<b>1750,00</b>
-----------	-------	----------------

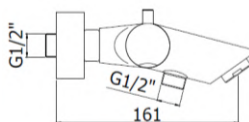

- LIQ023..** BATERIA WANNOWA ŚCIENNA **TERMOSTAT** (KOMPLETNA)

## INDEKS LIQ022

<b>CR</b>	CHROM	<b>1300,00</b>
<b>*BO</b>	BIAŁY MAT	<b>1600,00</b>
<b>NO</b>	CZARNY MAT	<b>1600,00</b>
<b>*ST</b>	STAL SZCZOTKOWANA	<b>1850,00</b>
<b>*MG</b>	GRAFITOWY	<b>1600,00</b>
<b>*RMSP</b>	MIEDŹ SZCZOTKOWANA	<b>2200,00</b>
<b>*HG</b>	ZŁOTY BŁYSZCZĄCY	<b>2700,00</b>
<b>*HGSP</b>	ZŁOTY SZCZOTKOWANY	<b>2950,00</b>

## INDEKS LIQ023

<b>CR</b>	CHROM	<b>1600,00</b>
<b>*BO</b>	BIAŁY MAT	<b>2000,00</b>
<b>NO</b>	CZARNY MAT	<b>2000,00</b>
<b>*ST</b>	STAL SZCZOTKOWANA	<b>2400,00</b>
<b>*MG</b>	GRAFITOWY	<b>2000,00</b>
<b>*RMSP</b>	MIEDŹ SZCZOTKOWANA	<b>2800,00</b>
<b>*HG</b>	ZŁOTY BŁYSZCZĄCY	<b>3400,00</b>
<b>*HGSP</b>	ZŁOTY SZCZOTKOWANY	<b>3850,00</b>

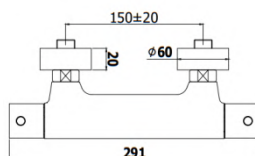

- LIQ168..** BATERIA NATRYSKOWA ŚCIENNA **TERMOSTAT** (KORPUS)

<b>CR</b>	CHROM	<b>930,00</b>
<b>*BO</b>	BIAŁY MAT	<b>1220,00</b>
<b>NO</b>	CZARNY MAT	<b>1220,00</b>
<b>*ST</b>	STAL SZCZOTKOWANA	<b>1400,00</b>
<b>*MG</b>	GRAFITOWY	<b>1220,00</b>
<b>*RMSP</b>	MIEDŹ SZCZOTKOWANA	<b>1700,00</b>
<b>*HG</b>	ZŁOTY BŁYSZCZĄCY	<b>2050,00</b>
<b>*HGSP</b>	ZŁOTY SZCZOTKOWANY	<b>2200,00</b>

# BATERIE TERMOSTATYCZNE

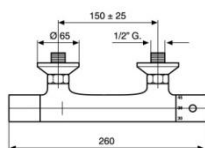

**9402..**

BATERIA NATRYSKOWA ŚCIENNA **TERMOSTAT** (KORPUS)

**CR**

CHROM

**530,00**

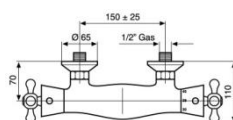

**12300..**

BATERIA NATRYSKOWA ŚCIENNA **TERMOSTAT** (KORPUS)

**CR**

CHROM

**1200,00**

**BR**

STARE ZŁOTO

**1800,00**

**\*RA**

MIEDŹ SZCZOTKOWANA

**1800,00**

**\*OR**

ZŁOTY BŁYSZCZĄCY

**2760,00**

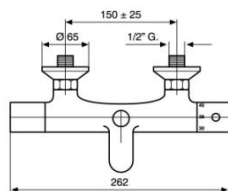

**9401..**

BATERIA WANNOWA ŚCIENNA **TERMOSTAT** (KORPUS)

**CR**

CHROM

**700,00**

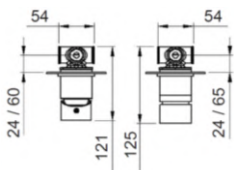

**TXT625..**

BATERIA PODTYNKOWA 2-DROŻNA **TERMOSTAT**

**\*CR**

CHROM

**1800,00**

**.64**

MIEDŹ SZCZOTKOWANA

**2850,00**

**.DP**

ZŁOTY SZCZOTKOWANY

**3550,00**

**\*.FZ**

GUNMETAL

**3550,00**

**\*FIN.A**

**2850,00**

**\*FIN.B**

**3550,00**

# CHROMOTERAPIA



DESZCZOWNICA:  
- A579JCM50 50x50cm (CHROMOTERAPIA)  
- ZESTAW 3W1 ZDUP095

**LES018ZES01-LED..**

ZESTAW NATRYSKOWY Z DESZCZOWNICĄ SUFITOWĄ

CR

CHROM

**9800,00**



DESZCZOWNICA:  
- A579JCM50 50x50cm(CHROMOTERAPIA)  
- ZESTAW 3W1 ZDUP095  
- 4 DYSZE BOCZNE C06641

**LES019ZES03-LED..**

ZESTAW NATRYSKOWY Z DESZCZOWNICĄ SUFITOWĄ

CR

CHROM

**11500,00**



# CHROMOTERAPIA



DESZCZOWNICA:  
- A579JCM50 50x50cm (CHROMOTERAPIA)  
- ZESTAW 3W1 ZDUP095

**LEQ518ZES01-LED..**

ZESTAW NATRYSKOWY Z DESZCZOWNICĄ SUFITOWĄ

CR

CHROM

10500,00



DESZCZOWNICA:  
- A579JCM50 50x50cm  
(CHROMOTERAPIA)  
- ZESTAW 3W1 ZDUP095  
- 4 DYSZE BOCZNE C06641

**LEQ519ZES03-LED..**

ZESTAW NATRYSKOWY Z DESZCZOWNICĄ SUFITOWĄ

CR

CHROM

12000,00

# AP SYSTEM



DESZCZOWNICA:  
- ZSOF301 50x50cm  
- ZESTAW 3W1 ZDUP095

**LES018ZES01..** ZESTAW NATRYSKOWY Z DESZCZOWNICĄ SUFITOWĄ

CR

CHROM

4650,00



DESZCZOWNICA:  
- A579SFCM50C 50x50cm  
- ZESTAW 3W1 ZDUP095

**LES019ZES02..** ZESTAW NATRYSKOWY Z DESZCZOWNICĄ SUFITOWĄ Z KASKADĄ

CR

CHROM

6900,00



DESZCZOWNICA:  
- ZSOF301 50x50cm  
- ZESTAW 3W1 ZDUP095  
- 4 DYSZE BOCZNE C06641

**LES019ZES03..** ZESTAW NATRYSKOWY Z DESZCZOWNICĄ SUFITOWĄ Z KASKADĄ

CR

CHROM

6500,00

# AP SYSTEM



DESZCZOWNICA:  
- ZSOF301 50x50cm  
- ZESTAW 3W1 ZDUP095

**LEQ518ZES01..** ZESTAW NATRYSKOWY **TERMOSTAT** Z DESZCZOWNICĄ SUFITOWĄ **CR** CHROM **5600,00**



DESZCZOWNICA:  
- A579SFCM50C 50x50cm  
- ZESTAW 3W1 ZDUP095

**LEQ519ZES02..** ZESTAW NATRYSKOWY **TERMOSTAT** Z DESZCZOWNICĄ SUFITOWĄ Z KASKADĄ **CR** CHROM **7800,00**



DESZCZOWNICA:  
- ZSOF301 50x50cm  
- ZESTAW 3W1 ZDUP095  
- 4 DYSZE BOCZNE C06641

**LEQ519ZES03..** ZESTAW NATRYSKOWY **TERMOSTAT** Z DESZCZOWNICĄ SUFITOWĄ Z KASKADĄ **CR** CHROM **7500,00**

# AP SYSTEM



DESZCZOWNICA:  
- ZSOF303 ø40CM  
- ZESTAW 3W1 ZDUP094

**SK018ZES01..**

ZESTAW NATRYSKOWY Z DESZCZOWNICĄ SUFITOWĄ

CR

CHROM

3900,00

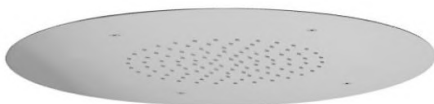

DESZCZOWNICA:  
- ZSOF303 ø40CM  
- ZESTAW 3W1 ZDUP094

**LIQ018ZES01..**

ZESTAW NATRYSKOWY Z DESZCZOWNICĄ SUFITOWĄ

CR

CHROM

4300,00



DESZCZOWNICA:  
- ZSOF303 ø40CM  
- ZESTAW 3W1 ZDUP094  
- 4 DYSZE BOCZNE C06640

**LIQ019ZES03..**

ZESTAW NATRYSKOWY Z DESZCZOWNICĄ SUFITOWĄ

CR

CHROM

5800,00

# KOLUMNY NATYNKOWE

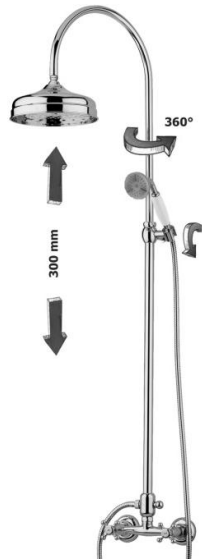

**ZCOL000..** KOLUMNA NATRYSKOWA **BELINDA**

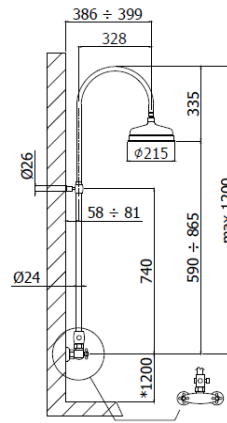

**CR** CHROM 3100,00  
**BR** STARE ZŁOTO 5600,00

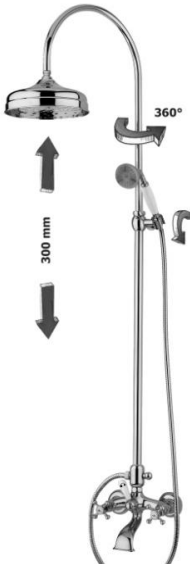

**ZCOL000-022..** KOLUMNA WANNOWA **BELINDA**

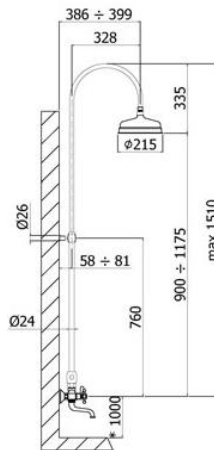

**\*CR** CHROM 3800,00  
**\*BR** STARE ZŁOTO 6800,00

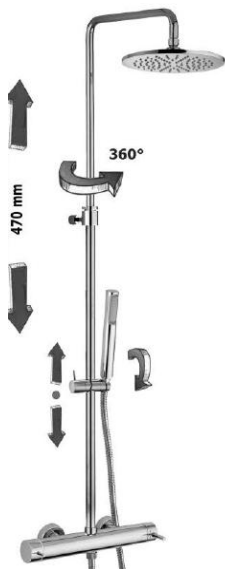

**ZCOL599..** KOLUMNA NATRYSKOWA **MINI MASTER NEW**

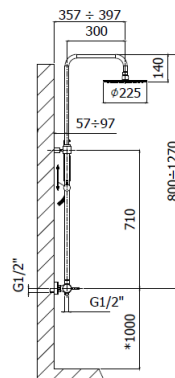

**CR** CHROM 1900,00

# KOLUMNY NATYNKOWE



ZCOL601..

KOLUMNA NATRYSKOWA **MASTER PLUS**

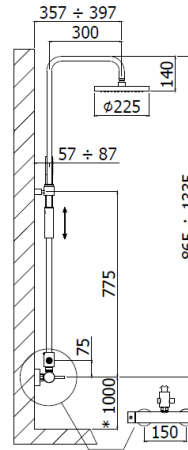

CR

CHROM

2200,00



ZCOL603..

KOLUMNA NATRYSKOWA **EASY PLUS**

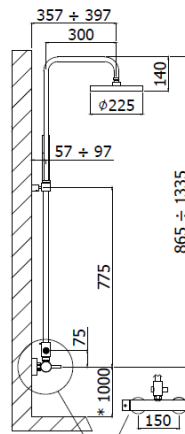

CR

CHROM

2400,00



ZCOL607..

KOLUMNA NATRYSKOWA

**LEVEL PLUS**

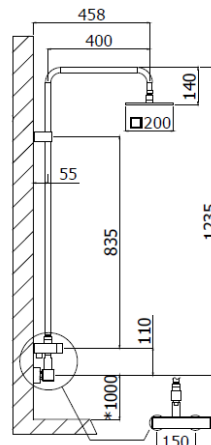

CR

CHROM

3000,00

# KOLUMNY NATYNKOWE

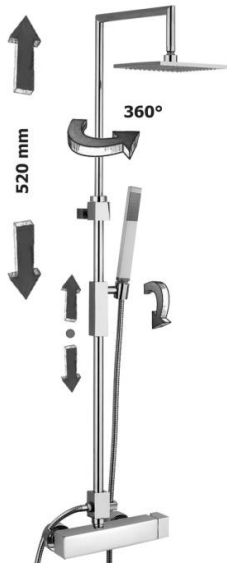

**ZCOL620..**

KOLUMNA NATRYSKOWA **SYNCR0**

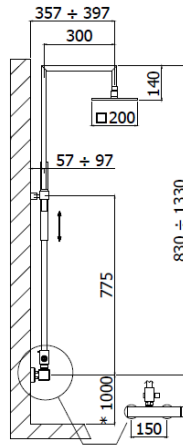

**CR**

CHROM

**2850,00**



**ZCOL632..**

KOLUMNA WANNOWA **BLU**

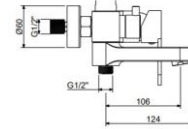
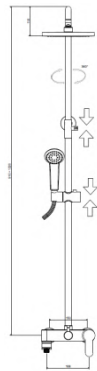

**CR**

CHROM

**1700,00**

**NO**

CZARNY MAT

**2600,00**



**ZCOL643..**

KOLUMNA NATRYSKOWA TERMOSTATYCZNA **LIGHT COLD**

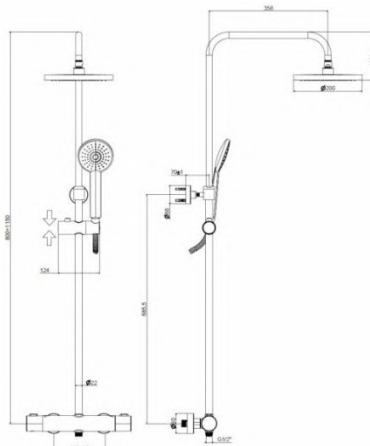

**CR**

CHROM

**1460,00**

# KOLUMNY NATYNKOWE



**ZCOL644..**

KOLUMNA NATRYSKOWA **MICRO**



**CR**

CHROM

**1300,00**

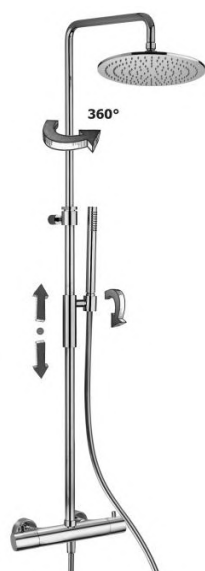

**ZCOL646..**

KOLUMNA NATRYSKOWA TERMOSTATYCZNA

ø**225MM**

**ZCOL646K..**

KOLUMNA NATRYSKOWA TERMOSTATYCZNA

ø**300MM**

**ZCOL646X..**

KOLUMNA NATRYSKOWA TERMOSTATYCZNA

ø**250MM**

-AP-

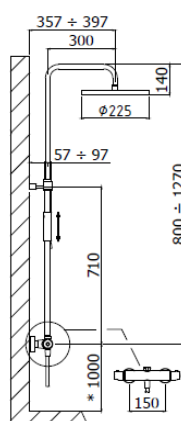

**INDEKS ZCOL646**

**CR**

CHROM

**2200,00**

**ST**

STAL SZCZOTKOWANA **4400,00**

**INDEKS ZCOL646K**

**CR**

CHROM

**2500,00**

**ST**

STAL SZCZOTKOWANA **5100,00**

**RMSP**

MIEDŹ SZCZOTKOWANA **5700,00**

**\*HG**

ZŁOTY BŁYSZCZĄCY **5300,00**

**\*HGSP**

ZŁOTY SZCZOTKOWANY **5700,00**

**INDEKS ZCOL646X**

**CR**

CHROM

**2100,00**

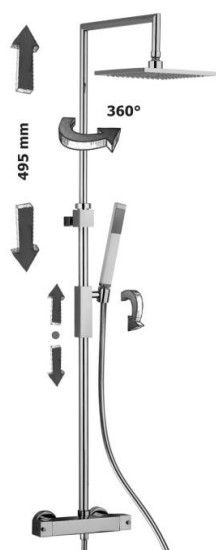

**ZCOL655CRX..**

KOLUMNA NATRYSKOWA TERMOSTATYCZNA **250x250MM SLIM \*AP\***

**ZCOL655..**

KOLUMNA NATRYSKOWA TERMOSTATYCZNA **200x200MM**

**ZCOL655K..**

KOLUMNA NATRYSKOWA TERMOSTATYCZNA **300x300MM**

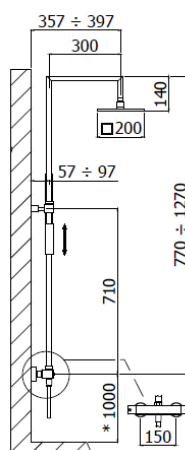

**INDEKS ZCOL655CRX**

**CR**

CHROM

**3150,00**

**INDEKS ZCOL655**

**CR**

CHROM

**3200,00**

**\*ST**

STAL SZCZOTKOWANA **6000,00**

**INDEKS ZCOL655K**

**CR**

CHROM

**3500,00**



# KOLUMNY NATYNKOWE



**ZCOL665..**

KOLUMNA NATRYSKOWA TERMOSTATYCZNA **CITY**

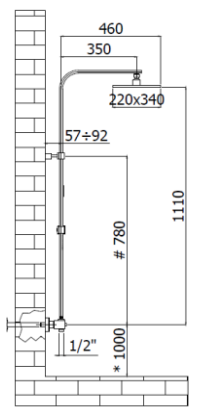

**CR**

CHROM

**4800,00**



**ZCOL668..**

KOLUMNA NATRYSKOWA TERMOSTATYCZNA **MOBY**

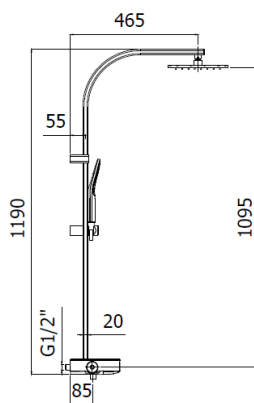

**CR**

CHROM

**4800,00**



**ZCOL638LIQ..**

KOLUMNA NATRYSKOWA TERMOSTATYCZNA

ø225MM

**ZCOL638KLIQ..**

KOLUMNA NATRYSKOWA TERMOSTATYCZNA

ø300MM

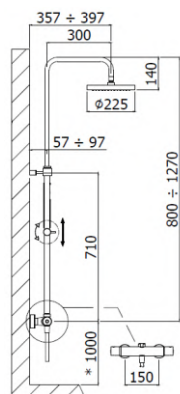

**INDEKS ZCOL638LIQ**

**CR** CHROM **2000,00**

**\*BO** BIAŁY MAT **3300,00**

**NO** CZARNY MAT **3300,00**

**INDEKS ZCOL638KLIQ**

**CR** CHROM **2600,00**

**NO** CZARNY MAT **3800,00**

**MG** GRAFITOWY **4100,00**

# KOLUMNY NATYNKOWE

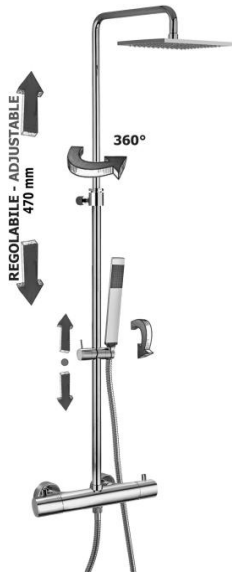

**ZCOL641LIQ..**  
**ZCOL641KLIQ..**

KOLUMNA NATRYSKOWA TERMOSTATYCZNA  
KOLUMNA NATRYSKOWA TERMOSTATYCZNA

**200x200MM**  
**300x300MM**

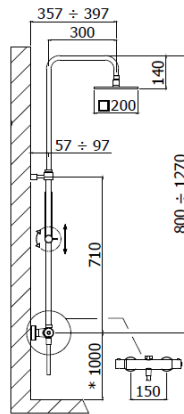

INDEKS **ZCOL641LIQ**

**CR** CHROM **2300,00**  
**NO** CZARNY MAT **3300,00**

INDEKS **ZCOL641KLIQ**

**CR** CHROM **2500,00**  
**NO** CZARNY MAT **3800,00**

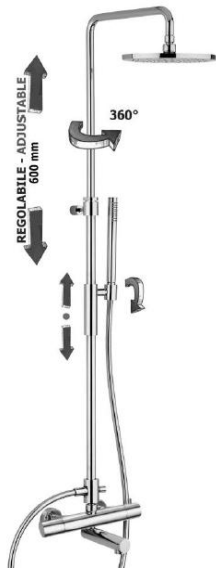

**ZCOL721LIQ..**

KOLUMNA WANNOWATERMOSTATYCZNA LIQ

**CR** CHROM **3400,00**

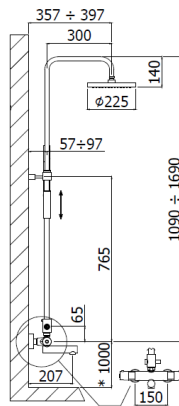

**DV636X..**

KOLUMNA NATRYSKOWA DIVA

**\*CR** CHROM **3000,00**  
**\*FIN.A** **4800,00**  
**\*FIN.B** **6000,00**

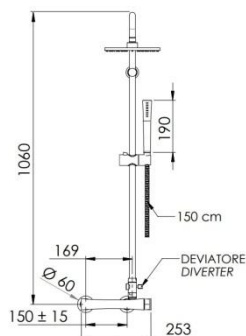

# KOLUMNY NATYNKOWE



**XF636A3MP7820..**

KOLUMNA NATRYSKOWA TERMOSTATYCZNA



<b>CR</b>	CHROM	<b>3000,00</b>
<b>.64</b>	MIEDŹ SZCZOTKOWANA	<b>5100,00</b>
<b>.DP</b>	ZŁOTY SZCZOTKOWANY	<b>6000,00</b>
<b>*.FZ</b>	GUNMETAL	<b>6000,00</b>
<b>*FIN.A</b>		<b>5100,00</b>
<b>*FIN.B</b>		<b>6000,00</b>



**OM636..**

KOLUMNA WANNOWA **OMEGA**

**\*CR** CHROM **2600,00**



**4530584..**

KOLUMNA NATRYSKOWA TERMOSTATYCZNA **PIPER**

**4530584V..**

KOLUMNA NATRYSKOWA TERMOSTATYCZNA **PIPER -ECO-(SITO ABS Ø-200MM)**

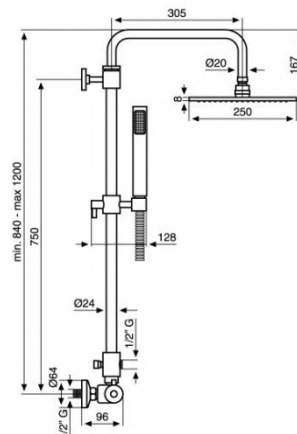

**INDEKS 4530584**

<b>CR</b>	CHROM	<b>2700,00</b>
<b>BIO</b>	BIAŁY MAT	<b>4500,00</b>
<b>*NO</b>	CZARNY MAT	<b>4500,00</b>
<b>*RA</b>	MIEDŹ SZCZOTKOWANA	<b>5300,00</b>
<b>*BR</b>	STARE ZŁOTO	<b>5300,00</b>
<b>*GF</b>	GRAFITOWY	<b>6500,00</b>
<b>OR</b>	ZŁOTY BŁYSZCZĄCY	<b>8100,00</b>

**NO** CZARNY MAT **3900,00**

# KOLUMNY NATYNKOWE



**12100218..** KOLUMNA NATRYSKOWA LAGUNA

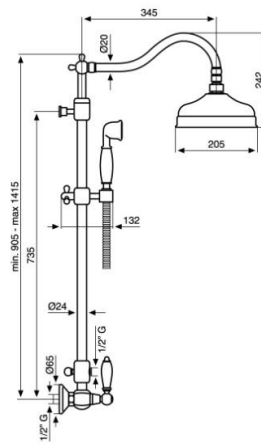

<b>CR</b>	CHROM	<b>3000,00</b>
<b>*CRSWNE</b>	CHROM+SWAROVSKI	<b>3800,00</b>
<b>BR</b>	STARE ZŁOTO	<b>5500,00</b>
<b>*OR</b>	ZŁOTY BŁYSZCZĄCY	<b>7600,00</b>
<b>*RA</b>	MIEDŹ SZCZOTKOWANA	<b>5000,00</b>





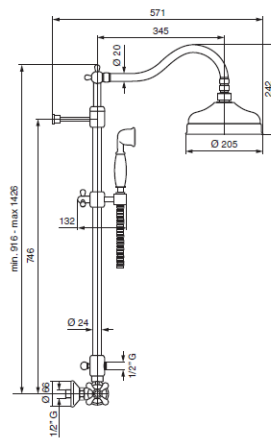





**1230518..** KOLUMNA NATRYSKOWA TERMOSTATYCZNA LAGUNA II

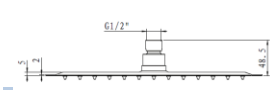



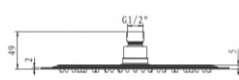

<b>*CR</b>	CHROM	<b>3600,00</b>
<b>*BR</b>	STARE ZŁOTO	<b>5800,00</b>
<b>*OR</b>	ZŁOTY BŁYSZCZĄCY	<b>8900,00</b>
<b>*RA</b>	MIEDŹ SZCZOTKOWANA	<b>5800,00</b>

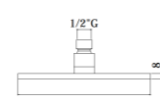

## DESZCZOWNICE I RAMIONA

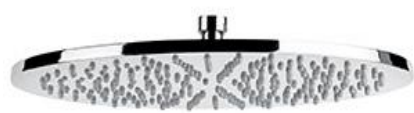
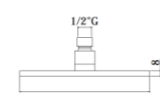

				
<b>SNK..</b>	SITO NATRYSKOWE KWADRATOWE <b>ULTRA SLIM</b>		<b>250</b> <b>300</b>	25X25CM 30X30CM <b>320,00</b> <b>400,00</b>

				
<b>SNO..</b>	SITO NATRYSKOWE OKRĄGŁE <b>ULTRA SLIM</b>		<b>250</b> <b>300</b>	∅25CM ∅30CM <b>320,00</b> <b>400,00</b>

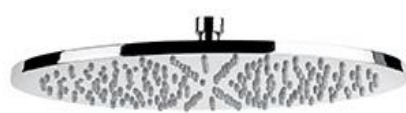
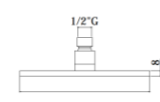
				
<b>ZSOF074..</b>	SITO NATRYSKOWE <b>MASTER</b>	<b>∅225MM</b>	<b>-PAFFONI-</b>	
				<b>CR</b> CHROM <b>360,00</b> <b>BO</b> BIAŁY MAT <b>660,00</b> <b>NO</b> CZARNY MAT <b>660,00</b> <b>ST</b> STAL SZCZOTKOWANA <b>800,00</b> <b>MG</b> GRAFITOWY <b>700,00</b> <b>RMSP</b> MIEDŹ SZCZOTKOWANA <b>1200,00</b> <b>HG</b> ŻŁOTY BŁYSZCZĄCY <b>1150,00</b> <b>*HGSP</b> ŻŁOTY SZCZOTKOWANY <b>1250,00</b>

				
<b>ZSOF079..</b>	SITO NATRYSKOWE <b>MASTER KING</b>	<b>∅300MM</b>	<b>-PAFFONI-</b>	
				<b>CR</b> CHROM <b>660,00</b> <b>NO</b> CZARNY MAT <b>1300,00</b> <b>ST</b> STAL SZCZOTKOWANA <b>1500,00</b> <b>MG</b> GRAFITOWY <b>1300,00</b> <b>RMSP</b> MIEDŹ SZCZOTKOWANA <b>2550,00</b> <b>HG</b> ŻŁOTY BŁYSZCZĄCY <b>2400,00</b> <b>*HGSP</b> ŻŁOTY SZCZOTKOWANY <b>2600,00</b>

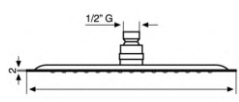
				
<b>C06657-25..</b>	SITO NATRYSKOWE	<b>∅250MM</b>	<b>-EMMEVI-</b>	
<b>C06657-30..</b>	SITO NATRYSKOWE	<b>∅300MM</b>	<b>-EMMEVI-</b>	
				<b>INDEKS C06657-25</b> <b>CR</b> CHROM <b>720,00</b> <b>BIO</b> BIAŁY MAT <b>1350,00</b> <b>*RA</b> MIEDŹ SZCZOTKOWANA <b>1400,00</b> <b>*BR</b> STARE ŻŁOTO <b>1400,00</b> <b>*GF</b> GRAFITOWY <b>1560,00</b> <b>TS</b> TUSCAN <b>1560,00</b> <b>OR</b> ŻŁOTY BŁYSZCZĄCY <b>1900,00</b>  <b>INDEKS C06657-30</b> <b>CR</b> CHROM <b>1260,00</b> <b>BIO</b> BIAŁY MAT <b>1800,00</b> <b>NO</b> CZARNY MAT <b>1800,00</b> <b>OR</b> ŻŁOTY BŁYSZCZĄCY <b>2460,00</b>

				
<b>ZSOF093..</b>	SITO NATRYSKOWE <b>BAHAMAS</b>	<b>∅230MM</b>	<b>-PAFFONI-</b>	
<b>ZSOF094..</b>	SITO NATRYSKOWE <b>JAMAICA</b>	<b>∅300MM</b>	<b>-PAFFONI-</b>	
<b>ZSOF103..</b>	SITO NATRYSKOWE <b>ENERGY</b>	<b>∅400MM</b>	<b>-PAFFONI-</b>	
				<b>INDEKS ZSOF093</b> <b>CR</b> CHROM <b>310,00</b>  <b>INDEKS ZSOF094</b> <b>CR</b> CHROM <b>470,00</b>  <b>INDEKS ZSOF103</b> <b>CR</b> CHROM <b>1300,00</b>

# DESZCZOWNICE



**ZSOF075..** SITO NATRYSKOWE SYNCRO 200x200MM

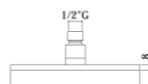

-PAFFONI-



<b>CR</b>	CHROM	<b>360,00</b>
<b>*BO</b>	BIAŁY MAT	<b>700,00</b>
<b>NO</b>	CZARNY MAT	<b>700,00</b>
<b>ST</b>	STAL SZCZOTKOWANA	<b>800,00</b>



**ZSOF078..** SITO NATRYSKOWE SYNCRO KING 300x300MM  
**C06658..** SITO NATRYSKOWE SQUARE 300x300MM

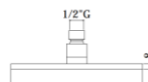

-PAFFONI-

-EMMEVI-



<b>INDEKS ZSOF078</b>		
<b>CR</b>	CHROM	<b>700,00</b>
<b>NO</b>	CZARNY MAT	<b>1400,00</b>
<b>*ST</b>	STAL SZCZOTKOWANA	<b>1500,00</b>

<b>INDEKS C06658</b>		
<b>CR</b>	CHROM	<b>1350,00</b>
<b>*BIO</b>	BIAŁY MAT	<b>1900,00</b>
<b>NO</b>	CZARNY MAT	<b>1900,00</b>
<b>*GF</b>	GRAFITOWY	<b>2900,00</b>
<b>*OR</b>	ZŁOTY BŁYSZCZĄCY	<b>2600,00</b>



**ZSOF095..** SITO NATRYSKOWE HAWAI 200x200MM  
**ZSOF096..** SITO NATRYSKOWE ZANZIBAR 300x300MM  
**ZSOF104..** SITO NATRYSKOWE ORIGINAL 400x400MM

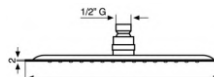

-PAFFONI-

-PAFFONI-

-PAFFONI-



<b>INDEKS ZSOF095</b>		
<b>CR</b>	CHROM	<b>350,00</b>

<b>INDEKS ZSOF096</b>		
<b>CR</b>	CHROM	<b>550,00</b>

<b>INDEKS ZSOF104</b>		
<b>CR</b>	CHROM	<b>1300,00</b>



**C00655..** SITO NATRYSKOWE Ø205MM

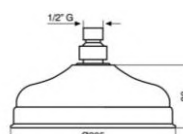

-EMMEVI-



<b>CR</b>	CHROM	<b>705,00</b>
<b>BR</b>	STARE ZŁOTO	<b>1020,00</b>
<b>*RA</b>	MIEDŹ SZCZOTKOWANA	<b>1020,00</b>
<b>*OR</b>	ZŁOTY BŁYSZCZĄCY	<b>1480,00</b>

<b>INDEKS ZSOF035</b>		
<b>CR</b>	CHROM	<b>200,00</b>

<b>INDEKS ZSOF034</b>		
<b>CR</b>	CHROM	<b>225,00</b>
<b>BO</b>	BIAŁY MAT	<b>350,00</b>
<b>NO</b>	CZARNY MAT	<b>350,00</b>
<b>ST</b>	STAL SZCZOTKOWANA	<b>450,00</b>
<b>MG</b>	GRAFITOWY	<b>350,00</b>
<b>RMSP</b>	MIEDŹ SZCZOTKOWANA	<b>800,00</b>
<b>HG</b>	ZŁOTY BŁYSZCZĄCY	<b>750,00</b>
<b>*HGSP</b>	ZŁOTY SZCZOTKOWANY	<b>800,00</b>



**ZSOF035..** RAMIĘ ŚCIENNE L-300MM  
**ZSOF034..** RAMIĘ ŚCIENNE L-400MM  
**C00679..** RAMIĘ ŚCIENNE L-400MM

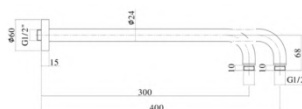

-PAFFONI-

-PAFFONI-

-EMMEVI-

<b>INDEKS C00679</b>		
<b>CR</b>	CHROM	<b>230,00</b>
<b>BIO</b>	BIAŁY MAT	<b>350,00</b>
<b>*RA</b>	MIEDŹ SZCZOTKOWANA	<b>400,00</b>
<b>*GF</b>	GRAFITOWY	<b>480,00</b>
<b>TS</b>	TUSCAN	<b>480,00</b>
<b>OR</b>	ZŁOTY BŁYSZCZĄCY	<b>580,00</b>



<b>ZSOF064..</b>	RAMIĘ SUFITOWE	<b>L-120MM</b>
<b>C00680..</b>	RAMIĘ SUFITOWE	<b>L-200MM</b>
<b>A557-30..</b>	RAMIĘ SUFITOWE	<b>L-300MM</b>
<b>A557-40..</b>	RAMIĘ SUFITOWE	<b>L-400MM</b>

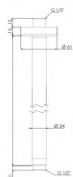

-DANIEL-  
-EMMEVI-  
-DANIEL-  
-DANIEL-

### INDEKS ZSOF064

<b>CR</b>	CHROM	<b>130,00</b>
<b>*BO</b>	BIAŁY MAT	<b>220,00</b>
<b>*NO</b>	CZARNY MAT	<b>220,00</b>
<b>*ST</b>	STAL SZCZOTKOWANA	<b>240,00</b>

### INDEKS C00680

<b>CR</b>	CHROM	<b>175,00</b>
<b>*BIO</b>	BIAŁY MAT	<b>320,00</b>
<b>NO</b>	CZARNY MAT	<b>320,00</b>
<b>OR</b>	ZŁOTY BŁYSZCZĄCY	<b>530,00</b>

### INDEKS A557-30

<b>CR</b>	CHROM	<b>260,00</b>
<b>*FIN.A</b>		<b>420,00</b>
<b>*FIN.B</b>		<b>520,00</b>

### INDEKS A557-40

<b>CR</b>	CHROM	<b>280,00</b>
<b>*FIN.A</b>		<b>450,00</b>
<b>*FIN.B</b>		<b>560,00</b>



<b>A553Q-30..</b>	RAMIĘ ŚCIENNE	<b>L-300MM</b>
<b>ZSOF063-35..</b>	RAMIĘ ŚCIENNE	<b>L-350MM</b>
<b>ZSOF063..</b>	RAMIĘ ŚCIENNE	<b>L-400MM</b>



-DANIEL-  
-PAFFONI-  
-PAFFONI-

### INDEKS A553Q-30

<b>CR</b>	CHROM	<b>290,00</b>
-----------	-------	---------------

### INDEKS ZSOF063-35

<b>CR</b>	CHROM	<b>350,00</b>
<b>*NO</b>	CZARNY MAT	<b>540,00</b>
<b>*ST</b>	STAL SZCZOTKOWANA	<b>660,00</b>

### INDEKS ZSOF063

<b>CR</b>	CHROM	<b>360,00</b>
<b>*BO</b>	BIAŁY MAT	<b>555,00</b>
<b>NO</b>	CZARNY MAT	<b>555,00</b>
<b>ST</b>	STAL SZCZOTKOWANA	<b>680,00</b>



<b>ZSOF118..</b>	RAMIĘ SUFITOWE	<b>L-120MM</b>
<b>A557Q-20..</b>	RAMIĘ SUFITOWE	<b>L-200MM</b>
<b>A557Q-30..</b>	RAMIĘ SUFITOWE	<b>L-300MM</b>
<b>A557Q-40..</b>	RAMIĘ SUFITOWE	<b>L-400MM</b>

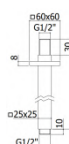

-PAFFONI-  
-DANIEL-  
-DANIEL-  
-DANIEL-

### INDEKS ZSOF118

<b>CR</b>	CHROM	<b>260,00</b>
-----------	-------	---------------

### INDEKS A557Q-20

<b>CR</b>	CHROM	<b>300,00</b>
<b>NO</b>	CZARNY MAT	<b>420,00</b>

### INDEKS A557Q-30

<b>CR</b>	CHROM	<b>360,00</b>
<b>*FIN.A</b>		<b>580,00</b>
<b>*FIN.B</b>		<b>720,00</b>

### INDEKS A557Q-40

<b>CR</b>	CHROM	<b>420,00</b>
<b>*FIN.A</b>		<b>680,00</b>
<b>*FIN.B</b>		<b>840,00</b>



<b>C00684..</b>	RAMIĘ ŚCIENNE	<b>L-325MM</b>
-----------------	---------------	----------------

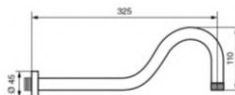

-EMMEVI-

<b>CR</b>	CHROM	<b>305,00</b>
<b>BR</b>	STARE ZŁOTO	<b>540,00</b>
<b>*RA</b>	MIEDŹ SZCZOTKOWANA	<b>540,00</b>
<b>*OR</b>	ZŁOTY BŁYSZCZĄCY	<b>790,00</b>



<b>52100..</b>	RAMIĘ ŚCIENNE (OBROTOWE)	<b>L-365MM</b>
----------------	--------------------------	----------------

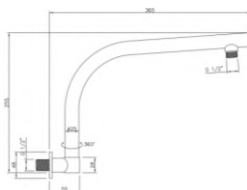

<b>CR</b>	CHROM	<b>740,00</b>
-----------	-------	---------------

# DESZCZOWNICE

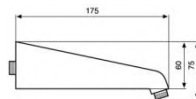

**C00650..** RAMIĘ ŚCIENNE L-175MM WANDALOODPORNE -EMMEVI- **CR** CHROM **190,00**



**A520NR ..** ZAWÓR ZWROTNY -DANIEL- **CR** CHROM **40,00**

## DESZCZOWNICE SUFITOWE

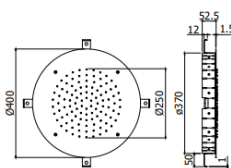

**ZSOF303..** SITO NATRYSKOWE SUFITOWE **400MM**  
**ZSOF304..** SITO NATRYSKOWE SUFITOWE **530MM**

-PAFFONI-

-PAFFONI-

**INDEKS ZSOF303**  
**CR** CHROM **2400,00**

**INDEKS ZSOF304**  
**\*CR** CHROM **3000,00**

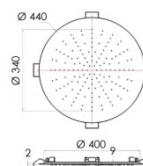

**A578EF-CM34..** SITO NATRYSKOWE SUFITOWE **340MM**  
**A578EF-CM40..** SITO NATRYSKOWE SUFITOWE **440MM**

-DANIEL-

-DANIEL-

**INDEKS A578EF-CM34**  
**\*CR** CHROM **1800,00**  
**\*.15** CZARNY MAT **2900,00**

**INDEKS A578EF-CM44**  
**\*CR** CHROM **2100,00**  
**.15** CZARNY MAT **3400,00**  
**\*.64** MIEDŹ SZCZOTKOWANA **3400,00**  
**\*.DP** ŻŁOTY SZCZOTKOWANY **4550,00**

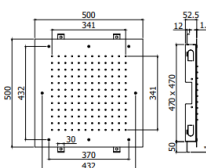

**ZSOF300..** SITO NATRYSKOWE SUFITOWE **430x430MM**  
**ZSOF301..** SITO NATRYSKOWE SUFITOWE **500x500MM**

-PAFFONI-

-PAFFONI-

**INDEKS ZSOF300**  
**\*CR** CHROM **3000,00**

**INDEKS ZSOF301**  
**CR** CHROM **3200,00**

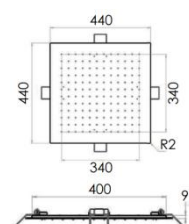

**A579EF-CM34..** SITO NATRYSKOWE SUFITOWE **340x340MM**  
**A579EF-CM44..** SITO NATRYSKOWE SUFITOWE **440x440MM**

-DANIEL-

-DANIEL-

**INDEKS A579EF-CM34**  
**\*CR** CHROM **2100,00**  
**\*.15** CZARNY MAT **3600,00**

**INDEKS A579EF-CM44**  
**\*CR** CHROM **2500,00**  
**.15** CZARNY MAT **4000,00**  
**\*.64** MIEDŹ SZCZOTKOWANA **4000,00**  
**\*.DP** ŻŁOTY SZCZOTKOWANY **5300,00**



# DESZCZOWNICE

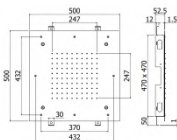

**ZSOF129..** SITO NATRYSKOWE SUFITOWE (4 NAPOWIETRZACZE) 500x500MM

**\*CR** CHROM

**3900,00**

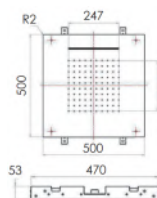

**A579SFCM50C..** SITO NATRYSKOWE SUFITOWE (KASKADA)

**500x500MM -DANIEL-**

**CR** CHROM

**5500,00**

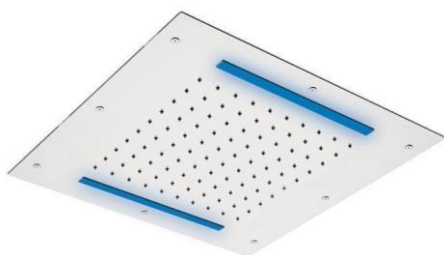

**A579JCM50..** SITO NATRYSKOWE SUFITOWE **LED** 500x500MM

**-DANIEL-**

**CR** CHROM

**8500,00**

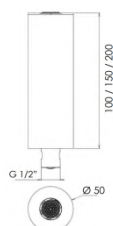

**A578PECM15..** SITO NATRYSKOWE SUFITOWE

**50x150MM**

**-DANIEL-**

**\*CR** CHROM

**1400,00**

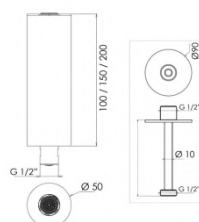

**A578PELCM10..** SITO NATRYSKOWE SUFITOWE

**50x100MM**

**-DANIEL-**

**\*CR** CHROM

**1950,00**

## DESZCZOWNICE ŚCIENNE I DYSZE BOCZNE



**A566CA..**

SITO NATRYSKOWE ŚCIENNE

500x200MM

-DANIEL-

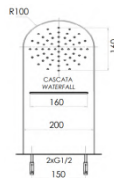

\*CR

CHROM

1900,00

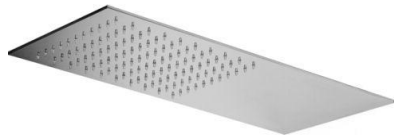

**ZSOF117..**

SITO NATRYSKOWE ŚCIENNE SLIM

500x220MM

-PAFFONI-

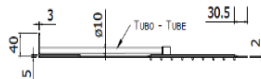

CR

CHROM

2200,00



**ZSOF098..**

SITO NATRYSKOWE ŚCIENNE FREE

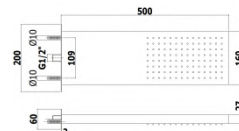

500MM

-PAFFONI-



CR

CHROM

1900,00

INDEKS ZSOF098

**ZSOF099..**

SITO NATRYSKOWE ŚCIENNE FREE (KASKADA)

500MM

-PAFFONI-

CR

CHROM

2100,00

INDEKS ZSOF099

\*BO

BIAŁY MAT

2900,00

\*NO

CZARNY MAT

2900,00

\*ST

STAL SZCZOTKOWANA

3600,00

\*HG

ZŁOTY BŁYSZCZĄCY

5200,00

\*HGSP

ZŁOTY SZCZOTKOWANY

5600,00



**ZSOF061..**

DYSZA BOCZNA Z HYDROMASAŻEM TONDO - METAL

-PAFFONI-

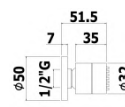

CR

CHROM

185,00



**ZSOF062..**

DYSZA BOCZNA Z HYDROMASAŻEM QUADRO - METAL

-PAFFONI-

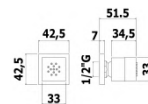

CR

CHROM

270,00



**C06640..**

DYSZA BOCZNA Z HYDROMASAŻEM CIRCLE-ABS

-PAFFONI-



CR

CHROM

380,00

\*BO

BIAŁY MAT

770,00

\*NO

CZARNY MAT

770,00

\*ST

STAL SZCZOTKOWANA

1000,00

\*HG

ZŁOTY BŁYSZCZĄCY

1500,00

\*HGSP

ZŁOTY SZCZOTKOWANY

1600,00



**C06641..**

DYSZA BOCZNA Z HYDROMASAŻEM SQUARE-ABS

-PAFFONI-

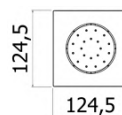

CR

CHROM

510,00

\*BO

BIAŁY MAT

780,00

\*NO

CZARNY MAT

780,00

\*ST

STAL SZCZOTKOWANA

1050,00

\*HG

ZŁOTY BŁYSZCZĄCY

1600,00

\*HGSP

ZŁOTY SZCZOTKOWANY

1700,00

# ZESTAWY NATRYSKOWE



**C06685..**

ZESTAW NATRYSKOWY **NEFER**

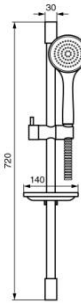

-EMMEVI-



**CR**

CHROM

**370,00**



**C02541..**

ZESTAW NATRYSKOWY **LAGUNA**

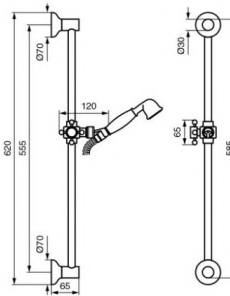

-EMMEVI-



**CR**

CHROM

**580,00**

**\*CO**

CHROM/ZŁOTO

**1140,00**

**BR**

STARÉ ZŁOTO

**1150,00**

**\*NO**

CZARNY MAT

**1200,00**

**\*OR**

ZŁOTY BŁYSZCZĄCY

**1510,00**

**\*RA**

MIEDŹ SZCZOTKOWANA

**1150,00**



**C02669..**

ZESTAW NATRYSKOWY **LIFE**

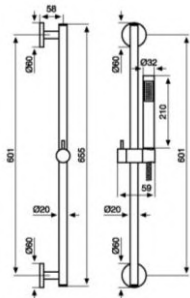

-EMMEVI-



**CR**

CHROM

**690,00**

**BIO**

BIALY MAT

**1000,00**

**NO**

CZARNY MAT

**1000,00**

**\*NS**

STAL SZCZOTKOWANA

**1300,00**

**\*GF**

GRAFITOWY

**1800,00**

**\*RA**

MIEDŹ SZCZOTKOWANA

**1300,00**

**TS**

TUSCAN

**1800,00**

**OR**

ZŁOTY BŁYSZCZĄCY

**2000,00**



**C02760..**

ZESTAW NATRYSKOWY Z PODŁĄCZENIEM PODTYNKOWYM

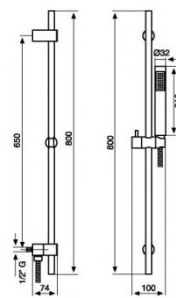

-EMMEVI-



**CR**

CHROM

**430,00**

# ZESTAWY NATRYSKOWE



**ZSAL079..**

ZESTAW NATRYSKOWY **LEVEL**

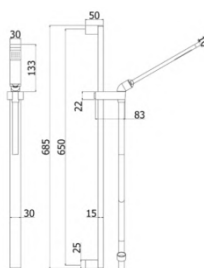

**-PAFFONI-**



**CR**

CHROM

**440,00**



**ZSAL112..**

ZESTAW NATRYSKOWY **TRIESTE**

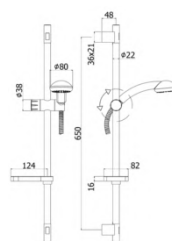

**-PAFFONI-**



**CR**

CHROM

**160,00**



**ZSAL135..**

ZESTAW NATRYSKOWY **LIFE**

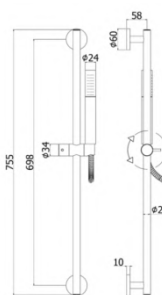

**-PAFFONI-**



**CR**

CHROM

**560,00**

**BO**

BIAŁY MAT

**750,00**

**NO**

CZARNY MAT

**750,00**

**ST**

STAL SZCZOTKOWANA

**950,00**

**MG**

GRAFITOWY

**850,00**

**RMSP**

MIEDŹ SZCZOTKOWANA

**1950,00**

**HG**

ZŁOTY BŁYSZCZĄCY

**1830,00**

**\*HGSP**

ZŁOTY SZCZOTKOWANY

**1950,00**



**ZSAL145..**

ZESTAW NATRYSKOWY **CITY**

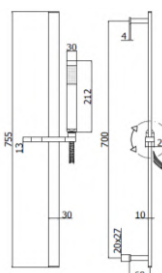

**-PAFFONI-**



**CR**

CHROM

**650,00**

**NO**

CZARNY MAT

**850,00**

**\*ST**

STAL SZCZOTKOWANA

**1100,00**

# ZESTAWY NATRYSKOWE



**ZSAL146..**

ZESTAW NATRYSKOWY **GINEVRA**

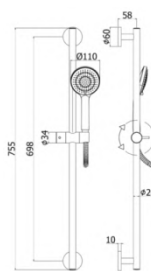

**-PAFFONI-**



**CR** CHROM  
**BO** BIAŁY MAT  
**NO** CZARNY MAT

**560,00**

**730,00**

**730,00**



**ZSAL150..**

ZESTAW NATRYSKOWY **STICK NEW**

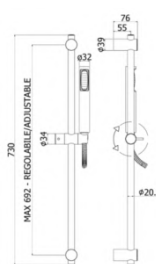

**-PAFFONI-**



**CR** CHROM

**300,00**



**ZSAL194..**

ZESTAW NATRYSKOWY **BRIO**

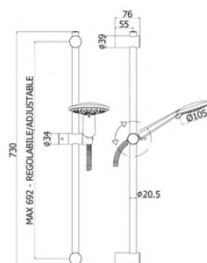

**-PAFFONI-**



**CR** CHROM

**230,00**



**A335431..**

ZESTAW NATRYSKOWY **STICK**

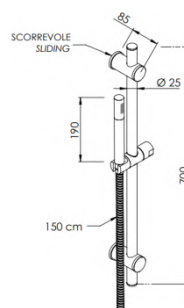

**-DANIEL-**



**CR** CHROM

**360,00**

# ZESTAWY NATRYSKOWE



**A340435..**

ZESTAW NATRYSKOWY TOKYO

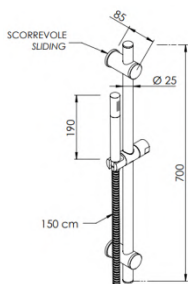

**-DANIEL-**



**\*CR** CHROM  
**\*FIN.A**  
**\*FIN.B**

**750,00**  
**1170,00**  
**1450,00**



**ZSAL088..**

SZTYCA NATRYSKOWA 650MM

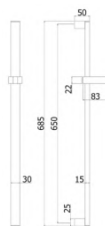

**-PAFFONI-**

**CR** CHROM

**300,00**



**ZSAL106..**

SZTYCA NATRYSKOWA 692MM

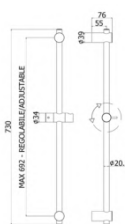

**-PAFFONI-**

**CR** CHROM

**200,00**



**ZSAL116..**

SZTYCA NATRYSKOWA 755MM



**-PAFFONI-**

**CR** CHROM **480,00**  
**\*BO** BIAŁY MAT **600,00**  
**NO** CZARNY MAT **600,00**  
**ST** STAL SZCZOTKOWANA **700,00**  
**HG** ŻŁOTY **1350,00**  
**\*HGSP** ŻŁOTY SZCZOTKOWANY **1450,00**



**ZSAL080..**

MYDELNICZKA DO NATRYSKU ZSAL 079-088

**-PAFFONI-**

**CR** CHROM

**75,00**



**ZSAL203..**

MYDELNICZKA DO NATRYSKU Ø22MM

**-PAFFONI-**

**CR** CHROM

**45,00**

# RĄCZKI NATRYSKOWE



**RN01..**

RĄCZKA NATRYSKOWA 4F

**GARDA**

-AP-

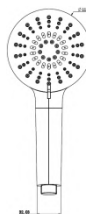

**NO**

CZARNY MAT

**85,00**



**ZDOC067..**

RĄCZKA NATRYSKOWA 1F

**MASTER**

-PAFFONI-

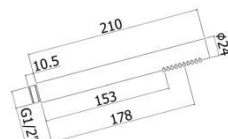

**CR**

CHROM

**130,00**

**\*BO**

BIAŁY MAT

**200,00**

**NO**

CZARNY MAT

**200,00**

**ST**

STAL SZCZOTKOWANA

**230,00**

**MG**

GRAFITOWY

**200,00**

**RMSP**

MIEDŹ SZCZOTKOWANA

**350,00**

**HG**

ZŁOTY BŁYSZCZĄCY

**330,00**

**\*HGSP**

ZŁOTY SZCZOTKOWANY

**350,00**

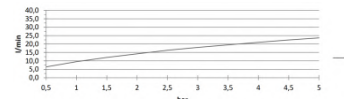

**A435..**

RĄCZKA NATRYSKOWA 1F

**MINIMAL**

-DANIEL-



**\*CR**

CHROM

**130,00**

**\*FIN.A**

**200,00**

**\*FIN.B**

**240,00**



**A431..**

RĄCZKA NATRYSKOWA 1F

**STICK DUE**

-DANIEL-

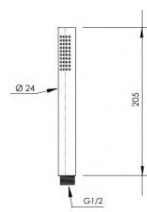

**CR**

CHROM

**60,00**



**ZDOC032..**

RĄCZKA NATRYSKOWA 1F

**STICK**

-PAFFONI-

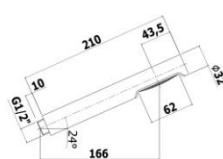

**CR**

CHROM

**70,00**

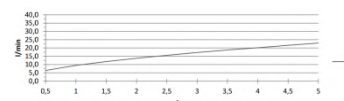

# RĄCZKI NATRYSKOWE



**A443MP..**

RĄCZKA NATRYSKOWA 3F

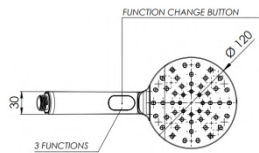

**PULSANTE II**

**-DANIEL-**



**CR**  
**NO**

CHROM  
CZARNY MAT

**95,00**  
**140,00**



**A477..**

RĄCZKA NATRYSKOWA 3F

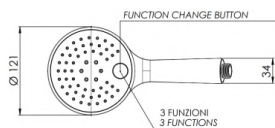

**PULSANTE**

**-DANIEL-**



**CR**

CHROM

**70,00**



**ZDOC076..**

Rączka natryskowa 4F+STOP

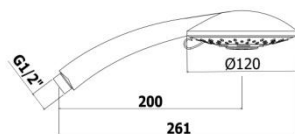

**PRESTIGE**

**-PAFFONI-**

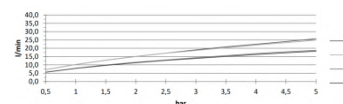

**CR**

CHROM

**85,00**



**ZDOC104..**

RĄCZKA NATRYSKOWA 4F+STOP

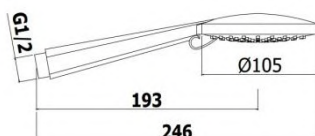

**BRIO**

**-PAFFONI-**

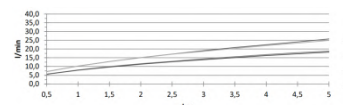

**CR**

CHROM

**85,00**



**ZDOC125..**

RĄCZKA NATRYSKOWA 3F

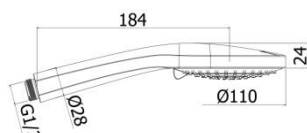

**GINEVRA**

**-PAFFONI-**

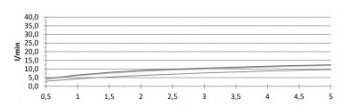

**CR**

CHROM

**160,00**

**BO**

BIAŁY MAT

**190,00**

**NO**

CZARNY MAT

**190,00**



# RĄCZKI NATRYSKOWE



**ZDOC117..** RĄCZKA NATRYSKOWA 1F

**PREMIUM**

**-PAFFONI-**

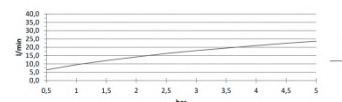
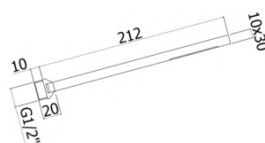

<b>CR</b>	CHROM	<b>150,00</b>
<b>ST</b>	STAL SZCZOTKOWANA	<b>240,00</b>
<b>NO</b>	CZARNY MAT	<b>220,00</b>



**ZDOC054..** RĄCZKA NATRYSKOWA 1F

**LEVEL**

**-PAFFONI-**

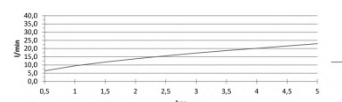
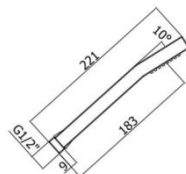

<b>CR</b>	CHROM	<b>65,00</b>
-----------	-------	--------------



**C02465..** RĄCZKA NATRYSKOWA **PULSANTE**

**-EMMEVI-**



<b>CR</b>	CHROM	<b>180,00</b>
-----------	-------	---------------



**C02403..** RĄCZKA NATRYSKOWA 1F

**LAGUNA**

**-EMMEVI-**

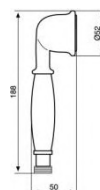

<b>CR</b>	CHROM	<b>125,00</b>
<b>*CO</b>	CHROM/ZŁOTO	<b>240,00</b>
<b>BR</b>	STARE ZŁOTO	<b>230,00</b>
<b>*NO</b>	CZARNY MAT	<b>220,00</b>
<b>*OR</b>	ZŁOTY BŁYSZCZĄCY	<b>325,00</b>
<b>*RA</b>	MIEDŹ SZCZOTKOWANA	<b>230,00</b>



**C02542..** RĄCZKA NATRYSKOWA 1F

**TIFFANY**

**-EMMEVI-**

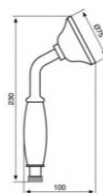

<b>CR</b>	CHROM	<b>160,00</b>
<b>*CO</b>	CHROM/ZŁOTO	<b>320,00</b>
<b>*BR</b>	STARE ZŁOTO	<b>245,00</b>
<b>*OR</b>	ZŁOTY BŁYSZCZĄCY	<b>355,00</b>
<b>*RA</b>	MIEDŹ SZCZOTKOWANA	<b>245,00</b>

# RĄCZKI NATRYSKOWE



**A413CR..**

RĄCZKA ZLEWOZMYWAKOWA 2F

**ABS**

**-DANIEL-**



**CR**

CHROM

**75,00**

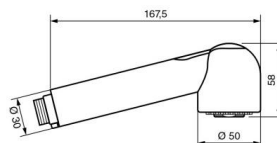

**A537-ZDOC067..** ZESTAW 3W1

**PREMIUM I**

**-PAFFONI-**



**CR**

CHROM

**260,00**

**BO**

BIAŁY MAT

**510,00**

**NO**

CZARNY MAT

**510,00**

**HG**

ZŁOTY BŁYSZCZĄCY

**750,00**

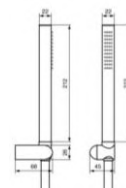

**EM136..**

ZESTAW 3W1

**NEFER**

**-EMMEVI-**



**CR**

CHROM

**185,00**

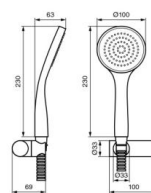

**ZDUP054..**

ZESTAW 3W1

**STICK**

**-PAFFONI-**



**CR**

CHROM

**220,00**

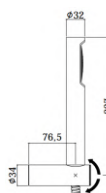

**A54643MP..**

ZESTAW 3W1

**PULSANTE II**

**-DANIEL-**



**CR**

CHROM

**360,00**

**NO**

CZARNY MAT

**600,00**

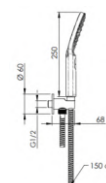

# RĄCZKI NATRYSKOWE



**ZDUP094..** ZESTAW 3W1

**TONDO**

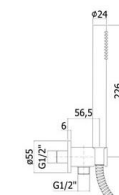

**-PAFFONI-**



<b>CR</b>	CHROM	<b>350,00</b>
<b>BO</b>	BIAŁY MAT	<b>600,00</b>
<b>NO</b>	CZARNY MAT	<b>600,00</b>
<b>ST</b>	STAL SZCZOTKOWANA	<b>700,00</b>
<b>MG</b>	GRAFITOWY	<b>600,00</b>
<b>RMSP</b>	MIEDŹ SZCZOTKOWANA	<b>1100,00</b>
<b>HG</b>	ZŁOTY BŁYSZCZĄCY	<b>1030,00</b>
<b>*HGSP</b>	ZŁOTY SZCZOTKOWANY	<b>1100,00</b>



**EM154..** ZESTAW 3W1

**PIPER**

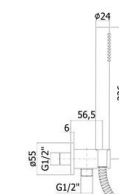

**-EMMEVI-**



<b>CR</b>	CHROM	<b>350,00</b>
<b>BIO</b>	BIAŁY MAT	<b>810,00</b>
<b>NO</b>	CZARNY MAT	<b>810,00</b>
<b>*GF</b>	GRAFITOWY	<b>1050,00</b>
<b>*RA</b>	MIEDŹ SZCZOTKOWANA	<b>860,00</b>
<b>TS</b>	TUSCAN	<b>1050,00</b>
<b>OR</b>	ZŁOTY BŁYSZCZĄCY	<b>1280,00</b>



**A546435..** ZESTAW 3W1

**TOKYO**

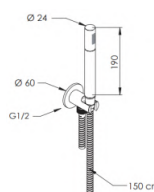

**-DANIEL-**

<b>CR</b>	CHROM	<b>320,00</b>
<b>.64</b>	MIEDŹ SZCZOTKOWANA	<b>1350,00</b>
<b>.DP</b>	ZŁOTY SZCZOTKOWANY	<b>1440,00</b>
<b>*.FZ</b>	GUNMETAL	<b>1500,00</b>
<b>*FIN.A</b>		<b>1350,00</b>
<b>*FIN.B</b>		<b>1440,00</b>



**ZDUP058..** ZESTAW 3W1

**PREMIUM I**

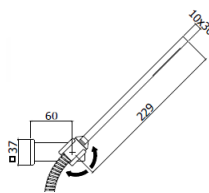

**-PAFFONI-**

<b>CR</b>	CHROM	<b>215,00</b>
<b>*ST</b>	STAL SZCZOTKOWANA	<b>500,00</b>
<b>NO</b>	CZARNY MAT	<b>430,00</b>



**ZDUP095..** ZESTAW 3W1

**PREMIUM II**

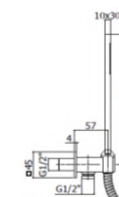

**-PAFFONI-**

<b>CR</b>	CHROM	<b>355,00</b>
<b>ST</b>	STAL SZCZOTKOWANA	<b>850,00</b>
<b>*BO</b>	BIAŁY MAT	<b>650,00</b>
<b>NO</b>	CZARNY MAT	<b>650,00</b>

# RĄCZKI NATRYSKOWE



**A547Q495..** ZESTAW 3W1

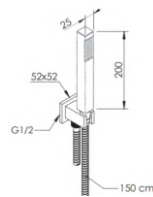

**DANIEL II** -DANIEL-

**\*CR** CHROM 320,00  
**\*FIN.A** 1350,00  
**\*FIN.B** 1440,00



**EM110..** ZESTAW 3W1

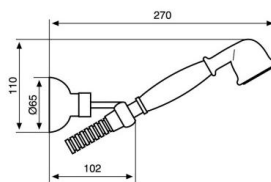

**LAGUNA I** -EMMEVI-

**CR** CHROM 310,00  
**BR** STARE ŻŁOTO 600,00  
**\*NO** CZARNY MAT 610,00  
**\*OR** ŻŁOTY BŁYSZCZĄCY 930,00  
**\*RA** MIEDŹ SZCZOTKOWANA 600,00



**EM157..** ZESTAW 3W1

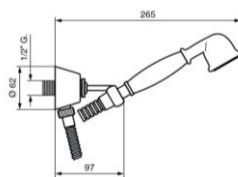

**LAGUNA II** -EMMEVI-

**CR** CHROM 310,00  
**BR** STARE ŻŁOTO 600,00  
**\*NO** CZARNY MAT 610,00  
**\*OR** ŻŁOTY BŁYSZCZĄCY 930,00  
**\*RA** MIEDŹ SZCZOTKOWANA 600,00



**ZDUP087..** ZESTAW 3W1

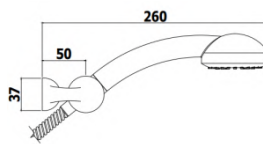

**TRIESTE** -PAFFONI-

**CR** CHROM 170,00



**A520NR..** ZAWÓR ZWROTNY

-DANIEL-

**CR** CHROM 40,00



**ZSUP031..** PRZYŁĄCZE KĄTOWE Z UCHWYTEM

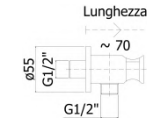

-PAFFONI-

<b>CR</b>	CHROM	170,00
<b>*BO</b>	BIAŁY MAT	270,00
<b>NO</b>	CZARNY MAT	270,00
<b>ST</b>	STAL SZCZOTKOWANA	350,00
<b>MG</b>	GRAFITOWY	270,00
<b>RMSP</b>	MIEDŹ SZCZOTKOWANA	610,00
<b>*HG</b>	ZŁOTY BŁYSZCZĄCY	580,00
<b>*HGSP</b>	ZŁOTY SZCZOTKOWANY	610,00



**C06948..** PRZYŁĄCZE KĄTOWE Z RUCHOMYM UCHWYTEM

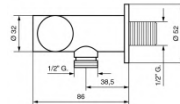

-EMMEVI-

<b>CR</b>	CHROM	265,00
<b>*BIO</b>	BIAŁY MAT	480,00
<b>NO</b>	CZARNY MAT	480,00
<b>*RA</b>	MIEDŹ SZCZOTKOWANA	500,00
<b>*GF</b>	GRAFITOWY	690,00
<b>*OR</b>	ZŁOTY BŁYSZCZĄCY	690,00
<b>TS</b>	TUSCAN	690,00



**ZACC130..** PRZYŁĄCZE KĄTOWE METALOWE



-PAFFONI-

<b>CR</b>	CHROM	65,00
<b>*BO</b>	BIAŁY MAT	115,00
<b>NO</b>	CZARNY MAT	115,00
<b>ST</b>	STAL SZCZOTKOWANA	120,00
<b>MG</b>	GRAFITOWY	115,00
<b>RMSP</b>	MIEDŹ SZCZOTKOWANA	115,00
<b>*OR</b>	ZŁOTY BŁYSZCZĄCY	180,00
<b>TS</b>	TUSCAN	300,00
<b>*FIN.A</b>		115,00
<b>*FIN.B</b>		140,00

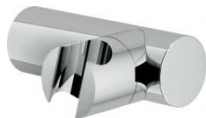

**ZSUP022..** UCHWYT PUNKTOWY **ABS**

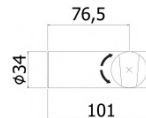

-PAFFONI-

<b>CR</b>	CHROM	55,00
<b>*ST</b>	STAL SZCZOTKOWANA	120,00



**ZSUP020..** UCHWYT PUNKTOWY **METAL**

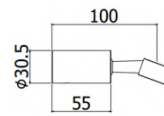

-PAFFONI-

<b>CR</b>	CHROM	190,00
<b>*BO</b>	BIAŁY MAT	260,00
<b>NO</b>	CZARNY MAT	260,00
<b>ST</b>	STAL SZCZOTKOWANA	340,00
<b>MG</b>	GRAFITOWY	260,00
<b>RMSP</b>	MIEDŹ SZCZOTKOWANA	460,00
<b>HG</b>	ZŁOTY BŁYSZCZĄCY	420,00
<b>*HGSP</b>	ZŁOTY SZCZOTKOWANY	460,00



**ZSUP010..** UCHWYT PUNKTOWY **ABS**

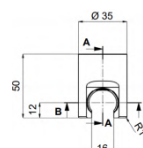

-PAFFONI-

<b>INDEKS ZSUP010</b>		
<b>CR</b>	CHROM	30,00
<b>BO</b>	BIAŁY MAT	40,00
<b>NO</b>	CZARNY MAT	40,00

**A537..** UCHWYT PUNKTOWY **METAL**

-DANIEL-

<b>INDEKS A537</b>		
<b>CR</b>	CHROM	90,00
<b>DO</b>	ZŁOTY BŁYSZCZĄCY	180,00
<b>*FIN.A</b>		140,00
<b>*FIN.B</b>		180,00



**ZSUP032..** PRZYŁĄCZE KĄTOWE Z UCHWYTEM

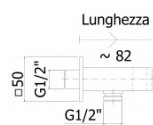

-PAFFONI-

<b>CR</b>	CHROM	<b>175,00</b>
<b>*BO</b>	BIAŁY MAT	<b>290,00</b>
<b>NO</b>	CZARNY MAT	<b>290,00</b>
<b>ST</b>	STAL SZCZOTKOWANA	<b>380,00</b>



**C06949..** PRZYŁĄCZE KĄTOWE Z RUCHOMYM UCHWYTEM

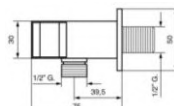

-EMMEVI-

<b>CR</b>	CHROM	<b>280,00</b>
-----------	-------	---------------



**ZACC238..** PRZYŁĄCZE KĄTOWE METALOWE

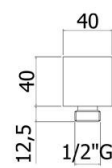

-PAFFONI-

<b>CR</b>	CHROM	<b>190,00</b>
<b>NO</b>	CZARNY MAT	<b>310,00</b>
<b>*ST</b>	STAL SZCZOTKOWANA	<b>360,00</b>



**ZSUP025..** UCHWYT PUNKTOWY **ABS**

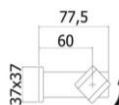

-PAFFONI-

<b>CR</b>	CHROM	<b>65,00</b>
<b>*ST</b>	STAL SZCZOTKOWANA	<b>120,00</b>



**ZSUP026..** UCHWYT PUNKTOWY **ABS**

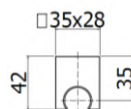

-PAFFONI-

<b>CR</b>	CHROM	<b>30,00</b>
-----------	-------	--------------



**C06935..** PRZYŁĄCZE KĄTOWE Z RUCHOMYM UCHWYTEM



-EMMEVI-

<b>CR</b>	CHROM	<b>165,00</b>
<b>BR</b>	STARE ŻŁOTO	<b>300,00</b>
<b>*NO</b>	CZARNY MAT	<b>290,00</b>
<b>*OR</b>	ŻŁOTY BŁYSZCZĄCY	<b>430,00</b>
<b>*RA</b>	MIEDŹ SZCZOTKOWANA	<b>300,00</b>



**C02529..** UCHWYT PUNKTOWY **METAL**

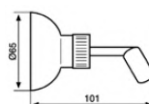

-EMMEVI-

<b>CR</b>	CHROM	<b>110,00</b>
<b>BR</b>	STARE ŻŁOTO	<b>200,00</b>
<b>*NO</b>	CZARNY MAT	<b>165,00</b>
<b>*OR</b>	ŻŁOTY BŁYSZCZĄCY	<b>260,00</b>
<b>*RA</b>	MIEDŹ SZCZOTKOWANA	<b>200,00</b>

# PRZYŁĄCZA



**C06908..**

PRZYŁĄCZE KĄTOWE METALOWE

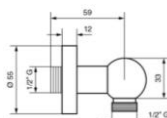

-EMMEVI-

<b>CR</b>	CHROM	<b>215,00</b>
<b>BR</b>	STARE ZŁOTO	<b>405,00</b>
<b>*NO</b>	CZARNY MAT	<b>370,00</b>
<b>*OR</b>	ZŁOTY BŁYSZCZĄCY	<b>520,00</b>
<b>*RA</b>	MIEDŹ SZCZOTKOWANA	<b>405,00</b>

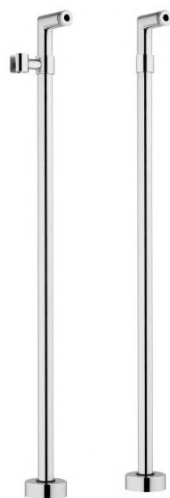

**V-1051..**

NOGI PRZYŁĄCZENIOWE Z UCHWYTEM L-800MM (KOMPLET)

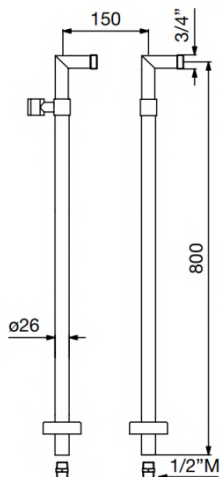

-VICARIO-

<b>CR</b>	CHROM	<b>1700,00</b>
<b>BR</b>	STARE ZŁOTO	<b>2400,00</b>
<b>*BIO</b>	BIAŁY MAT	<b>2400,00</b>
<b>*NO</b>	CZARNY MAT	<b>2400,00</b>
<b>*OR</b>	ZŁOTY ŚWIECĄCY	<b>2600,00</b>
<b>*RA</b>	MIEDŹ SZCZOTKOWANA	<b>2400,00</b>



**PD467..**

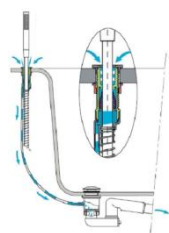

PRZELOTKA WANNOWA Z WĘŻEM NA SPRĘŻYNIE I ODPROWADZENIEM SKROPLIN

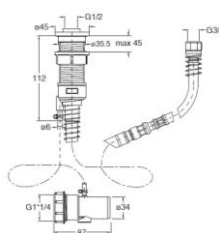

<b>CR</b>	CHROM	<b>670,00</b>
<b>.13</b>	CZARNY MAT	<b>830,00</b>



**PD468..**

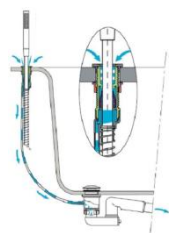

PRZELOTKA WANNOWA Z WĘŻEM NA SPRĘŻYNIE I ODPROWADZENIEM SKROPLIN

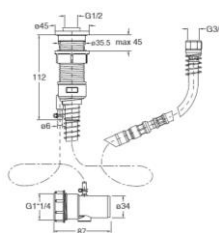

<b>CR</b>	CHROM	<b>800,00</b>
<b>.13</b>	CZARNY MAT	<b>930,00</b>



**BO5220..**

SYFON BRODZIKOWY **ULTRA NISKI**

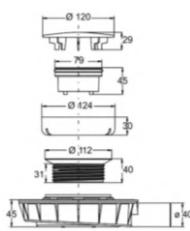

-BONOMINI-

<b>CR</b>	CHROM	<b>160,00</b>
-----------	-------	---------------



**ZBOC105..** WYLEWKA ŚCIENNA L-125MM  
**ZBOC081..** WYLEWKA ŚCIENNA L-175MM  
**ZBOC082..** WYLEWKA ŚCIENNA L-245MM

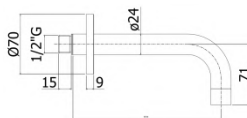

-PAFFONI-

**CR** CHROM 310,00  
**\*ST** STAL SZCZOTKOWANA 530,00



**ZBOC103..** WYLEWKA ŚCIENNA L-125MM  
**ZBOC045..** WYLEWKA ŚCIENNA L-175MM  
**ZBOC046..** WYLEWKA ŚCIENNA L-245MM

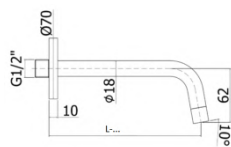

-PAFFONI-

**CR** CHROM 310,00  
**BO** BIAŁY MAT 390,00  
**NO** CZARNY MAT 390,00  
**ST** STAL SZCZOTKOWANA 530,00  
**MG** GRAFITOWY 390,00  
**RMSP** MIEDŹ SZCZOTKOWANA 530,00  
**HG** ŻŁOTY BŁYSZCZĄCY 890,00  
**\*HGSP** ŻŁOTY SZCZOTKOWANY 940,00



**TK4704..** WYLEWKA ŚCIENNA L-160MM

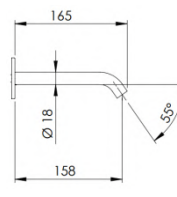

-DANIEL-

**CR** CHROM 490,00  
**.64** MIEDŹ SZCZOTKOWANA 780,00  
**.DP** ŻŁOTY SZCZOTKOWANY 970,00  
**\*FIN.A** 780,00  
**\*FIN.B** 970,00



**C00626F-18..** WYLEWKA ŚCIENNA L-180MM  
**C00626F-25..** WYLEWKA ŚCIENNA L-240MM

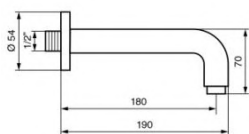

-EMMEVI-

-EMMEVI-

**CR** CHROM 305,00  
**BIO** BIAŁY MAT 370,00  
**NO** CZARNY MAT 370,00  
**\*RA** MIEDŹ SZCZOTKOWANA 400,00  
**\*GF** GRAFITOWY 555,00  
**TS** TUSCAN 555,00  
**OR** ŻŁOTY BŁYSZCZĄCY 600,00



**SK4704..** WYLEWKA ŚCIENNA L-180MM

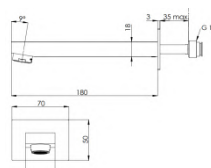

-DANIEL-

**CR** CHROM 620,00  
**.15** CZARNY MAT 1000,00  
**\*FIN.A** 1000,00  
**\*FIN.B** 1230,00





**ZBOC120..** WYLEWKA ŚCIENNA **L-150MM**  
**ZBOC121..** WYLEWKA ŚCIENNA **L-200MM**

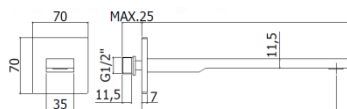

**-PAFFONI-**

<b>CR</b>	CHROM	<b>1150,00</b>
<b>*ST</b>	STAL SZCZOTKOWANA	<b>1900,00</b>
<b>*BO</b>	BIAŁY MAT	<b>1480,00</b>
<b>*NO</b>	CZARNY MAT	<b>1480,00</b>



**A590XL..** WYLEWKA KASKADOWA **L-120MM**

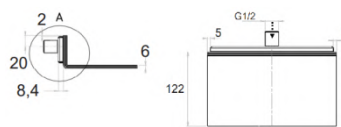

**-DANIEL-**



<b>CR</b>	CHROM	<b>1930,00</b>
-----------	-------	----------------



**A590XS..** WYLEWKA KASKADOWA

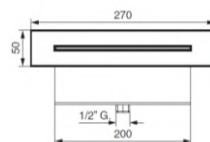

**-DANIEL-**



<b>CR</b>	CHROM	<b>1400,00</b>
-----------	-------	----------------



**A594XT..** WYLEWKA KASKADOWA

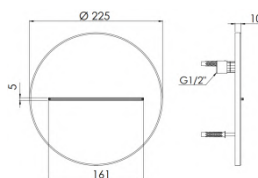

**-DANIEL-**



<b>CR</b>	CHROM	<b>1990,00</b>
-----------	-------	----------------



**CW4704..** WYLEWKA KASKADOWA WĄSKA **L-190MM**

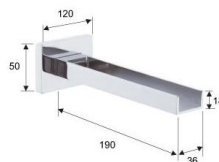

**-DANIEL-**



<b>CR</b>	CHROM	<b>1000,00</b>
<b>*FIN.A</b>		<b>1650,00</b>
<b>*FIN.B</b>		<b>2000,00</b>

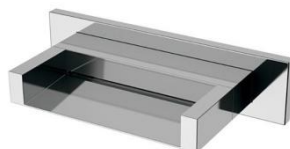

**CA4704..** WYLEWKA KASKADOWA SZEROKA **L-100MM**

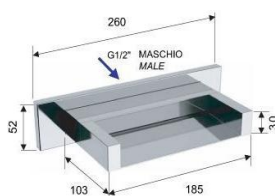

**-DANIEL-**



<b>CR</b>	CHROM	<b>2600,00</b>
<b>*FIN.A</b>		<b>4200,00</b>
<b>*FIN.B</b>		<b>5100,00</b>



**ZBOC039..** WYLEWKA STOJĄCA

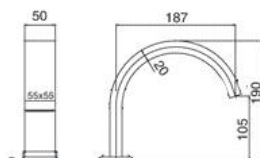

-PAFFONI-



CR

CHROM

950,00



**ZBOC032..** WYLEWKA STOJĄCA

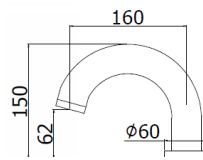

-PAFFONI-

CR

CHROM

460,00

\*BO

BIAŁY MAT

600,00

\*NO

CZARNY MAT

600,00

\*ST

STAL SZCZOTKOWANA

700,00

\*HG

ZŁOTY BŁYSZCZĄCY

1400,00



**A698CNM..** WYLEWKA STOJĄCA

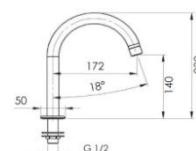

-DANIEL-

CR

CHROM

350,00

\*FIN.A

560,00

\*FIN.B

700,00



**C01029..** WYLEWKA ŚCIENNA L-210MM

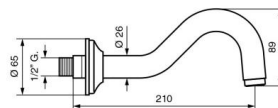

-EMMEVI-

CR

CHROM

300,00

\*NO

CZARNY MAT

435,00

\*CO

CHROM/ZŁOTO

435,00

\*CG

BIAŁY/ZŁOTO

500,00

BR

STARE ZŁOTO

435,00

\*RA

MIEDŹ SZCZOTKOWANA

435,00

\*OR

ZŁOTY BŁYSZCZĄCY

600,00



**4704..** WYLEWKA ŚCIENNA L-150MM

-DANIEL-

CR

CHROM

360,00



**C4704..** WYLEWKA KASKADOWA L-105MM



-DANIEL-

\*CR

CHROM

530,00



**S204706..**

WYLEWKA SUFITOWA L-1590MM

-DANIEL-

CR CHROM  
\*FIN.A  
\*FIN.B

5700,00  
9250,00  
11500,00



**K4702..**

WYLEWKA ŚCIENNA Z PRZEŁĄCZNIKIEM L-180MM

-DANIEL-

CR CHROM  
\*FIN.A  
\*FIN.B

450,00  
720,00  
900,00



**SK4702..**

WYLEWKA ŚCIENNA Z PRZEŁĄCZNIKIEM L-180MM

-DANIEL-

CR CHROM  
\*FIN.A  
\*FIN.B

700,00  
1200,00  
1400,00



**A00602..**

WYLEWKA 3/4" SDO BATERII ŚCIENNYCH

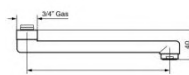

-EMMEVI-

L-12CM CHROM  
L-20CM CHROM  
L-25CM CHROM  
L-30CM CHROM

120,00  
130,00  
155,00  
190,00

# AKCESORIA



**ZSCAA050..**

KOREK UMYWALKOWY UNIWERSALNY **CLICK CLACK**

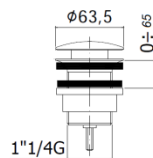

-AP-

<b>CR</b>	CHROM	<b>80,00</b>
<b>C</b>	CERAMICZNY BIAŁY	<b>130,00</b>
<b>NO</b>	CZARNY MAT	<b>120,00</b>
<b>ZŁ</b>	ZŁOTY BŁYSZCZĄCY	<b>460,00</b>
<b>.64</b>	MIEDŹ SZCZOTKOWANA	<b>260,00</b>
<b>.DP</b>	ZŁOTY SZCZOTKOWANY	<b>320,00</b>
<b>*FIN.A</b>		<b>260,00</b>
<b>*FIN.B</b>		<b>320,00</b>



**ZSCA050..**

KOREK UMYWALKOWY UNIWERSALNY **CLICK CLACK**

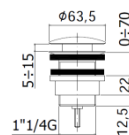

-PAFFONI-

<b>BO</b>	BIAŁY MAT	<b>205,00</b>
<b>NO</b>	CZARNY MAT	<b>205,00</b>
<b>ST</b>	STAL SZCZOTKOWANA	<b>240,00</b>
<b>MG</b>	GRAFITOWY	<b>205,00</b>
<b>RMSP</b>	MIEDŹ SZCZOTKOWANA	<b>430,00</b>
<b>HG</b>	ZŁOTY BŁYSZCZĄCY	<b>400,00</b>
<b>*HGSP</b>	ZŁOTY SZCZOTKOWANY	<b>430,00</b>



**V-1016..**

KOREK WANNOWY **CLICK CLACK**

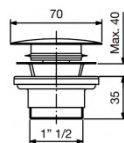

-VICARIO-

<b>*CR</b>	CHROM	<b>200,00</b>
<b>*BO</b>	BIAŁY MAT	<b>380,00</b>
<b>*NO</b>	CZARNY MAT	<b>380,00</b>
<b>*HG</b>	ZŁOTY BŁYSZCZĄCY	<b>400,00</b>
<b>*.64</b>	MIEDŹ SZCZOTKOWANA	<b>400,00</b>



**BO0595SP25K7..** SYFON UMYWALKOWY **SPACELESS** CHROM

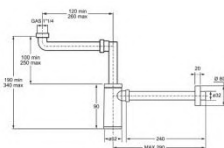

-BONOMINI-



<b>CR</b>	CHROM	<b>150,00</b>
-----------	-------	---------------



**BO2500IS32B0..** SYFON UMYWALKOWY **SPACELESS**

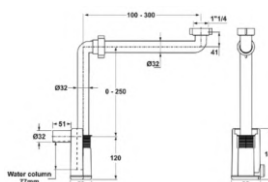

-BONOMINI-



<b>CR</b>	CHROM	<b>85,00</b>
-----------	-------	--------------

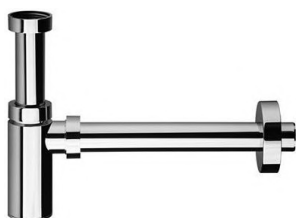

**BO0595..**

PÓŁSYFON UMYWALKOWY **MINIMAL** ABS+BRASS

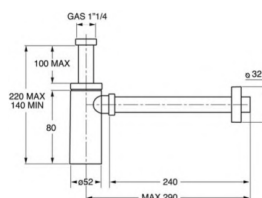

-BONOMINI-



<b>CR</b>	CHROM	<b>90,00</b>
-----------	-------	--------------

# AKCESORIA

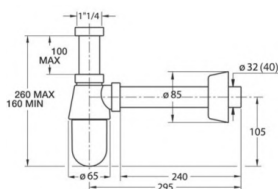
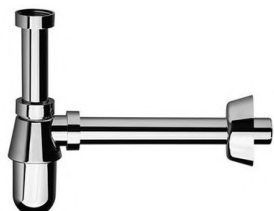

**BO0570..** PÓŁSYFON UMYWALKOWY **THERMO** ABS+BRASS **-BONOMINI-** **CR** CHROM **85,00**

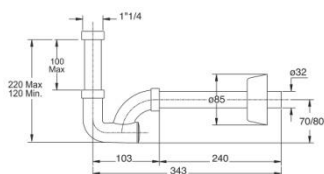

**BO0470..** PÓŁSYFON UMYWALKOWY **KAPPA** ABS+BRASS **-BONOMINI-** **CR** CHROM **90,00**

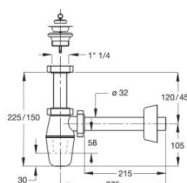

**BO2634..** SYFON UMYWALKOWY **BIAŁY** ABS **-BONOMINI-** **CR** CHROM **30,00**

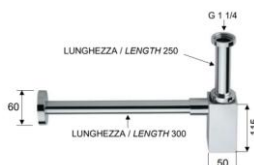

**CR**  
**\*FIN.A**  
**\*FIN.B**

CHROM

**350,00**  
**560,00**  
**700,00**

**A740..** PÓŁSYFON UMYWALKOWY METALOWY 1 1/4" **-DANIEL-**

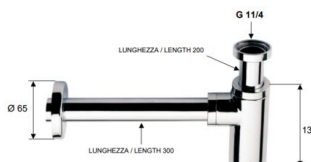

**CR**  
**.64**  
**.DP**  
**\*FIN.A**  
**\*FIN.B**

CHROM  
MIEDŹ SZCZOTKOWANA  
ZŁOTY SZCZOTKOWANY

**320,00**  
**260,00**  
**320,00**  
**500,00**  
**620,00**

**A750..** PÓŁSYFON UMYWALKOWY METALOWY 1 1/4" **-DANIEL-**

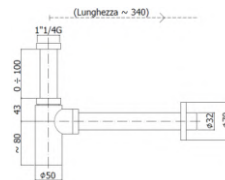

**CR**  
**\*BO**  
**NO**  
**ST**  
**MG**  
**RMSP**  
**HG**  
**\*HGSP**

CHROM  
BIAŁY MAT  
CZARNY MAT  
STAL SZCZOTKOWANA  
GRAFITOWY  
MIEDŹ SZCZOTKOWANA  
ZŁOTY BŁYSZCZĄCY  
ZŁOTY SZCZOTKOWANY

**220,00**  
**350,00**  
**350,00**  
**420,00**  
**350,00**  
**850,00**  
**800,00**  
**850,00**

**ZACC240..** PÓŁSYFON UMYWALKOWY METALOWY **-PAFFONI-**



**V-1011..**

SYFON WANNOWY CLICK CLACK **L-70CM**

-VICARIO-

<b>CR</b>	CHROM	<b>210,00</b>
<b>*BO</b>	BIAŁY MAT	<b>360,00</b>
<b>NO</b>	CZARNY MAT	<b>360,00</b>
<b>*HG</b>	ZŁOTY	<b>390,00</b>
<b>*64</b>	MIEDŹ SZCZOTKOWANA	<b>360,00</b>



**V-D6..**

SYFON WANNOWY Z NAPEŁNIENIEM **L-70CM**

-VICARIO-

<b>CR</b>	CHROM	<b>480,00</b>
<b>BO</b>	BIAŁY MAT	<b>750,00</b>
<b>NO</b>	CZARNY MAT	<b>750,00</b>
<b>ST</b>	STAL SZCZOTKOWANA	<b>800,00</b>
<b>HG</b>	ZŁOTY	<b>800,00</b>
<b>*.64</b>	MIEDŹ SZCZOTKOWANA	<b>800,00</b>



**A700..**

SYFON WANNOWY **L-50CM**

-DANIEL-

<b>CR</b>	CHROM	<b>340,00</b>
<b>.64</b>	MIEDŹ SZCZOTKOWANA	<b>260,00</b>
<b>.DP</b>	ZŁOTY SZCZOTKOWANY	<b>320,00</b>
<b>*FIN.A</b>		<b>550,00</b>
<b>*FIN.B</b>		<b>640,00</b>



**914/0**

PERLATOR WŁOSKI KRÓTKI

-IPIERRE-



**28,00**



**918/10**

PERLATOR WŁOSKI DŁUGI

-IPIERRE-



**32,00**



**GC1/2W**

GŁOWICA CERAMICZNA Z WŁOSKIM WIELOKLINEM

**45,00**



**ZA91100**

GŁOWICA CERAMICZNA WYSOKA **ø40MM**

**115,00**



**ZA91102**

GŁOWICA CERAMICZNA NISKA **ø40MM**

**115,00**



**ZA91103**

GŁOWICA CERAMICZNA WYSOKA  $\varnothing$ 35MM

115,00



**ZA91104**

GŁOWICA CERAMICZNA NISKA  $\varnothing$ 35MM

115,00



**ZA91400**

GŁOWICA CERAMICZNA  $\varnothing$ 25MM

175,00



**ZA91160**

GŁOWICA CERAMICZNA  $\varnothing$ 28MM

175,00



**ZDEV003**

PRZEŁĄCZNIK DO BATERII WANNOWYCH ŚCIENNYCH

130,00



**ZDEV007**

PRZEŁĄCZNIK DO BATERII WANNOWYCH 3-OTWOROWYCH

120,00



**ZDEV048**

PRZEŁĄCZNIK DO BATERII PODTYNKOWYCH 2-DROŻNYCH

180,00



**ZVIT028**

PRZEŁĄCZNIK CERAMICZNY  $\varnothing$ 35MM

180,00



**ZVIT089**

PRZEŁĄCZNIK CERAMICZNY DO BATERII 3-DROŻNYCH

**ZVIT090**

PRZEŁĄCZNIK CERAMICZNY DO BATERII 2-DROŻNYCH

320,00



**A83**

PERLATOR **WATER SAVING 50%** DO BATERII UMYWALKOWYCH **M24**

**A84**

PERLATOR **WATER SAVING 50%** DO BATERII WANNOWYCH **M28**



12,00



**ZAER006**

PERLATOR DO BATERII BIDETOWYCH



50,00

# WĘŻYKI

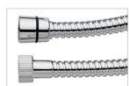

WĄŻ NATRYSKOWY METALOWY Z PODWÓJNYM OPLOTEM **CONIC**

	<b>INDEKS ZFLO003</b>	
<b>CR</b>	L-100CM (BEZ STOŻKA)	<b>35,00</b>
	<b>INDEKS 323S120</b>	
<b>CR</b>	L-120CM	<b>40,00</b>
	<b>INDEKS 1032150</b>	
<b>CR</b>	L-150CM	<b>45,00</b>



WĄŻ NATRYSKOWY **ROZCIĄGANY** **-TUCAI-**

	<b>INDEKS 4114</b>	
<b>CR</b>	L-150-175CM	<b>38,00</b>
	<b>INDEKS 2830</b>	
<b>CR</b>	L-175-230CM	<b>42,00</b>



**ZFLO071..** WĄŻ NATRYSKOWY **GUMOWY**

	<b>CHROM</b>	
<b>120</b>	L-120CM	<b>60,00</b>
<b>150</b>	L-150CM	<b>60,00</b>
	<b>CZARNY MAT</b>	
<b>120NO</b>	L-120CM	<b>140,00</b>
<b>150NO</b>	L-150CM	<b>145,00</b>
	<b>BIAŁY MAT</b>	
<b>150BO</b>	L-150CM	<b>145,00</b>
	<b>ZŁOTY</b>	
<b>150DO</b>	L-150CM	<b>220,00</b>



WĄŻ DO BATERII **1/2x15x1**

<b>618201</b>	L-150CM		<b>105,00</b>
<b>618202</b>	L-200CM		<b>140,00</b>
<b>ZFLO009</b>	L-150CM	PAFFONI	<b>165,00</b>
<b>ZFLO011</b>	L-150CM	NYLON	<b>65,00</b>



**940..** WĘŻYK ELASTYCZNY **-TUCAI-**

	<b>3/8x3/8</b>	<b>1/2x3/8</b>	<b>1/2x1/2</b>
<b>L-20 CM</b>	17,50	17,50	17,50
<b>L-30 CM</b>	21,00	21,00	21,00
<b>L-40 CM</b>	23,40	23,40	23,40
<b>L-50 CM</b>	24,70	24,70	24,70
<b>L-60 CM</b>	26,60	26,60	26,60
<b>L-70 CM</b>	27,80	27,80	27,80
<b>L-80 CM</b>	29,80	29,80	29,80
<b>L-100 CM</b>	33,00	33,00	33,00
<b>L-120 CM</b>	37,00	37,00	37,00



**DELTA..** WĘŻYK ELASTYCZNY DO BATERII **-TUCAI-**

	<b>10x1x3/8</b>	<b>10x1x1/2</b>	<b>8x1x3/8</b>	<b>12x1x3/8</b>
<b>L-40 CM</b>	19,00	19,00	-	30,00
<b>L-50 CM</b>	20,15	20,15	30,00	-
<b>L-60 CM</b>	21,60	21,60	-	-
<b>L-80 CM</b>	24,60	24,60	-	-



WĘŻYK PODŁĄCZENIOWY DO BOJLERÓW **TUCAI - TAQ ACB**

<b>201-30</b>	L-30CM	<b>50,00</b>
<b>201-40</b>	L-40CM	<b>55,00</b>
<b>201-50</b>	L-50CM	<b>67,00</b>



# WĘŻYKI



**RO** RURA ODPLYWOWA PRAŁKI -GO PLAST- 19,00



**SE..** SYFON ELASTYCZNY -GO PLAST- 32 32 13,00  
42 42 14,00



**N..** NYPEL MOSIĘŻNY -REMER- 3/8 CHROM 6,00  
1/2 CHROM 7,00  
3/4 CHROM 12,50  
1/2x3/8 CHROM 7,00  
3/4x1/2 CHROM 12,50



**P1/2..** PRZEDŁUŻKA MOSIĘŻNA 1/2" -REMER- L-10MM CHROM 9,00  
L-15MM CHROM 9,50  
L-20MM CHROM 11,00  
L-25MM CHROM 13,00  
L-30MM CHROM 15,00  
L-40MM CHROM 17,00  
L-50MM CHROM 20,00  
L-60MM CHROM 30,00



**P3/4..** PRZEDŁUŻKA MOSIĘŻNA 3/4" -REMER- L-15MM CHROM 12,00  
L-20MM CHROM 16,00  
L-30MM CHROM 27,00  
L-40MM CHROM 30,00  
L-50MM CHROM 37,00



**R..** REDUKCJA MOSIĘŻNA -REMER- 1/2x3/8 CHROM 9,00  
3/4x1/2 CHROM 10,00



**TR..** TRÓJNIK MOSIĘŻNY -REMER- 3/8 CHROM 16,00  
1/2 CHROM 18,00



**KN..** KOLANO NYFLOWE -REMER- 3/8 CHROM 13,00  
1/2 CHROM 17,00

# ZAWORY



ZAWÓR KĄTOWY Z FILTREM

-BIANCHI-

871	1/2 x 1/2	48,00
873	1/2 x 3/8	48,00
890	1/2 x 3/4	48,00



ZAWÓR KĄTOWY

-BENKISER-

7301212	1/2 x 1/2	30,00
7303800	1/2 x 3/8	27,00
7301234	1/2 x 3/4	33,00



ZAWÓR KĄTOWY Z FILTREM

-BENKISER-

7883812	1/2 x 3/8	85,00
---------	-----------	-------



ZAWÓR KĄTOWY 1/2x3/4x3/8

1271	GOPLAST	55,00
7281239	BENKISER	82,00



ZAWÓR PISUAROWY

-BENKISER-

6552180	CETUS – OD PRZODU	280,00
6702200	CETUS – OD GÓRY	425,00



8803001

ZAWÓR SPŁUCZKI WC 3/4"

-BENKISER-

555,00

# ZAWORY



ZAWÓR CZERPALNY

-BENKISER-

7201281	1/2"	50,00
7203482	3/4"	85,00



ZAWÓR LABORATORYJNY PODWÓJNY 1/2

-BIANCHI-

517 1/2	GWINT ZEWNĘTRZNY	108,00
518 1/2	GWINT WEWNĘTRZNY	108,00



ZAWÓR LABORATORYJNY POJEDYŃCZY 1/2 9MM

-BIANCHI-

512 1/2	GWINT ZEWNĘTRZNY	40,00
515 1/2	GWINT WEWNĘTRZNY	40,00



ZAWÓR LABORATORYJNY POJEDYŃCZY 1/2 14MM

-BIANCHI-

513 1/2	GWINT ZEWNĘTRZNY	40,00
516 1/2	GWINT WEWNĘTRZNY	40,00



ZAWÓR LABORATORYJNY KĄTOWY 1/2 9MM

-BIANCHI-

523 1/2	GWINT ZEWNĘTRZNY	52,00
525 1/2	GWINT WEWNĘTRZNY	52,00



ZAWÓR GAZOWY KULOWY

-BIANCHI-

455 1/2	1/2"	45,00
455 3/4	3/4"	55,00
455 1	1"	105,00

# ZAWORY



ZAWÓR CZERPALNY KULOWY

-REMER-

82 1/2	1/2"	40,00
82 3/4	3/4"	50,00
82 1	1"	90,00



KOŃCÓWKA ZAWORU CZERPALNEGO

-REMER-

350 1/2	1/2"	11,00
350 3/4	3/4"	13,00
350 1	1"	20,00



209Y

PODŁĄCZENIE 3/4F x 3/4M x 3/4M

REMER

45,00



ZAWÓR Z PRZEDŁUŻKĄ DO PODŁĄCZENIA PRAŁKI

PODWIR REMER  
7311234 BENKISER

90,00  
120,00



05.012.04

ZAWÓR CZERPALNY Z WYLEWKĄ I PODŁĄCZENIEM 3/4"

180,00



ZAWÓR GRZEJNIKOWY KĄTOWY

BIANCHI

407 1/2	38,00
407 3/8	33,00



ZAWÓR GRZEJNIKOWY PROSTY

BIANCHI

408 1/2	38,00
408 3/8	33,00

# ZAWORY



ZAWÓR GRZEJNIKOWY PROSTY

BIANCHI

407D 1/2  
407D 3/8

38,00  
33,00



ZAWÓR GRZEJNIKOWY PROSTY POWROTNY

BIANCHI

408D 1/2  
408D 3/8

38,00  
33,00



ZAWÓR PRZELOTOWY KULOWY W/W

REMER

36 1/2 1/2"  
36 3/4 3/4"  
36 1 1"  
36 1 1/4 1 1/4"  
36 1 1/2 1 1/2"

28,00  
35,00  
56,00  
90,00  
130,00



ZAWÓR PRZELOTOWY KULOWY W/Z

REMER

39 1/2 1/2"  
39 3/4 3/4"  
39 1 1"

28,00  
35,00  
56,00



ZAWÓR KULOWY Z PÓŁŚRUBUNKIEM

REMER

55 1/2 1/2"  
55 3/4 3/4"  
55 1 1"

33,00  
48,00  
78,00

# BATERIE NA PODCZERWIĘĆ



**1995260..**

WYLEWKA STOJĄCA IR

PRZEPŁYW **3,9 L/MIN**  
(DO WODY ZMIESZANEJ)

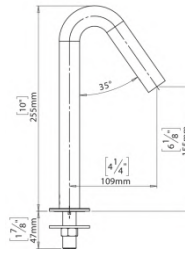

**-BENKISER-**

**CR** CHROM **1320,00**  
**NO** CZARNY MAT **1550,00**  
**\*DP** ZŁOTY SZCZOTKOWANY **1750,00**



**1991210..**

WYLEWKA STOJĄCA IR

(DO MYDŁA W PŁYNIE)

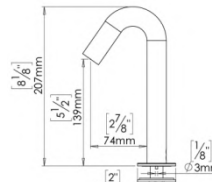

**-BENKISER-**

**CR** CHROM **1320,00**  
**NO** CZARNY MAT **1550,00**  
**\*DP** ZŁOTY SZCZOTKOWANY **1750,00**



**1992050..**

WYLEWKA ŚCIENNA IR

PRZEPŁYW **6,0 L/MIN**  
(DO WODY ZMIESZANEJ)

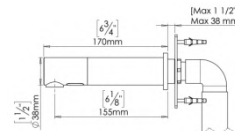

**-BENKISER-**

**\*CR** CHROM **1600,00**



**SEN30027..**

WYLEWKA STOJĄCA IR

(DO WODY ZMIESZANEJ)

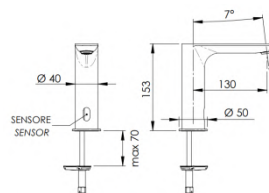

**-DANIEL-**

**\*CR** CHROM **1500,00**



**SEN30027L..**

WYLEWKA STOJĄCA IR

(DO WODY ZMIESZANEJ)

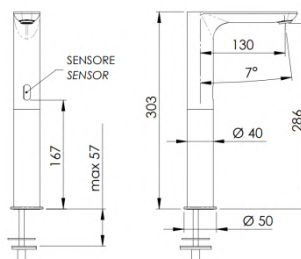

**-DANIEL-**

**\*CR** CHROM **1900,00**



CZAS PRZEPIYU 6-8 SEKUND

**TEM40010..**

BATERIA UMYWALKOWA STOJĄCA (DO WODY ZMIESZANEJ)

**\*CR**

CHROM

**340,00**



CZAS PRZEPIYU 6-8 SEKUND

**TEM40010M..**

BATERIA UMYWALKOWA STOJĄCA (Z REGULACJĄ TEMPERATURY)

**\*CR**

CHROM

**460,00**



CZAS PRZEPIYU 6-8 SEKUND

**TEM40030..**

ZAWÓR PRYSZNICOWY (DO WODY ZMIESZANEJ)

**CR**

CHROM

**270,00**



CZAS PRZEPIYU 6-8 SEKUND

**TEM40053..**

ZAWÓR PODTYNKOWY Z WYLEWKĄ

**\*CR**

CHROM

**280,00**



CZAS PRZEPIYU 6-8 SEKUND

**TEM40855..**

ZAWÓR PISAUROWY

**CR**

CHROM

**260,00**



**HIPRR922..** UCHWYT NA PAPIER TOALETOWY -DANIEL-

*CR	CHROM	190,00
*FIN.A		310,00
*FIN.B		390,00



**HIPS930..** SZCZOTKA WC WISZĄCA -DANIEL-

*CR	CHROM	240,00
*FIN.A		390,00
*FIN.B		480,00



**HIAP960..** HACZYK NA RĘCZNIK -DANIEL-

*CR	CHROM	130,00
*FIN.A		215,00
*FIN.B		270,00



**HIPS973..** WIESZAK L-400MM -DANIEL-  
**HIPS975..** WIESZAK L-600MM -DANIEL-

<b>INDEKS HIPS973</b>		
*CR	CHROM	240,00
*FIN.A		390,00
*FIN.B		490,00

<b>INDEKS HIPS975</b>		
*CR	CHROM	270,00
*FIN.A		440,00
*FIN.B		550,00



**HIPB940..** KUBEK WISZĄCY -DANIEL-

*CR	CHROM	170,00
*FIN.A		280,00
*FIN.B		340,00





**VGPR911..**

UCHWYT NA PAPIER TOALETOWY

-DANIEL-

\*CR CHROM

\*FIN.A

\*FIN.B

175,00

280,00

350,00



**HIPS930..**

SZCZOTKA WC WISZĄCA

-DANIEL-

\*CR CHROM

\*FIN.A

\*FIN.B

240,00

390,00

480,00



**VGAP960..**

HACZYK NA RĘCZNIK

-DANIEL-

\*CR CHROM

\*FIN.A

\*FIN.B

100,00

160,00

200,00



**VGPS973..**

WIESZAK L-400MM

-DANIEL-

\*CR CHROM

\*FIN.A

\*FIN.B

INDEKS VGPS973

290,00

470,00

580,00

**VGPS975..**

WIESZAK L-600MM

-DANIEL-

\*CR CHROM

\*FIN.A

\*FIN.B

INDEKS VGPS975

310,00

490,00

610,00



**VGPB940..**

KUBEK WISZĄCY

-DANIEL-

\*CR CHROM

\*FIN.A

\*FIN.B

225,00

360,00

450,00



**VGDI954..**

DOZOWNIK MYDŁA WISZĄCY

-DANIEL-

\*CR CHROM

\*FIN.A

\*FIN.B

315,00

500,00

625,00



**AD001..**

MYDELNICZKA WISZĄCA

-EMMEVI-

<b>*CR</b>	CHROM	<b>510,00</b>
<b>*NO</b>	CZARNY MAT	<b>540,00</b>
<b>*TS</b>	TUSCAN (BRAZ SZCZOT.)	<b>1150,00</b>



**AD002..**

KUBEK WISZĄCY

-EMMEVI-

<b>*CR</b>	CHROM	<b>510,00</b>
<b>*NO</b>	CZARNY MAT	<b>540,00</b>
<b>*TS</b>	TUSCAN (BRAZ SZCZOT.)	<b>1100,00</b>



**AD003..**

SZCZOTKA WC STOJĄCA

-EMMEVI-

<b>*CR</b>	CHROM	<b>750,00</b>
<b>*NO</b>	CZARNY MAT	<b>800,00</b>
<b>*TS</b>	TUSCAN (BRAZ SZCZOT.)	<b>1650,00</b>



**AD006..**

HACZYK NA RĘCZNIK

-EMMEVI-

<b>*CR</b>	CHROM	<b>280,00</b>
<b>*NO</b>	CZARNY MAT	<b>300,00</b>
<b>*TS</b>	TUSCAN (BRAZ SZCZOT.)	<b>620,00</b>



**AD007..**

UCHWYT NA PAPIER TOALETOWY

-EMMEVI-

<b>*CR</b>	CHROM	<b>430,00</b>
<b>*NO</b>	CZARNY MAT	<b>470,00</b>
<b>*TS</b>	TUSCAN (BRAZ SZCZOT.)	<b>940,00</b>



**AD009-435..**

WIESZAK L-435MM

-EMMEVI-

**AD009-565..**

WIESZAK L-565MM

-EMMEVI-

<b>INDEKS AD009-435</b>		
<b>*CR</b>	CHROM	<b>620,00</b>
<b>*NO</b>	CZARNY MAT	<b>640,00</b>
<b>*TS</b>	TUSCAN (BRAZ SZCZOT.)	<b>1360,00</b>

<b>INDEKS AD009-565</b>		
<b>*CR</b>	CHROM	<b>660,00</b>
<b>*NO</b>	CZARNY MAT	<b>680,00</b>
<b>*TS</b>	TUSCAN (BRAZ SZCZOT.)	<b>1430,00</b>



**AD011..**

DOZOWNIK MYDŁA WISZĄCY

-EMMEVI-

<b>*CR</b>	CHROM	<b>770,00</b>
<b>*NO</b>	CZARNY MAT	<b>790,00</b>
<b>*TS</b>	TUSCAN (BRAZ SZCZOT.)	<b>1700,00</b>